

Design and Implementation of a Hotel Reservation Back-end
Application with Customized
Web Service Support

By

KYRIAKOS V. KALKANIS

MASTER THESIS

DEPARTMENT OF ELECTRICAL AND COMPUTER ENGINEERING
SCHOOL OF ENGINEERING

HELLENIC MEDITERRANEAN UNIVERSITY

2023



Supervising Professor:

Konstantinos Aivalis

Dedication

I would like to dedicate my master thesis to my beloved grandfather Panagiotis Kalkanis.

Acknowledgments

I would like to thank my supervisor Dr. Aivalis Konstantinos for the guidance he provided me during my master's thesis.

I would also like to thank my family for their support and advice throughout my studies. I would also like to thank Theodora and Manos.

Abstract

There is no doubt that technology is an integral part of our lives and directly affects our everyday life since it finds use in all fields of science and beyond. The internet and computers have aided people in many ways, including communication, education, entertainment, and other aspects of their lives. However, these are not the only ways technology can improve our lives.

Websites and mobile applications are important technological creations that, when combined with electronic devices, are the means by which people carry out their daily tasks and manage their businesses. Nowadays more and more people who own businesses resort to setting up websites or mobile applications in order to manage them more productively and effectively. In this way, technology gives people the opportunity to save time and money as they can manage everything through a single website or application. To put it differently, they don't have to worry about all those complex processes that used to be done manually.

In recent years, there has been a significant demand for the development of online applications in the hotel sector, which has benefited the economies of several countries as a result of tourism, and as a result, there is an increased demand.

In this master thesis, a Property Management System (PMS) for hotel management was designed and implemented using Spring Boot for the back end and AngularJS for the front end. The purpose of this master thesis is the creation of a web application that will simplify and speed up hotel management. More specifically, connected users depending on their role in the hotel will have access to specific parts of the application. The most important features of this web application are the reservation system, contract creation for tour operators, pricing, the display of some statistics with the help of charts, as well as the development of a customized web service that enables real-time communication between this PMS and a booking application for the online room selling.

Σύνοψη

Δεν υπάρχει αμφιβολία ότι η τεχνολογία αποτελεί αναπόσπαστο κομμάτι της ζωής μας και επηρεάζει άμεσα την καθημερινότητά μας αφού βρίσκει χρήση σε όλους τους τομείς της επιστήμης και όχι μόνο. Η έλευση του διαδικτύου και των υπολογιστών έχει συμβάλλει καταλυτικά στην διευκόλυνση της ανθρώπινης επικοινωνίας, και στην εξέλιξη της εκπαίδευσης, της ψυχαγωγίας και γενικά σε κάθε πτυχή της ανθρώπινης ζωής. Ωστόσο, αυτοί δεν είναι οι μόνοι τρόποι με τους οποίους η τεχνολογία μπορεί να κάνει τη ζωή μας πιο εύκολη.

Μερικές πολύ σημαντικές πτυχές της τεχνολογίας είναι οι ιστοσελίδες και οι εφαρμογές για κινητά που σε συνδυασμό με ηλεκτρονικές συσκευές αποτελούν το μέσο με το οποίο οι άνθρωποι εκτελούν τις καθημερινές τους εργασίες και διαχειρίζονται τις επιχειρήσεις τους. Στις μέρες μας όλο και περισσότεροι άνθρωποι που έχουν επιχειρήσεις καταφεύγουν στη δημιουργία ιστοσελίδων ή εφαρμογών για κινητά προκειμένου να τις διαχειρίζονται πιο παραγωγικά και αποτελεσματικά. Με αυτόν τον τρόπο, η τεχνολογία δίνει στους ανθρώπους την ευκαιρία να εξοικονομήσουν χρόνο και χρήματα, καθώς μπορούν να διαχειριστούν τα πάντα μέσω μιας ιστοσελίδας ή εφαρμογής. Με άλλα λόγια, δεν χρειάζεται να ανησυχούν για όλες εκείνες τις περίπλοκες διαδικασίες που παλαιότερα γίνονταν χειροκίνητα.

Ένας από τους τομείς στους οποίους έχει σημειωθεί σημαντική ζήτηση για την ανάπτυξη διαδικτυακών εφαρμογών τα τελευταία χρόνια είναι ο χώρος των ξενοδοχείων, ο οποίος λόγω του τουρισμού έχει συμβάλλει θετικά στην οικονομία αρκετών χωρών .

Σε αυτή τη μεταπτυχιακή εργασία, σχεδιάστηκε και υλοποιήθηκε μια διαδικτυακή εφαρμογή PMS (Property Management System), για τη διαχείριση ξενοδοχείων χρησιμοποιώντας Spring Boot για το back end κομμάτι και AngularJS για το front end κομμάτι. Σκοπός της παρούσας διπλωματικής εργασίας είναι η δημιουργία μιας διαδικτυακής εφαρμογής που θα απλοποιεί και θα επιταχύνει τη διαχείριση ξενοδοχείων. Πιο συγκεκριμένα, οι συνδεδεμένοι χρήστες ανάλογα με τον ρόλο τους στο ξενοδοχείο θα έχουν πρόσβαση σε συγκεκριμένο περιεχόμενο της εφαρμογής. Οι πιο σημαντικές λειτουργίες αυτής της διαδικτυακής εφαρμογής είναι το σύστημα κρατήσεων, η δημιουργία συμβολαίων για τουριστικούς πράκτορες, η τιμολόγηση, η εμφάνιση στατιστικών στοιχείων με τη βοήθεια γραφημάτων, καθώς και η δημιουργία ενός customized web service που επιτρέπει την επικοινωνία σε πραγματικό χρόνο μεταξύ του συγκεκριμένου PMS με εφαρμογή booking για την πώληση δωματίων στο διαδίκτυο.

Table Of Content

Dedication.....	1
Acknowledgments.....	2
Abstract	3
Σύνοψη	4
List Of Tables.....	10
1 Introduction.....	11
1.1 Synopsis.....	12
1.2 Motivation.....	13
1.3 Objectives.....	14
1.4 Outline.....	14
2 Background.....	16
2.1 Information And Communication Technologies (ICTs)	16
2.2 E-tourism.....	17
2.3 Property Management Systems (PMS).....	19
2.3.1 Definitions.....	19
2.3.2 Technological Advancement.....	19
2.3.3 Features & Functionalities.....	20
2.3.4 Benefits Of PMS	21
2.3.5 Cloud-Based Vs Desktop-Based PMS.....	22
2.3.6 Main Modules of PMS.....	23
2.4 State Of The Art Implementations.....	24
2.4.1 inroad Property Management System	24
2.4.2 Cloudbeds Property Management System.....	24
2.4.3 OPERA Cloud Property Management.....	25
2.4.4 Preno Hotel Management System	25
3 RESERVE_IT System Analysis and Design	27
3.1 RESERVE_IT Textual Analysis.....	27
3.2 System Analysis	28
3.2.1 System Requirement Analysis and System Requirement Diagram.....	28
3.2.2 Backend Requirement Diagram	31
3.2.3 Frontend Requirement Diagram	31
3.2.4 Database Requirement Diagram.....	32
3.2.5 Role Requirement Analysis and Requirement Diagrams.....	33
3.2.6 Admin Requirement Diagram	35
3.2.7 Housekeeping Staff Requirement Diagram	36

3.2.8 Bar / Restaurant Staff Requirement Diagram.....	37
3.3 RESERVE_IT System Design	37
3.3.1 System Component Diagram.....	38
3.3.2 Use Case Diagram	39
3.3.3 Sequence Diagrams.....	40
3.4 Extended Entity Relationship Diagram (EER).....	43
3.5 Technologies used to develop RESERVE_IT.....	43
3.5.1 AngularJS	44
3.5.2 Spring Boot	44
3.5.3 MySQL Database	45
4 Pilot Implementation.....	46
4.1 RESERVE_IT Home Page.....	46
4.2 Sign Up – Login Forms.....	47
4.3 Admin Use Case Scenario.....	48
4.3.1 Hotel Specifics Module.....	48
4.3.2 Room Type Module.....	49
4.3.3 Room Module	50
4.3.4 Tour Operators Module.....	52
4.3.5 Tour Contracts Module	53
4.3.6 Reservation Module	57
4.3.7 Check-In Operations Module.....	60
4.3.8 Availability Module	65
4.3.9 Additional costs for extra services	66
4.3.10 Check Out Operations	67
4.3.11 Check Out Tour Operators Board.....	70
4.3.12 Statistics Module.....	71
4.3.13 Customer Module	72
4.4 Housekeeping Staff Use Case Scenario.....	72
4.4.1 Housekeeping Module	72
4.4.2 Room Status Update	73
4.5 Bar / Restaurant Staff Use Case Scenario	73
4.5.1 Room Module – Charge Additional Services	73
4.6 User Profile.....	74
5 Customized Web Service	75
6 Conclusion And Future Work	80
6.1 Conclusion.....	80

6.2 Future Work	80
References	82

List of Figures

Figure 1 ICT Basic Components	17
Figure 2 PMS Options	21
Figure 3 System Requirement Diagram.....	30
Figure 4 Backend Requirement Diagram.....	31
Figure 5 Frontend Requirement Diagram.....	32
Figure 6 Database Requirement Diagram	33
Figure 7 Admin Requirement Diagram.....	36
Figure 8 Housekeeping Staff Requirement Diagram.....	37
Figure 9 Bar / Restaurant Staff Requirement Diagram	37
Figure 10 System Component Diagram.....	38
Figure 11 System Use Case Diagram	39
Figure 12 Admin Sequence Diagram (a).....	40
Figure 13 Admin Sequence Diagram (b).....	41
Figure 14 Housekeeping Staff Sequence Diagram	42
Figure 15 Bar / Restaurant Staff Sequence Diagram.....	42
Figure 16 EER Diagram	43
Figure 17 Database Connection & Hibernate	45
Figure 18 Home Page	46
Figure 19 Sign-Up Form.....	47
Figure 20 Log-In Form	47
Figure 21 Hotel Specifics Module (Add Hotel Specifics).....	48
Figure 22 Edit Hotel Specifics.....	48
Figure 23 Update Hotel Specifics	49
Figure 24 Create Room Types.....	49
Figure 25 Room Type Added Successfully	50
Figure 26 Room Types List.....	50
Figure 27 Create Rooms From	51
Figure 28 Room Form Completion	51
Figure 29 Room List.....	52
Figure 30 Tour Operator Creation.....	52
Figure 31 Tour Operator List.....	53
Figure 32 Error Creating Tour Operator	53
Figure 33 Tour Contract Creation	54
Figure 34 Tour Contracts List.....	54
Figure 35 Add Contract Types to A Contract	55
Figure 36 Contract Room Type CRUD Functions.....	55
Figure 37 Self Hotel Add New Contract.....	56
Figure 38 Self Contract Add Room Type.....	56
Figure 39 Update Contract	57
Figure 40 Error Creating Contract With Same Or Overlapping Dates	57
Figure 41 Error Creating Contract With Same Or Overlapping Dates	58
Figure 42 List Of Reservations	58
Figure 43 Add Reservation Types to A Reservation	59
Figure 44 View Reservation Types	59
Figure 45 There is no corresponding contract error message.....	60
Figure 46 There is no availability for given dates error.....	60

Figure 47 Check-In Board	61
Figure 48 Arrival Room Types	61
Figure 49 Check-In Customer Form.....	62
Figure 50 Complete Check-Ins	62
Figure 51 Arrival Status Changed From Pending To Checked In.....	63
Figure 52 View Check-Ins Per Room Type	63
Figure 53 Daily Charge Has Not Carried Out.....	64
Figure 54 Successful Daily Charge.....	64
Figure 55 Incomplete Daily Charge	64
Figure 56 Overbooking	65
Figure 57 Availability By Room Type	65
Figure 58 Availability By Room Number.....	66
Figure 59 Charge Additional Costs	66
Figure 60 Check-Out Board.....	67
Figure 61 View Reservation Types To Check Out.....	67
Figure 62 List Of Rooms To Check Out	68
Figure 63 Preview Receipts.....	68
Figure 64 Expenses Preview & Checkout.....	69
Figure 65 Checked Out Reservations	69
Figure 66 Extra Services & Overnight Stays Receipts	70
Figure 67 List Of Tour Operators To Check-Out.....	70
Figure 68 Full Payout.....	71
Figure 69 Revenue Per Month And Year Statistic	71
Figure 70 Visitors Per Month And Year Statistic	71
Figure 71 Customer Module	72
Figure 72 Housekeeping Module	72
Figure 73 Update Room Status	73
Figure 74 Extra Service Charge On Room And Customer	73
Figure 75 User Profile.....	74
Figure 76 Get Availability Endpoint.....	75
Figure 77 Save Reservation Endpoint.....	76
Figure 78 Available Hotels Booking System.....	76
Figure 79 Available Rooms Of Hotel Booking System	77
Figure 80 Payment Booking System.....	77
Figure 81 Successful Reservation Booking System	77
Figure 82 List of Reservations	78
Figure 83 View Reservation Types	78
Figure 84 Architecture of customized web service support.....	79

List Of Tables

Table 1 System Requirement List.....	30
Table 2 System Requirement List Based On Different System Roles	35

1 Introduction

Nowadays, there is no doubt that technology has made our lives more comfortable. It is almost impossible to think what our lives would be like without it since it has had a significant impact on every sector. The most important sectors that have been positively affected by the advent of technology are medicine, education, the economy, automobile industries, agriculture, and many more. Computers, laptops, tablets, smartphones, and in general anything connected to the internet that can be used as a medium so that we can not only search for any information we want but also use it to make our lives easier by automating what was previously done manually are examples of technological achievements.

With the development of the Internet and the World Wide Web (WWW), the way people interact, work, communicate and learn has changed and thus their lives have changed to a huge extent. Now using an electronic device and having an internet connection anyone can access a huge amount of information. Every day we access websites, web applications, and mobile applications in order to see and interact with the content we are interested in.

When World Wide Web (WWW) was created, the first stage of web growth was Web 1.0. In Web 1.0, static web pages were created for readers and thus the sharing of information on the internet began. Of course, the functions that could be performed were much simpler than they are today. Some of these functions were exchanging e-mails, playing music, and reading the news. There was no interaction and contribution with the content but for website owners back then it was sufficient that they could share content with their readers. Then in Web 2.0 people could interact with each other, share content freely either on blogs or social media, shop online, play, get educated, etc. That's when the internet's background changed. Some of the most well-known types of web applications that we encounter in our daily lives are audio, e-learning, games, e-mail, e-commerce, blogging, communication, collaboration, etc. Some examples of well-known Web 2.0 applications are Facebook, YouTube, Flickr, Wikipedia, and Scribd. Web 3.0 is a new era where it is still in progress, in which the semantic web combined with artificial intelligence transforms the web into a database. So computers will be able to perceive as well as analyze human requests and respond accurately [1].

Compared to desktop applications, web applications are preferred for several reasons and web 2.0 applications will eventually replace them entirely. The main reason is that, unlike desktop applications which depend on the operating system and the capabilities of

the electronic device they run on, web applications can be used by older, newer, slow, and fast electronic devices [2].

As the tourism industry evolves, there is a significant demand for the creation of systems that will facilitate both the tasks of the hotel staff and the customers themselves since all processes will be carried out without unnecessary delays compared to the traditional way used in earlier years. These systems are called Property Management Systems (PMS) and the flow they follow is the continuous exchange of information in a continuous process within an organization [3][4]. The main benefit of these systems is that the information is shared among staff members according to their role so that everyone is informed about the tasks they have to perform. Another advantage of such systems is the easy management of rooms, reservations, and invoicing. Some well-known PMS are Opera Enterprise solution, Micros Fidelio, and Amadeus PMS. At the same time, it is of utmost necessity for hotel owners to ensure that all of their hotel rooms are fully booked. Therefore, the interconnection and continuous communication of PMS systems with distribution channels used for renting rooms such as Booking.com, Expedia.com, etc. is of paramount importance.

PMS systems are nowadays of vital importance and a real necessity for hotels since in many cases their survival is based on them as well as maintaining their market share [5-8]. It is important to mention that during the COVID-19 pandemic, there was and continues to be a draw in hotel human resources, resulting in hotel under-functionality [9]. Therefore, the development of PMS systems is a one-way street, since with their use the work of the hotel staff is automated using computers, mobile devices, and tablets that would otherwise have to be done in person, thus avoiding contacts, and protecting them from getting sick [10].

Consequently, PMS systems can be used as a powerful tool for the proper operation and management of hotel accommodations, optimizing and automating tasks that were done traditionally in the past years. In the context of this master thesis, we will deal with the design and development of a PMS web application for the management of hotel accommodations as well the implementation of an API for the communication of the PMS with channel managers for booking rooms from other booking engines.

1.1 Synopsis

PMS web applications are extremely useful for the proper management of hotels since the information is shared directly within the hotel and all staff remains informed of any changes. This results in the orderly operation of the hotel since all work is carried out immediately and without any of the troubles that existed in previous years.

There is no doubt that the internet is both a daily necessity and a means to carry out our daily work activities. Nowadays, we all have access to mobile devices such as tablets, laptops, and mobile phones. So there is a need for cloud web applications that make our everyday life easier. Compared to desktop applications, cloud-based applications are preferred because all support is provided online directly and does not need a connection to a server located within the hotel. Furthermore, their cost is lower, there is no need to install extra software on the devices that use the application, and it can be accessed from any device with an internet connection. Their main positive features are Cost Containment, Immediacy, Availability, Scalability, Efficiency, and Resiliency [11].

In this master thesis, we will deal with the creation of a responsive web application PMS (Property Management System) with Customized Web Service Support through which hotel owners will be able to register in order to manage their hotels in a fast and optimal way and also to book their hotel rooms through other booking engines. The system is divided into 2 parts: the back-end is built with the help of a Java framework called Spring. The other part is the front-end which was built with the help of AngularJS which is a JavaScript framework but also with the help of other libraries provided by node.js. The database used to store and access the data is the MySQL database, while for its interface with the back-end part, the Hibernate Framework was used, which connects the objects created by the object-oriented Java programming language to relational database tables. For their continuous communication, the back-end part communicates with the database when it receives requests from the front-end through endpoints (Rest APIs) and responds accordingly.

1.2 Motivation

The motivation for completing my master thesis was the development of a responsive PMS web application that will allow hotel owners and their staff to manage the tasks included within the accommodation. Also, with the use of a Rest API, hotels will be able to book their rooms through other booking engines, for example, Booking.com and Expedia.com. My influence is the use of new and modern technologies such as Spring boot and AngularJS which are Java and JavaScript frameworks respectively. My main goal is my involvement with full-stack web development as well as the trends of new technologies used for this purpose. This PMS system will help its users to automate and oversimplify tasks within the hotel compared to outdated ways they used in the past years.

1.3 Objectives

As has already been mentioned, in this master thesis we will deal with the design and implementation of a Property Management System (PMS) which aims to help the hotel staff to complete all the tasks required for the proper management of the hotel. In more detail, a hotel member can register as either an admin to gain access to all dashboard features or as a hotel staff to gain access to certain but not all of the system's features. An administrator has the authority to create room types and rooms, make bookings, create new contracts for tour operators, access room and customer information, view statistics, have full access to personal customer charges (such as bar expenses), overnight stays, etc. On the other hand, users with hotel staff rights have access to information about rooms, such as whether or not a room needs to be cleaned, and lastly, users with bar/restaurant staff privileges can charge the customers' accounts for any additional hotel services.

Regarding the source code of the master thesis, it is open source and anyone can find the source code for both Back-end and Front-end on my GitHub [profile](#). The way I worked on my master's thesis was straightforward. First, the system requirements were determined for the implementation of the backend and database creation, then some mockups for the front-end part of the application followed, and finally, the design and implementation of the system took place. Throughout the preparation of my master's thesis, I had the support, resources, and facilities required to fulfill it.

1.4 Outline

The master thesis is divided up into the following list of sections, each of which includes a brief description.

Section 1: *Introduction.* This section covers the impact of technology on our lives throughout history, including the Internet, the World Wide Web (WWW), websites, and web applications, as well as the significance of property management systems (PMS) in the hotel industry. In addition, the Synopsis, Motivations, Objectives, and Outline of this master thesis are also included.

Section 2: *Background.* This section covers the theoretical background of property management systems (PMS). More specifically, the concepts of ICTs and E-Tourism are analyzed, as well as their impact on the hotel industry. The comparison between cloud-

based and desktop PMS is followed by an analysis of terminology, technological advancements, benefits, and characteristics of Property Management Systems.

Section 3: *RESERVE_IT System Analysis & Design.* This section covers the architectural design of the system. The system analysis and design, system and role requirements, and several diagrams, including requirement diagrams, component diagrams, sequence diagrams, use case diagrams, and EER diagram, are all covered in further detail. Furthermore, the technologies used in the implementation of the project are also mentioned and analyzed.

Section 4: *Pilot Implementation.* This section introduces the application developed for the requirements of this master's thesis. More specifically, the application's functionality scenarios are presented depending on the various user roles that have privileges to use the application.

Section 5: *Customized Web Service.* In this section, the customized web service support provided for the communication and sale of rooms will be analyzed. More specifically, the communication protocol that was created for continuous communication and booking rooms through a booking application will be discussed.

Section 6: *Conclusion And Future Work.* The last section covers the results and future work of this master's thesis.

2 Background

As previously stated, the development of a Property Management System (PMS) for hotels will be the focus of this master thesis. In this section, we will deal with the theoretical background of this work. Some terms and technologies that have contributed significantly to the hotel industry will be discussed and are worth mentioning. First, we will review the benefits that information and communication technologies (ICTs) have contributed to the hotel industry through other research. Then, we will deal with the term E-Tourism and then there will be a discussion about state-of-the-art implementations concerning hotel management systems.

2.1 Information And Communication Technologies (ICTs)

There is no doubt that information and communication technologies (ICTs) have contributed positively to the operation of both the tourism sector and the hotel industry [12], leading to large changes and offering great opportunities in terms of the evolution of the hotel and tourism industry [13]. As a consequence, hotels have made significant investments in ICTs [14] to satisfy both their management and organizational needs as well as those of their customers [15].

According to [16], the term "ICTs" refers to technologies that combine Internet Technology (IT) with fast communication links that transmit sound, video, and data, while also this term refers to telecommunication services combined with hardware and software devices that are used to store, protect, alter, send and transmit data and information [17]. ICTs are split into two categories, according to a work: (1) Information and Communication Infrastructure (ICI), which deals with telecommunications systems and networks, and (2) ICT services, such as audio, internet, and e-mail combined with hardware and software for storing, processing, and displaying data [18]. The fundamental components of ICT are depicted in Figure 1 below, and as can be seen, these components are directly connected to the definitions of ICT provided above.



Figure 1 ICT Basic Components [18]

Despite being used in the hotel industry since the late 1970s, ICT technologies like reservation systems haven't played a significant role or made a great impact until the early 1990s [19]. Numerous researchers concur that countries adopting ICTs can experience considerable financial benefits [20]. Many European and American hotels have seen significant revenue benefits thanks to the following systems - (ICT technologies):

- PMS (Property Management System)
- CRS (Computer Reservation System)
- ERP (Enterprise Resource Planning)
- CRM (Customer Relation Management)
- SCM (Supply Chain Management)
- KMS (Knowledge Management System)
- OAS (Office Automation System)

It is also worth mentioning that, according to various studies, third-world countries have been negatively affected in terms of the hotel sector either due to the lack of guidance for the implementation of ICTs or due to the lack of organizational methods [21][22]. As a result, modern ICT adoption is crucial for the hotel business, both in terms of economy and organization as well as customer service.

2.2 E-tourism

Thanks to the digitalization of traditional tourism, which arose to fill many demands in

the hotel, tourism, and travel sectors, e-tourism is now a reality and not something that will happen in the near future. The term "e-tourism" is a reasonable addition to the already existing terminology such as "e-business", "e-commerce", "e-marketing" and "e-service" due to the global growth in tourism and the needs appearing in the hotel industry. The concept of tourism combined with the letter "e" stands for the economic benefits that can bring to both the hotel and travel industry as a consequence of the rapid development of tourism, in the digital era we live in. Of course, here it is worth mentioning the importance of technology and the Internet, which in combination with hotel-tourism systems can have a substantial positive impact on the economy, management, and the organization of the hotel industry [23].

The term "e-tourism" combines the ICTs discussed in the previous subsection with advances in technology and of course the use of the internet. According to [24] e-tourism is defined as a combination of ICT technologies that aims to build and maintain business relationships in the tourist and travel sectors through the Internet in order to provide services to customers. Based on another research, the term "e-tourism" is part of "e-commerce" and is defined as the provision of software and other systems for the easiest and fastest booking, which is something that involves both the hotel and travel sectors [25]. The definition that is mentioned most frequently, however, refers to the digitalization of classical tourism processes and service delivery in the catering, hotel, travel, and tourism industries [26]. In the same study, the term "e-tourism" concerns all business-related processes, including e-commerce, e-marketing, e-accounting, and procedures for e-strategy, e-planning, and e-management in all areas of the travel and tourism industry, including transportation, leisure, tour operators and travel agencies.

The systems that have benefited the hotel and tourism industries are numerous. The most well-known systems are OTAs (Online Travel Agency Systems) Booking.com, Expedia.com, etc, which, either exclusively or through social media advertising such as Facebook, or by directing users to hotel websites, can assist customers in making bookings and assist hoteliers in "selling" rooms [27]. Additionally, systems that are available to customers for direct communication with tour operators are included in the literature, and they benefit both the tourism and travel industries [28].

The digitization of the traditional tourism, hotel, and travel sector with the help of technology has contributed significantly to the e-business industry and has benefited both consumers and the abovementioned industries by saving time and automating manual tasks.

2.3 Property Management Systems (PMS)

2.3.1 Definitions

With the increase in tourism and therefore visitors the need to create systems to manage, organize and assign tasks to staff in an optimal and automated way is constantly increasing. The most common type of hotel management system is called a Property Management System (PMS), which is defined as the collection of software and applications that directly address the front office and back office operations of a hotel, such as room status, housekeeping, reservation management, accounting, check-in, and check-out, etc. [29]. Another definition that emerges from the literature is the continuous exchange of information in a continuous process within an organization [3][4]. According to a more general definition, PMS is a collection of computer software and hardware components used to manage a hotel [30]. A PMS system is thus a hotel's "brains" and the primary data infrastructure for reservations, revenue, visitors, etc.

2.3.2 Technological Advancement

The first Property Management System (PMS) was available on the market in the 1980s, even though the concept first surfaced in the 1970s [31]. Initially, this technology was only utilized to order meals and drinks for hotel guests as well as handle front desk duties. Despite the fact that many years have passed since then, the primary goal of PMS continues to be the delegation of duties to staff as well as the automation and optimization of internal hotel procedures that were previously carried out in the antiquated manual way.

Of course, when these systems were first established, people were not satisfied because the technology was unstable and antiquated. Also, there were a number of delays every time the system required to add any new capability. Another drawback is that back then, hoteliers couldn't afford a PMS due to the high cost. However, over time and with the advancement of technology that comprises both hardware and software, all these issues were resolved, leading to the exceptional functions that are now present in these systems[32].

Some other alternatives that have been used besides the PMS are the use of paper where one can note the reservations and of course, it is an outdated method as well as the use of Microsoft Excel to note reservations, check-ins, check-outs, creating statistics with the help of graphs, etc. [33][34]. The above is the consequence of either a lack of knowledge or financial resources to build a PMS [34].

Undoubtedly, with the advancement of technology, Property Management Systems have evolved, and become more modern, they now have more functions than older systems and of course, they are in the cloud where they can be accessed from many mobile devices at the same time for continuous communication and assigning tasks to staff inside the hotel [11].

2.3.3 Features & Functionalities

One of the crucial ICT systems assisting the operations of the hotel industry is the PMS and its features and functionalities vary across Property Management Systems [4][33]. The most common functions that these systems have are the following [33] :

- Booking Management
- Check-in and Check-out of guests
- Customer data handling
- Management of front desk operations
- Management of back-office operations
- Channel management
- Housekeeping management
- Revenue management
- Reporting and Analytics
- Order and Service management

These systems are developed and delivered to the end customer as modules so that they can be easily modified and additional features added as needed [4]. These extra features can support sector-specific activities, like revenue management at a basic level, as well as general business operations like payment system integration, human resources, and business intelligence applications. They can also support the management of extra facilities that the establishment provides, like a restaurant, bar, and workout facilities. Many options and features can be added to a PMS system, as seen in Figure 2 below.

As a result, it is simple to implement new functionalities into the PMS system each time, simplifying the work of the employees since more information flows within the hotel and its various departments and there is better communication and organization.

MARKETING AND SALES	
<ul style="list-style-type: none">• Client file• Direct mail• Guest history	<ul style="list-style-type: none">• Travel agent• Meeting room information
NIGHT AUDIT	
<ul style="list-style-type: none">• Room and tax posting	<ul style="list-style-type: none">• Various operational reports
ACCOUNTING	
<ul style="list-style-type: none">• Accounts payable• Accounts receivable• General ledger	<ul style="list-style-type: none">• Payroll• Profit-and-loss statement• Balance sheet
HUMAN RESOURCES MANAGEMENT	
<ul style="list-style-type: none">• Personnel files	<ul style="list-style-type: none">• Time and attendance
ELECTRONIC MAIL	
SECURITY	
RESERVATIONS	
<ul style="list-style-type: none">• Room availability	<ul style="list-style-type: none">• Yield management
FRONT DESK	
<ul style="list-style-type: none">• Check-in• Room status• Postings to guest accounts	<ul style="list-style-type: none">• Guest credit audit• Advance deposits• Cashier
CALL ACCOUNTING	
<ul style="list-style-type: none">• Guest information	<ul style="list-style-type: none">• Phone call posting
HOUSEKEEPING	
<ul style="list-style-type: none">• Room status	

Figure 2 PMS Options [30]

2.3.4 Benefits Of PMS

The use of PMS as a result of technological development has brought many advantages to the hotel industry and hoteliers. These advantages are shown below [11][30][36]:

- Improvements to check-in and check-out procedures
- Data storage in a repository
- Data security
- More effective revenue management
- Increased effectiveness of housekeeping
- Better management of customer data
- Communication between the various departments and employees
- Increased visitor experience
- Enhanced productivity of employees

2.3.5 Cloud–Based Vs Desktop–Based PMS

There is no doubt that with the evolution of hardware, software, and networks our lives have changed significantly. In our daily life, apart from computers, we also use devices such as smartphones and tablets and we are becoming more and more dependent on the internet. Nowadays for any task, we need we move to a digital environment to carry it out. Of course, this is not only the way our everyday life works but also the way the business sector works. An important IT innovation is the cloud, which is essentially the storage of information in a digital environment. The IT textbook drawings that represented distant environments (the Internet) as cloud images in order to hide the complexity that lay behind them are most likely where the term "cloud" came from [35]. The cloud is crucial for Property Management Systems, and the hotel industry will undoubtedly benefit much from this innovation. The following are some benefits of PMS cloud applications over PMS desktop applications [11][36]:

- Lower cost
- No need to install extra software on devices
- Accessible from any device with an internet connection
- Instant online support
- No need to connect to a server located within the hotel
- PMS is directly connected to online reservations
- Easier to implement new features
- Higher data security
- No need for extra hardware
- Easier integration with OTAs and channel managers

Considering everything mentioned above, PMS cloud technology is a solid and reliable option for hotels. Although most hotels have moved to cloud technology for PMS, many are still using desktop PMS. So it is up to each hotelier which of the two types of application he will choose for his business. Of course, it makes sense that using cloud technology would make hotels, especially small ones, which are frequently operated by their owners, more profitable because they wouldn't require more equipment or a separate IT staff for maintenance.

2.3.6 Main Modules of PMS

The automatic execution of the everyday tasks of hotel staff is made possible using modules provided by property management systems. These modules enable the hotel's front desk and back office to optimize and automate all of their current duties. The four primary modules—1) Reservation, 2) Room, 3) Guest Account, and 4) General—are examined below [4]:

Reservation Module

The reservation module keeps track of information about the room status, check-in and check-out dates (date and time), room type, meal plans, and as a result, it's the most fundamental component of a PMS. The front desk is always aware of the availability of rooms as well as the status of reservations, such as whether they have been checked in, checked out, canceled, or pending, thanks to this module. Furthermore, the algorithm used to determine the availability of each type of accommodation on the hotel website when guests want to make a reservation requests the reservation module. Last but not least, the reservation module also stores and manages reservations from OTAs linked to the PMS.

Room Module

The room module is responsible for creating a room which includes room number and type. It also provides information about the state of the room which is very useful for housekeeping. It communicates directly with the reservation module for information such as room type and availability and assists the front desk in maintaining reservations. The room module also correlates the data needed for customer details at check-in and check-out.

Guest Account Module

The Guest account module maintains information about the guests' expenses during their stay, such as bar, restaurant, gym, etc. This module keeps track of the amount that each customer has been charged at any point throughout their stay and based on the information it maintains, useful statistical reports are extracted.

General Module

The general module can be used for human resources payments, assignment of tasks as well as evaluate their performance. It is a general-purpose module that could be used to include a variety of functionalities, including energy-efficient systems and the automatic door shutting.

2.4 State Of The Art Implementations

In this sub-section, state-of-the-art Property Management Systems will be reported which were obtained through research on the well-known Google Scholar search engine. More specifically, the basic elements of current Property Management Systems will be mentioned. These Property Management Systems are:

- inroad Property Management System [37]
- Cloudbeds Property Management System [37][39][40]
- OPERA Cloud Property Management [38] [39]
- Preno Hotel Management System [38][40]

It is worth mentioning that the examination of the above systems contributed to the definition of the requirements of the Property Management System of this master thesis since the basic characteristics that a modern Property Management System must meet were identified.

The above Property Management Systems found through research are all cloud-based and offer several features. In addition to the common features such as check-in, check out and reservations, most of them allow the interface with third-party applications and well-known travel agents. These systems can be found online and offer a free trial period.

2.4.1 inroad Property Management System

The innRoad is a property management system including hotels, motels, resorts, Bed and Breakfast (B&Bs), lodges, and campgrounds. It offers a cutting-edge user interface (UI) and is totally adaptable to all screen sizes. This cloud-based solution is made to respond to all staff activity in a hotel. This cloud-based solution is made to respond to all staff activity in a hotel. Some of the features it has are check-in/out, automated email sending to customers before arrival and after departure, room cleaning management, automatic production of housekeeping reports, room and sales payment per channel, room forecast, etc. It also provides the interface with well-known travel agents such as Expedia, Booking, Airbnb, etc.

2.4.2 Cloudbeds Property Management System

Cloudbeds is a very popular web-based property management system suitable for small to midsize hotels, holiday rentals, and hostels. It supports mobile devices and has a very modern user interface. It allows individual hotel staff to connect by giving them different access rights depending on their role. Its main feature is the drag-and-drop calendar it has

for transferring, creating, and modifying bookings. It also dynamically modifies the availability depending on the changes as it also allows the modification of overnight prices for their automatic publication in well-known travel agencies such as Booking, Expedia, etc. It also provides an interface with Facebook, the most famous social medium for direct room booking. A booking's creation, modification, cancellation, relocation, or adjustment can also always be seen by the hotel staff. Finally, it generates daily reports either automatically or manually, including financial information.

2.4.3 OPERA Cloud Property Management

OPERA Cloud is a Property Management System created by Oracle Hospitality that provides solutions in the hospitality industry. This PMS is cloud-based and can be accessed from any device. It offers tools for enhancing regular operations in hotels of all sizes and levels of complexity. It offers options for the daily needs of the front desk, housekeeping, and food & beverage services. It allows communication between the various departments thus achieving the immediate delivery of services to customers. It provides a personalized dashboard with all the necessary information such as available rooms, occupied rooms, number of arrivals and departures for each day, number of cleaned and number of rooms in need of cleaning. Furthermore, it provides the creation and management of reservations and interaction with travel agents. This system's ability to keep track of visitors' profiles, which allows it to know their preferences and provide them with specialized services, is another advantageous aspect. Finally, it is significant to note that this system, in contrast to others, enables multiple property administration through a single application.

2.4.4 Preno Hotel Management System

Preno is a hotel management system that aims to contribute to the proper management of the hotel's daily activities. It is based on cloud-based technologies, it is quite easy to use and accessible from devices such as smartphones, laptops, tablets, desktops, etc. It covers a wide range of lodging options, including resorts, hotels, motels, lodges, and vacation rentals as well as resorts. Quick check-in/out, dashboards, deposit management, bank reconciliation, and customized reporting are some of its key features. It enables the creation of customer profiles by maintaining information such as room preferences and other services to provide personalized services with the help of the guest management module. Also, it provides speedy features like bill-to-room and group booking management options. In addition, it provides an invoicing system that contributes to financial transactions while

supporting the integration of other accounting applications such as Xero and MYOB. It also integrates with other third-party online payment tools like Stripe, Wishbox, and Lightspeed POS. The front desk employees can create, edit, and transfer reservations just using drag and drop on its dashboard. It supports both individual and group reservations for a number of rooms. It helps the housekeeping staff to know at all times which rooms need cleaning and offers communication to travel agents such as Expedia, Booking.com, and Agoda. Finally, it enables hotel employees to sell services that will be paid for later and to communicate with customers directly via email.

3 RESERVE_IT System Analysis and Design

The modeling and design of the system are required in advance of the development of the Property Management System (PMS), which is the goal of this master's thesis, in order to visualize its numerous features and the ways in which different users will interact with it. Therefore, a textual analysis of the system requirements for the complete system—which includes the front-end and back-end will be presented in this section, followed by requirement diagrams that correlate to the requirements. Then, the above procedure will then be carried out once more with textual analysis and requirement diagrams relating to the various roles that can be connected to the system. The system's component diagram will then be examined, followed by the presentation and analysis of the use case diagrams and sequence diagrams that are related to the system. Then, the EER diagram will be examined and at the end of the section, the technologies used to develop the application will be presented.

3.1 RESERVE_IT Textual Analysis

The creation of this particular project was divided into the front-end, which is the visible component that the user sees and interacts with, and the back-end, which interacts with the database which maintains all the data required and is responsible for the correct operation of this web application. Both parts of the application are equally important for its proper functioning.

First of all, before the implementation of the Property Management System, its requirements had to be determined, which was accomplished through a review of modern PMS currently available on the market [37-40]. This was crucial for this project because it determined the different elements that a state-of-the-art Property Management System like this should provide. Following the definition of the system requirements, the design and different correlations of the database tables were completed. Of course, the database's design was completed following research into previous works that matched the same implementation topic and background [41]. This was crucial since defining the relationships between a database's tables required a thorough understanding of the functionalities that will be implemented.

The back-end implementation then began after the database architecture was complete. The database table representations were first built as entities - classes. The controllers were then developed, where the API endpoints that would be used were specified to enable

communication between the front-end and back-end. Of course, before building the front-end, the endpoints had to be tested for the smooth functioning of the communication between the two components, so the Postman API Platform was used.

After all of the abovementioned tasks had been finished, the front-end implementation process started. To ensure consistency throughout the design process, some web and mobile prototypes were created with the assistance of FluidUI before the deployment of the various components that make up the user interface (UI) of the application.

It is also important to mention that during the implementation of the project, some changes had to be made which usually concerned the backend and the database tables after additional features were added. This was significantly assisted by the Hibernate Framework, which links relational database tables to the objects produced by the object-oriented Java programming language.

The source code for the master's thesis is open source, and anyone can find it on my GitHub [profile](#) for both the Back-end and the Front-end. Throughout the preparation of my master thesis, I had the support, resources, and facilities required to fulfill it. More specifically, two computers were used to write the code and by using GitHub to always have the most recent version of the code available, I managed to work from wherever I was to complete my master thesis. Initially, the project ran locally, and then it was deployed to an online web server in order to test the application's communication with travel agent applications.

3.2 System Analysis

The goal of this study was to develop a Property Management System (PMS) to enable hotel staff in doing their everyday tasks as efficiently as possible. As a result, modern technologies were used to achieve this work instead of the paper-based strategies that were used in the past to manage processes in hotels. Also offered Web Service Support for the Property Management System's communication with Online Travel Agencies (OTAs) like Booking.com and Expedia.com for the online sale of rooms.

3.2.1 System Requirement Analysis and System Requirement Diagram

An effective system presupposes that a series of requirements must be met in terms of its planning and implementation to achieve the desired result. For this reason, the list of main system specifications is listed below in Table 1. These specifications concern a general framework for meeting requirements.

# Requirement	Requirement Name	Requirement Description
Requirement 1	Back-end development	This system is responsible for managing and responding to requests submitted by the user
Requirement 2	Front-end development	The visual part that the user interacts with
Requirement 3	Database development	The repository that is responsible for storing web application data.
Requirement 4	Communication Endpoints (APIs)	Describes the HTTP requests that users make to interact with the Back-End.
Requirement 5	User Registration	The system allows user registration with a username and password.
Requirement 6	User Authentication	For granting access, the system has to make sure that credentials including username and password are accurate.
Requirement 7	Security	In addition to the simple check for user authentication, it is necessary to add an extra security layer such as JWT Authentication which certifies that only authorized users will have access to the corresponding content.
Requirement 8	User Roles	<p>The following users are permitted access to the system:</p> <ul style="list-style-type: none"> ▪ ADMIN ▪ HOUSEKEEPING STAFF ▪ BAR & RESTAURANT STAFF <p>It should be noted that the structure is set up in such a way that changing, adding, and removing roles in the future is simple.</p>
Requirement 9	Responsiveness	The application is fully responsive on all device screen sizes.

Requirement 10	Customized Web Service Support	A communication protocol is provided to communicate with channel managers and OTAs.
Requirement 11	Objected-oriented principles (OOP)	Implementation includes OOP concepts such as abstraction, encapsulation, polymorphism, and inheritance.
Requirement 12	Deployment	To access the web application from all types of devices, its deployment on a web server is essential.

Table 1 System Requirement List

The three requirements—Back-end development, front-end development, and database development—are the key components that contribute to the creation of this web application. Therefore, in Figure 3 presented below can be observed the system requirements diagram which was created with the help of Visual Paradigm and composes the functionality of the RESERVE_IT web application.

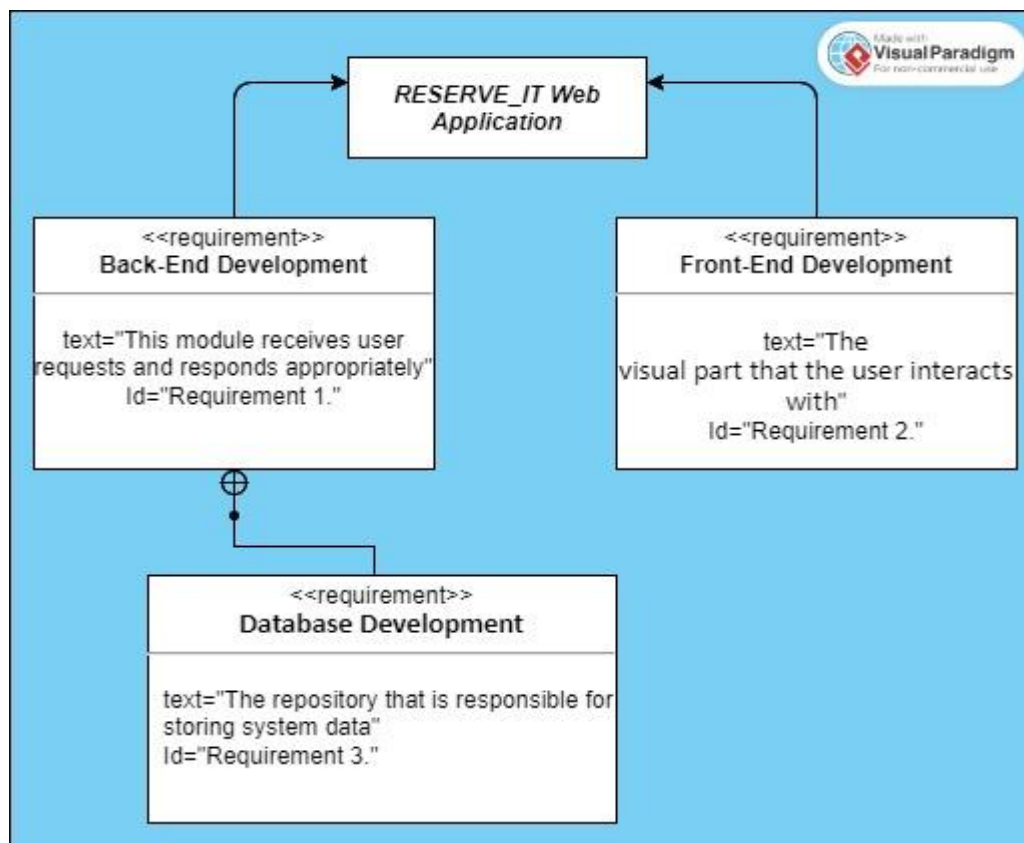

Figure 3 System Requirement Diagram

As can be seen in Figure 3, the application consists of the Front-End which is the visual part that the user will see, the database which is responsible for maintaining data and is in

exclusive and continuous communication with the Back-End which executes the requests it accepts from the user and responds appropriately to the Front-End.

3.2.2 Backend Requirement Diagram

As shown in Figure 4 below, the Back-End requires user registration to use the application, and then user authentication, which relies on the JSON Web Token (JWT) as a security layer that certifies by producing a digital signature that a user is authorized to use the application, and API endpoints that are constantly in contact with the database. This ensures that the Back-End can manage and respond to each user's requests at all times.

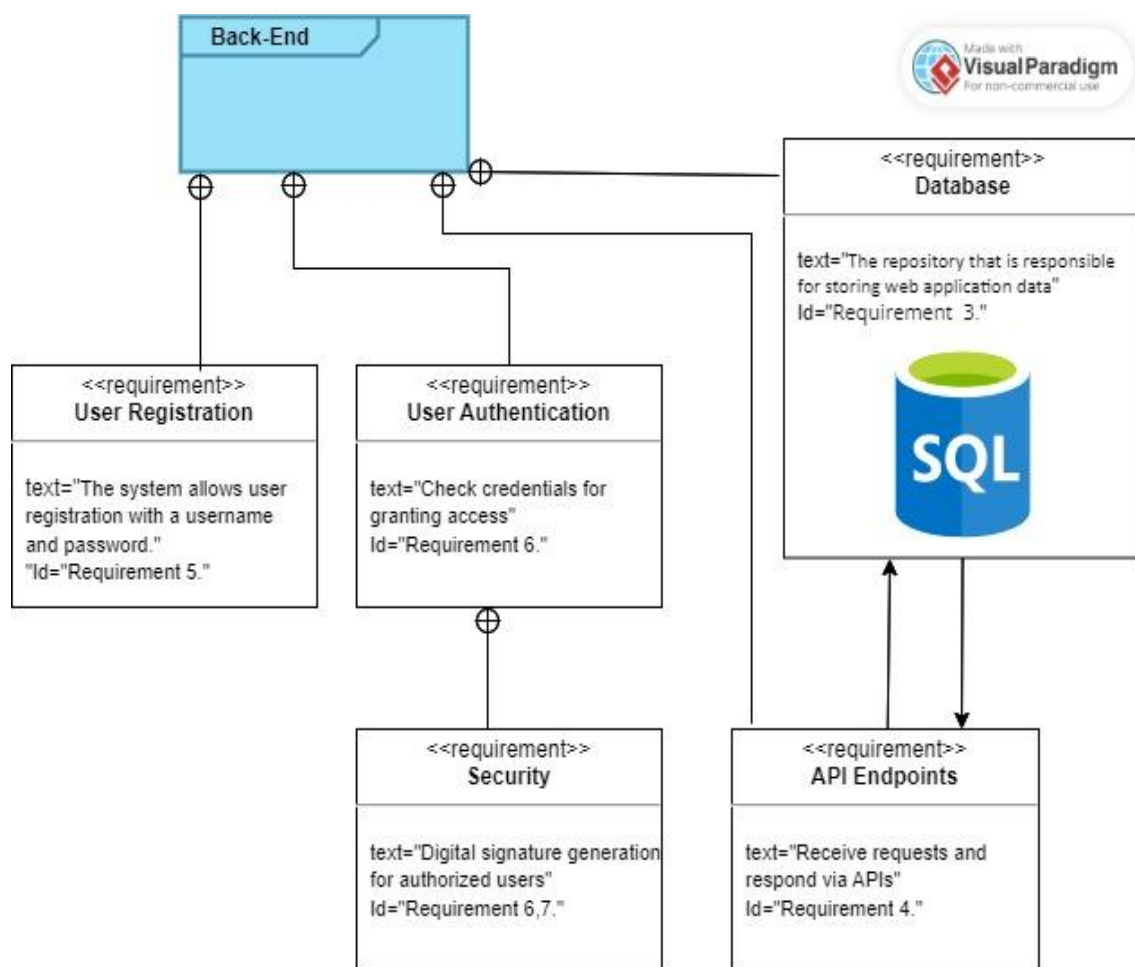

Figure 4 Backend Requirement Diagram

3.2.3 Frontend Requirement Diagram

Below in figure 5 can be seen the requirement diagram concerning the frontend part of the user interface. More precisely, styling using technologies such as CSS, Bootstrap, and Angular Material, responsiveness for accessing the application from devices with different screen sizes, as well as the configuration of content depending on the role of the connected

user, are significant aspects of the front-end. The various visual components that compose the application and enable user interaction can also be observed.

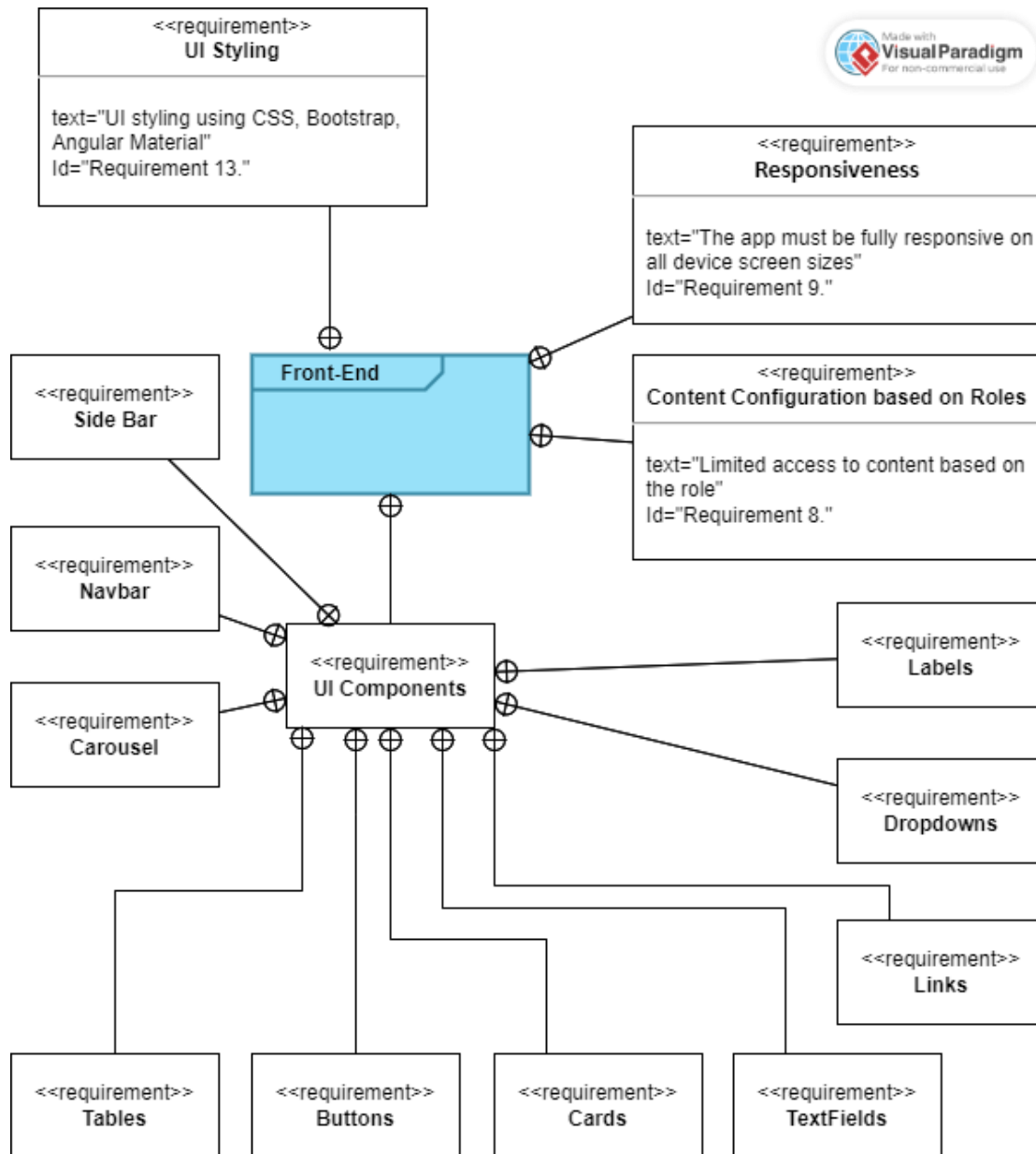

Figure 5 Frontend Requirement Diagram

3.2.4 Database Requirement Diagram

It's important to determine the requirements of the database, which is a crucial component of the system, in addition to those already mentioned above regarding the front-end and back-end components. As can be seen JPA (Java Persistence API) is used to create tables and configure relationships between them and Hibernate which is a JPA implementation to store Java objects in relational database tables.

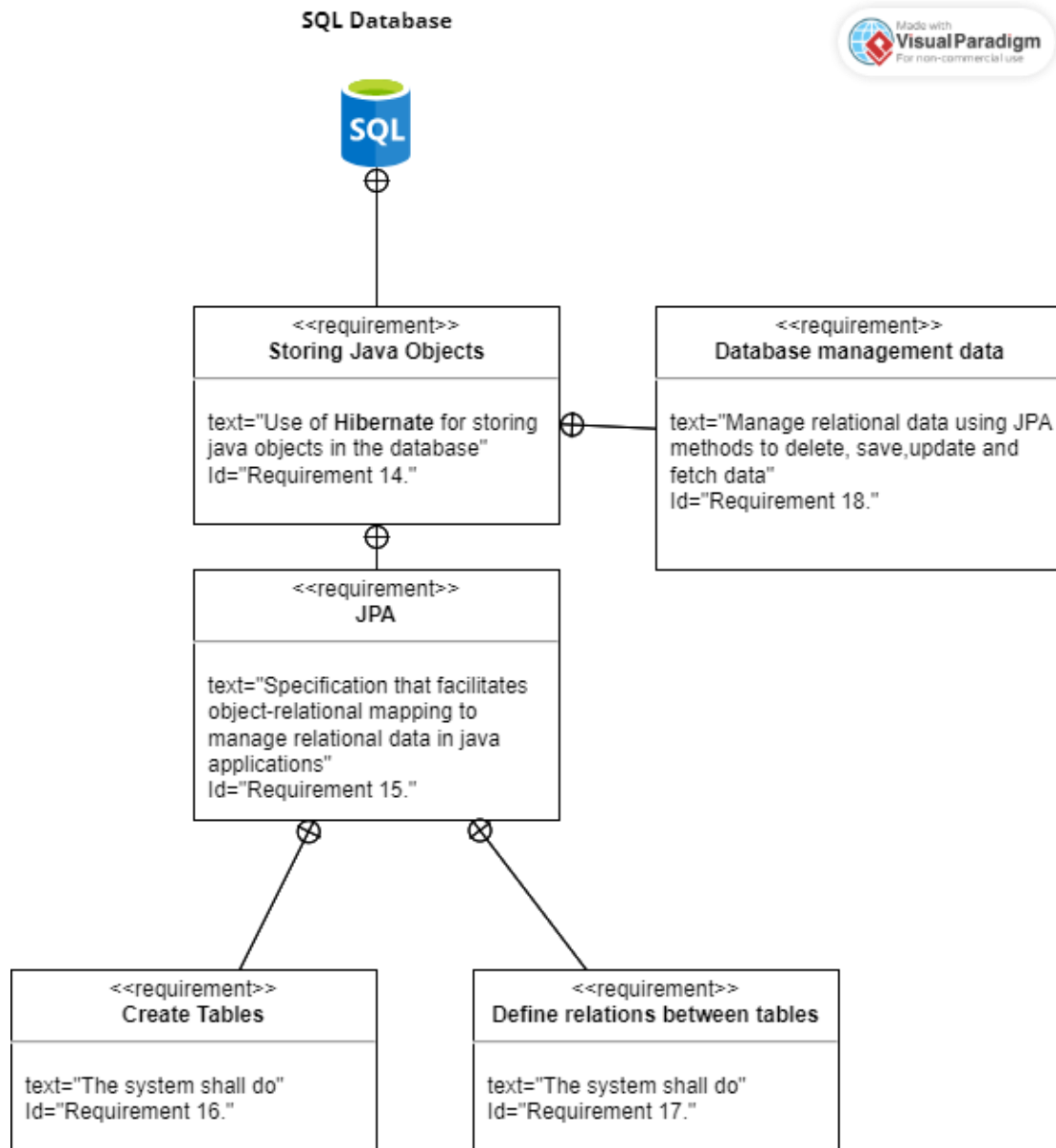

Figure 6 Database Requirement Diagram

3.2.5 Role Requirement Analysis and Requirement Diagrams

In order to create and implement an effective system that yields the desired goal, a number of conditions must be satisfied. More specifically, the system should provide specific features and capabilities to the different user roles that use it, customizing the content of the application appropriately for each one. Therefore, the requirements that the program must satisfy for each different user role are listed in Table 2 below. The application supports the connection of three distinct user roles, giving them different permissions. The following user roles are authorized by the application:

- Admin

- Housekeeping Staff
- Bar / Restaurant Staff

As can be seen, only the Admin role has access to all of the application's features and content, while the roles of Housekeeping Staff and Bar/Restaurant Staff only have access to a limited part of that content, which naturally relates to the specifications that were established during the system's design.

Role	Actions - Requirements
<p>Admin</p>	<ul style="list-style-type: none"> ▪ Hotel Specifics Module: Hotel information management ▪ Room Module: Room administration ▪ Room Type Module: Room type administration ▪ Availability Module <ul style="list-style-type: none"> ○ Availability By Room Number: Dynamic availability table by room number with date adjustment ○ Availability By Room Type: Dynamic availability table by room type with date adjustment ▪ Reservation System Module: Administration of individual and composite reservations ▪ Check In / Check Out Module <ul style="list-style-type: none"> ○ Check In Operations ○ Check Out Operations ▪ Customer Module: Search customers by full name and management ▪ Tour Operator Operations Module

	<ul style="list-style-type: none"> ○ Tour Operators: Management of tour operators. ○ Check Out Tour Operators: Tour operators' payment system that also includes a credit subsystem. ○ Tour Contracts: Administration of tour operator contracts ▪ Housekeeping Module: Room cleaning management ▪ Statistics Module: View statistics such as revenue and visitors using charts based on the selected month and year
Housekeeping Staff	<ul style="list-style-type: none"> ▪ Housekeeping Module: Room cleaning management ▪ Room Module: Privileges only to view & modify room status (Cleaned, Dirty, Needs Inspection).
Bar / Restaurant Staff	<ul style="list-style-type: none"> ▪ Room Module: Access only to extra charge hotel services based on room number and current customer.

Table 2 System Requirement List Based On Different System Roles

3.2.6 Admin Requirement Diagram

The logged-in user with Admin rights, as seen in Figure 7, has access to system features like room management, reservations, availability by room number or type, check-in/out, invoicing, contract creation, tour operator management, hotel customer management, housekeeping, hotel information management, and view statistics using charts. It is important to note that all CRUD functions, including creation, reading, deletion, and updating, have been implemented for all the necessary modules.

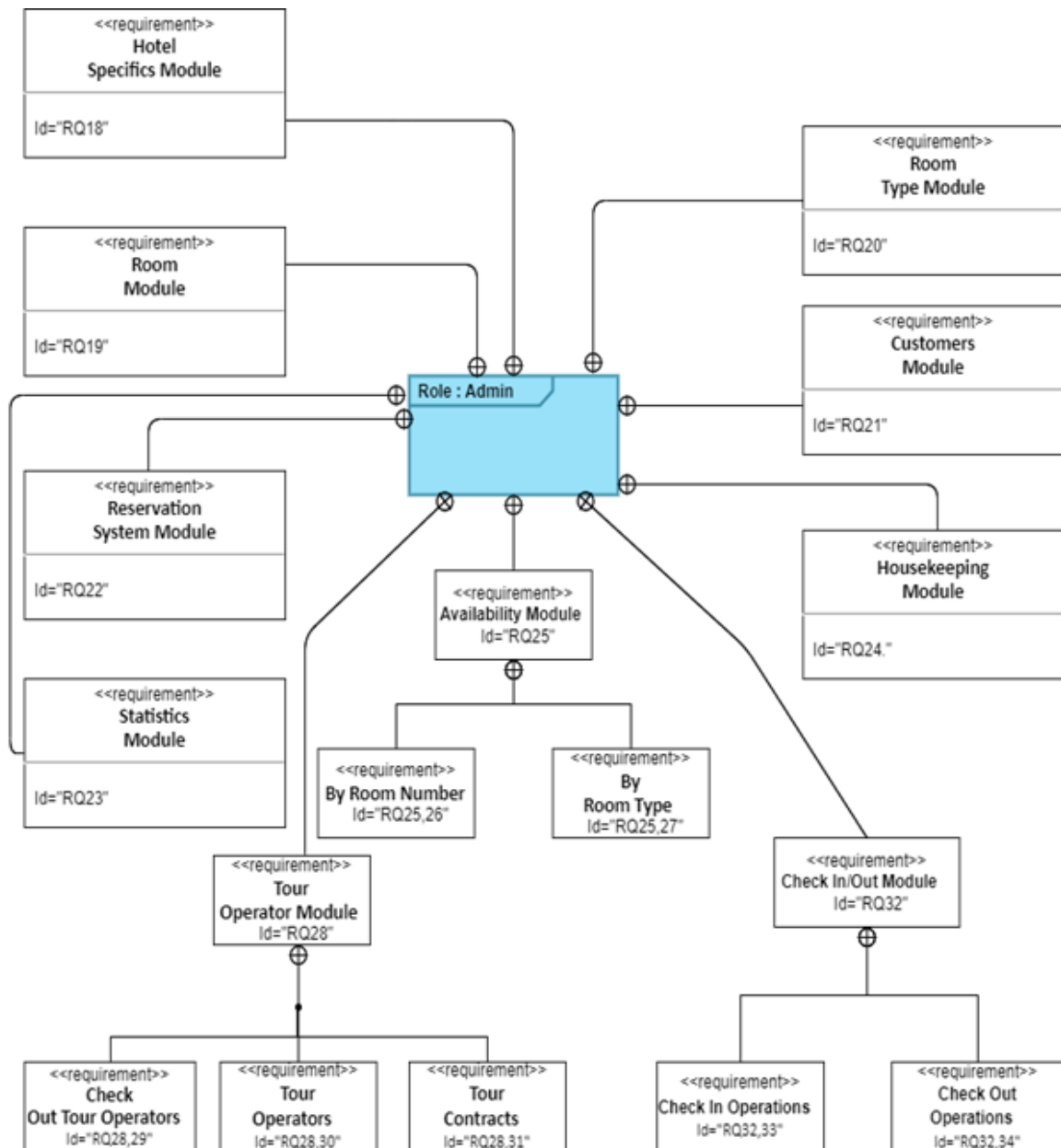

Figure 7 Admin Requirement Diagram

3.2.7 Housekeeping Staff Requirement Diagram

The requirements for authorized users with Housekeeping Staff privileges are shown in Figure 8 below. More specifically, access to 2 application modules is permitted for these connected users. The first is the Room Module, where the user can update the status of the room. The second is the Housekeeping Module, which provides a list of the rooms that need cleaning or inspection and the option to change the status of the room to "cleaned" after cleaning or inspection.

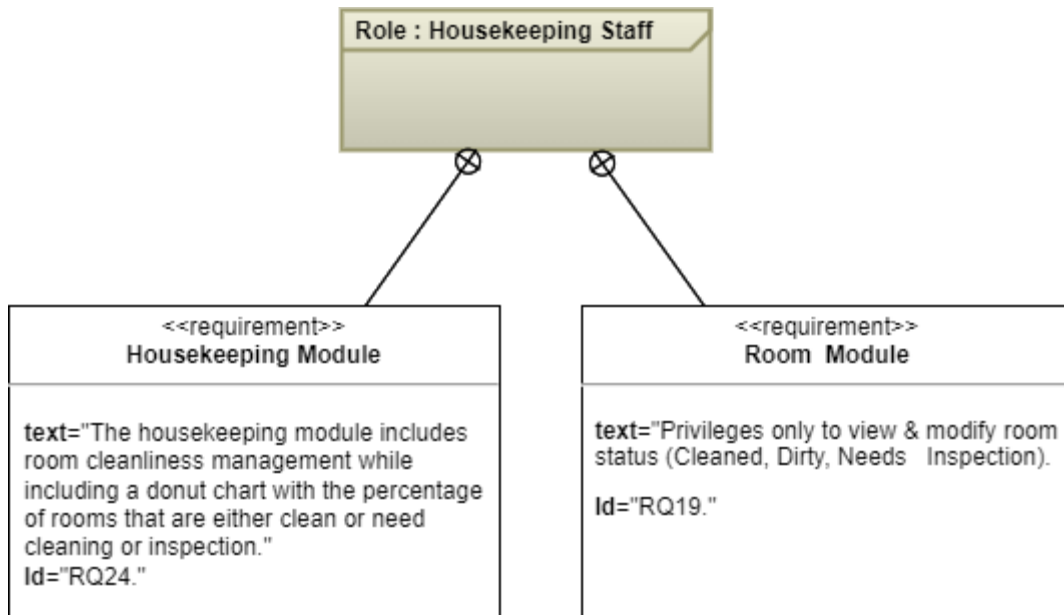

Figure 8 Housekeeping Staff Requirement Diagram

3.2.8 Bar / Restaurant Staff Requirement Diagram

As seen in Figure 9 below, users with bar/restaurant staff permissions have access to the room module, from which they can bill additional services for individual rooms and customers.

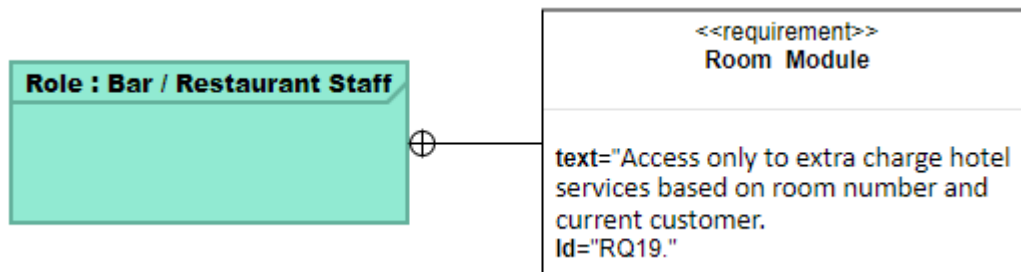

Figure 9 Bar / Restaurant Staff Requirement Diagram

3.3 RESERVE_IT System Design

Software engineering uses the Unified Modeling Language (UML) as a standard to represent design models. UML diagrams assist in defining system requirements, representing them through the use of visual models, and determining their scope [42]. A system's functions can be better understood by representing various user scenarios using UML as a visual language. UML is divided into two categories: 1) Structural Diagrams, which include class, object, and component diagrams, etc., and 2) Behavior Diagrams, which include use case diagrams and sequence diagrams, etc [43]. Although there are many

different diagrams, the ones to choose depend on how the system will be represented and modeled. The UML diagrams that will be examined in this section are the following:

- Component Diagram
- Use Case Diagram
- Sequence Diagram

3.3.1 System Component Diagram

System modeling using component diagrams depicts how multiple software components are connected to develop enhanced software systems [42][43]. Component diagrams give software engineers a clearer idea of how the various system components work together to build an integrated system.

Therefore, Figure 10 depicts the connection of the different parts of the application which are the Back-End, the Front-End, and the Database.

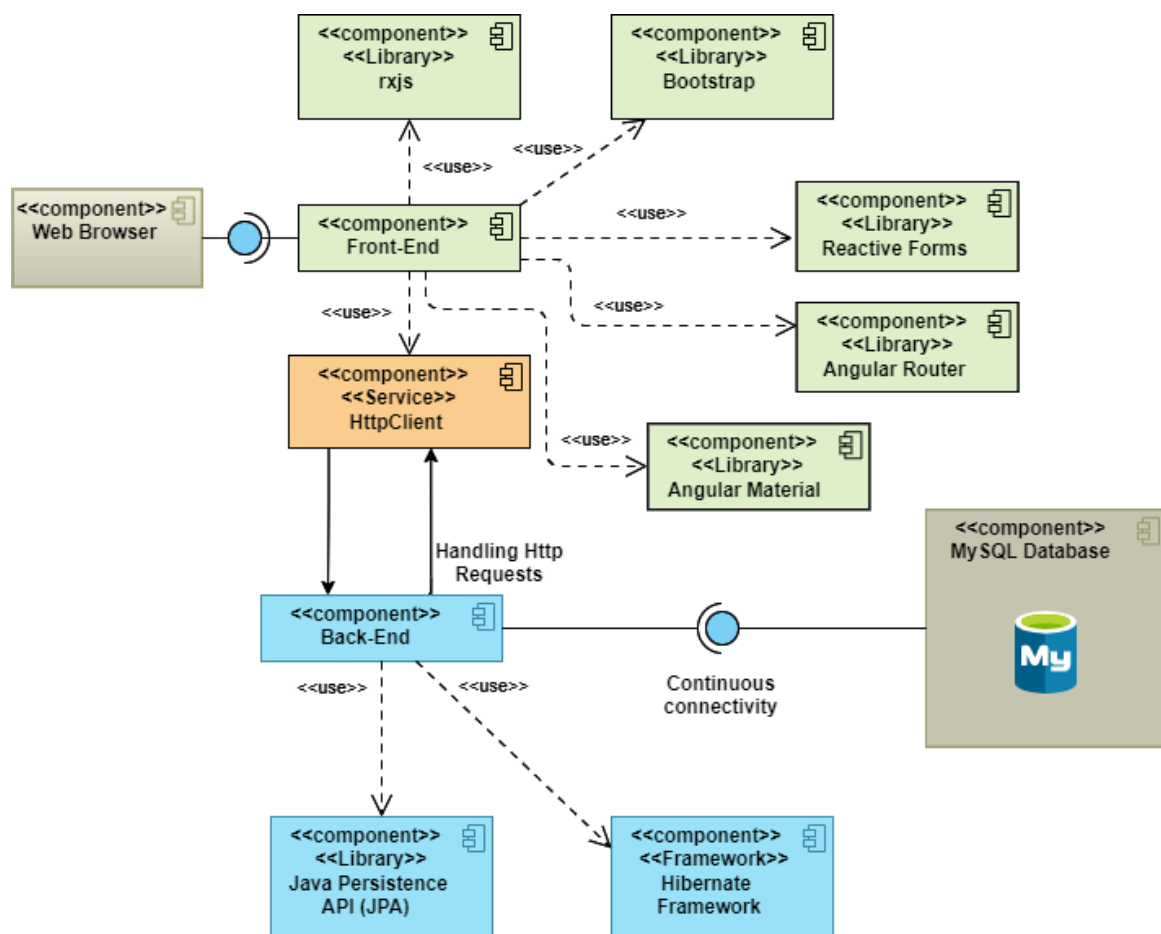

Figure 10 System Component Diagram

More specifically, the Back-End communicates with the database and uses Hibernate to connect Java objects to its tables and JPA to create relationships between tables. The Front-End uses a variety of libraries for visual representation and communicates with the Back-End using the HttpClient service offered by Angular's HTTP API while the web application can be accessed through a Web Browser.

3.3.2 Use Case Diagram

Use Case Diagrams are used to show various scenarios of interactions between different users and system functionalities [42][43].

As shown in Figure 11 below, all users must successfully register and authenticate to the system before using the application. The logged-in users with Admin privileges have access to all system features like room management, reservations, availability by room number or type, check-in/out, invoicing, contract creation, tour operator management, hotel customer management, housekeeping, hotel information management, and view statistics such as revenue and visitors per month and year using bar charts. All required CRUD operations are carried out as part of the features mentioned above. The logged-in users with Housekeeping Staff privileges have access to housekeeping administration and finally, logged-in users with Bar / Restaurant privileges have access to charging additional services within the hotel.

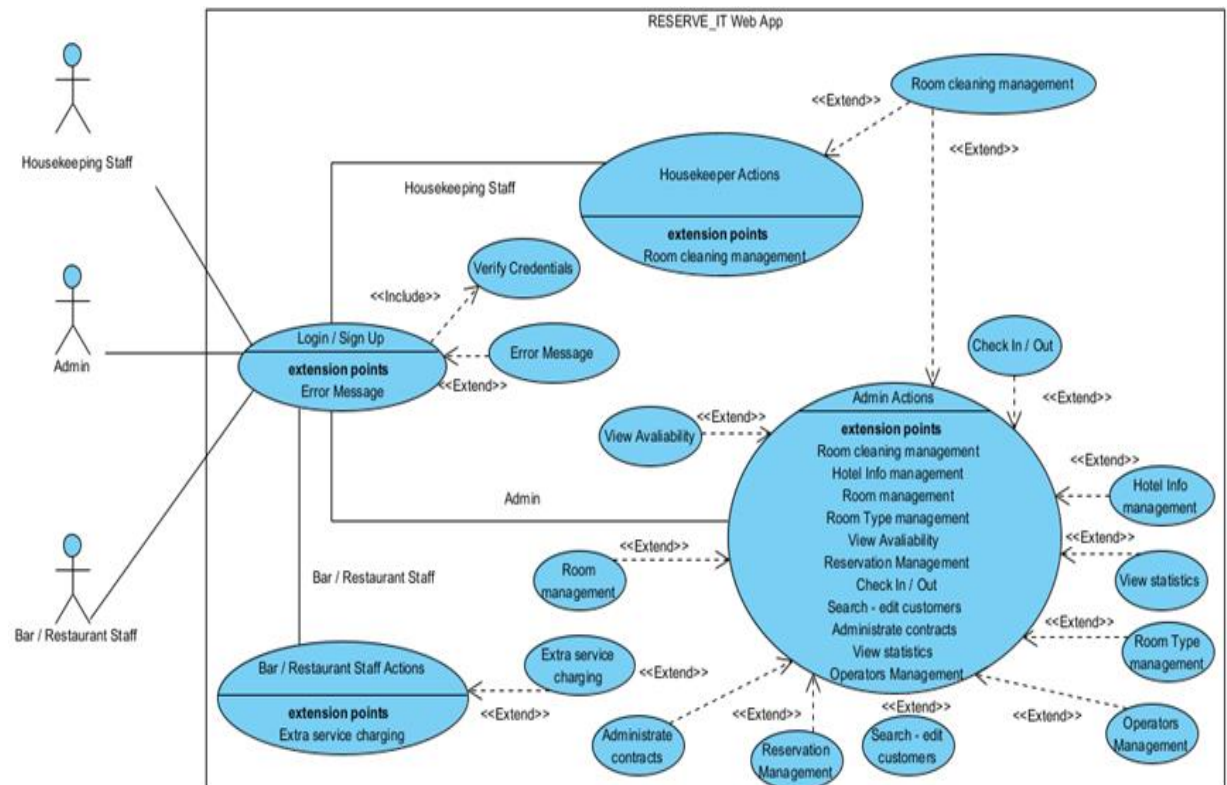

Figure 11 System Use Case Diagram

3.3.3 Sequence Diagrams

Sequence diagrams are frequently used by software developers to visualize the interactions between processes that are run in a system in a particular order. These diagrams conceal the messages exchanged between the processes that are required for a use case scenario's proper execution and highlight the events produced by the system's external factors (users) [42][43].

Two sequence diagrams have been made for users with administrator privileges to simplify the scenarios, which are shown below. As shown in Figure 12, the Admin logs in to the application and chooses to access the Hotel Management Module, where he creates or modifies the hotel's basic information. After that, he selects the Room Type Module, where he manages room types, and finally the Room Module, where he creates rooms and maps them to room types.

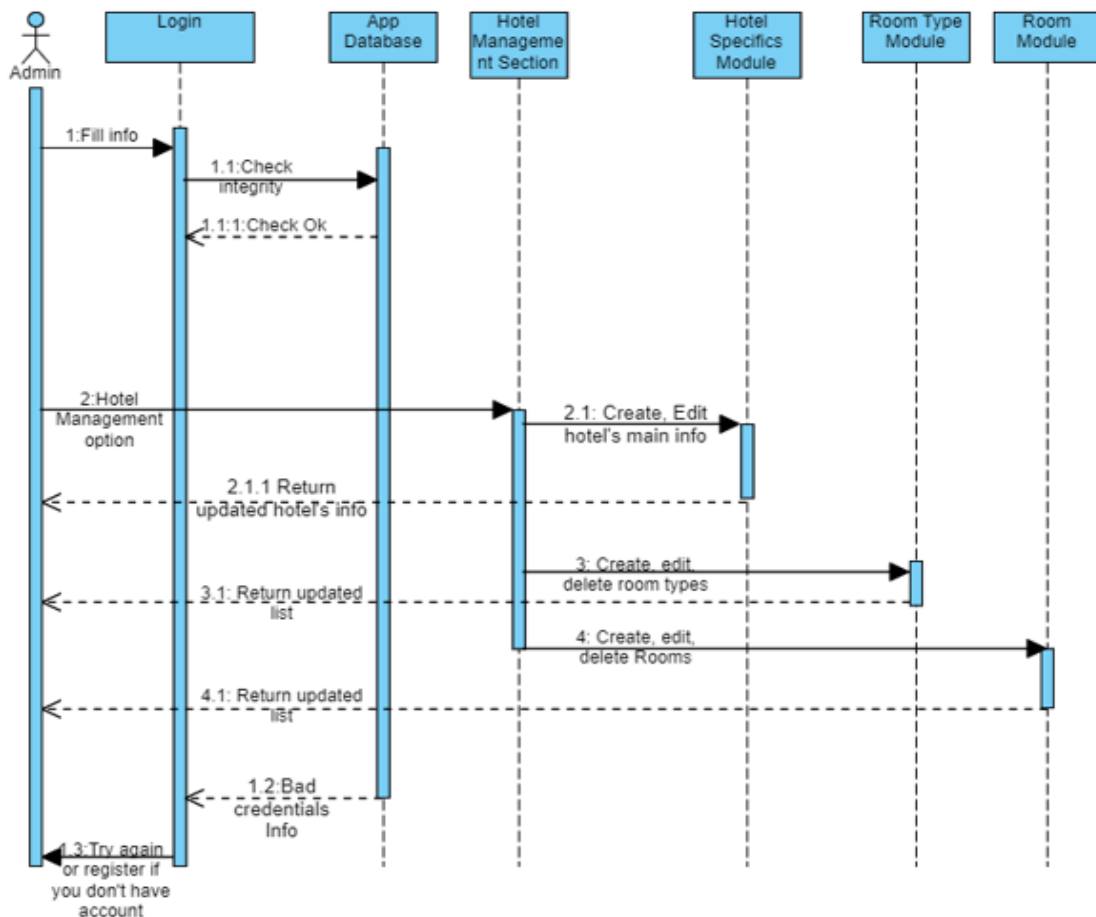

Figure 12 Admin Sequence Diagram (a)

The scenario that covers the remaining PMS features is shown in Figure 13 below. To make the structure simpler, we'll assume that the user has already logged into the system. After choosing the Tour Operators Section, the user can either access the Tour Operators

Module, which allows him to manage Tour Operators, or the Tour Contracts Module, where he can create and manage tour contracts. Then, by accessing the Reservation Module, he makes reservations for both direct hotel guests and those booked through a tour operator. Afterward, when guests arrive at the hotel, they need to be checked in and assigned rooms. The administrator performs this task through the Check In / Out Module, where he can also check out on the day of departure and provide each guest with the necessary receipts. After that, the admin selects the Check Out Operators Module, which also contains a credit system, in order to handle tour operators' check-out. In addition, the admin selects the Availability Module to check availability by room type or number. Afterward, he is checking some statistics like revenue and visitation by month and year in Statistics Module, and finally, he monitors housekeeping from Housekeeping Module.

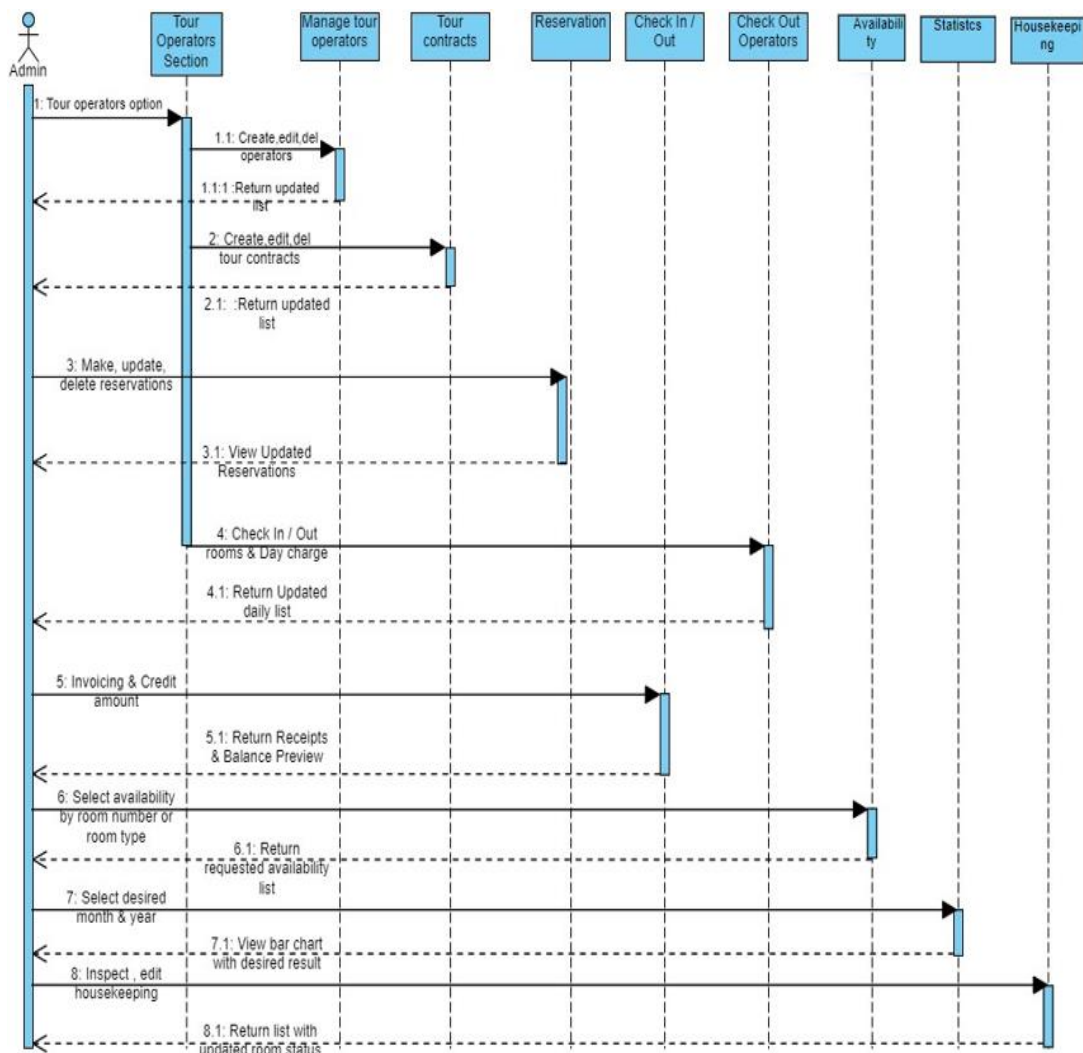

Figure 13 Admin Sequence Diagram (b)

The following Figure 14 depicts a Housekeeping Staff user logging into the system. By choosing the Housekeeping Module, he manages the hotel's housekeeping by viewing the

rooms that need to be cleaned or checked and finally the user selects the rooms that have been cleaned or inspected.

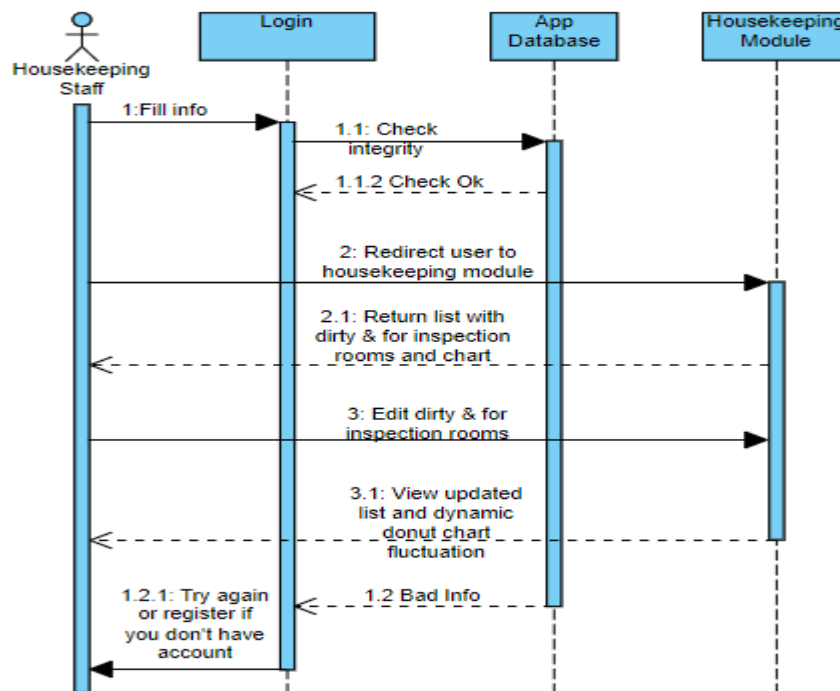

Figure 14 Housekeeping Staff Sequence Diagram

In the following Figure 15, a user with Bar / Restaurant Staff privileges can be seen logging in to the system. Next, after choosing the Room Module, he charges extra hotel services based on the room number and the client's name.

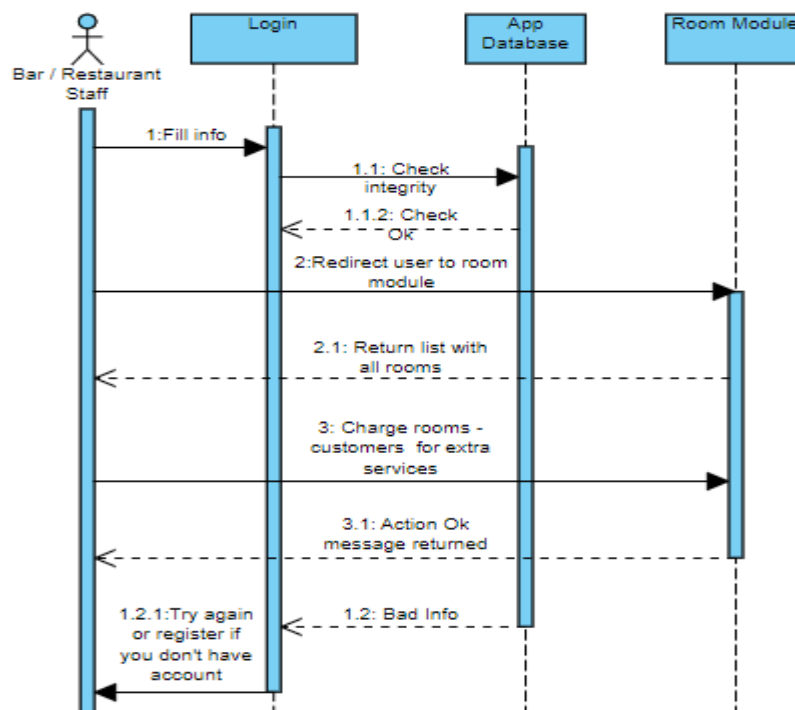

Figure 15 Bar / Restaurant Staff Sequence Diagram

3.4 Extended Entity Relationship Diagram (EER)

The Extended Entity Relationship Diagram, or EER Diagram, provides ER's features but in greater detail. Describes relationships between entities and is used as a representation of the database before its creation [44].

Figure 16 below represents the relationships between the entities of the relational database of this work. As can be observed, entities that are most correlated with others are reservation, reservation type, room, room type, and tour operator.

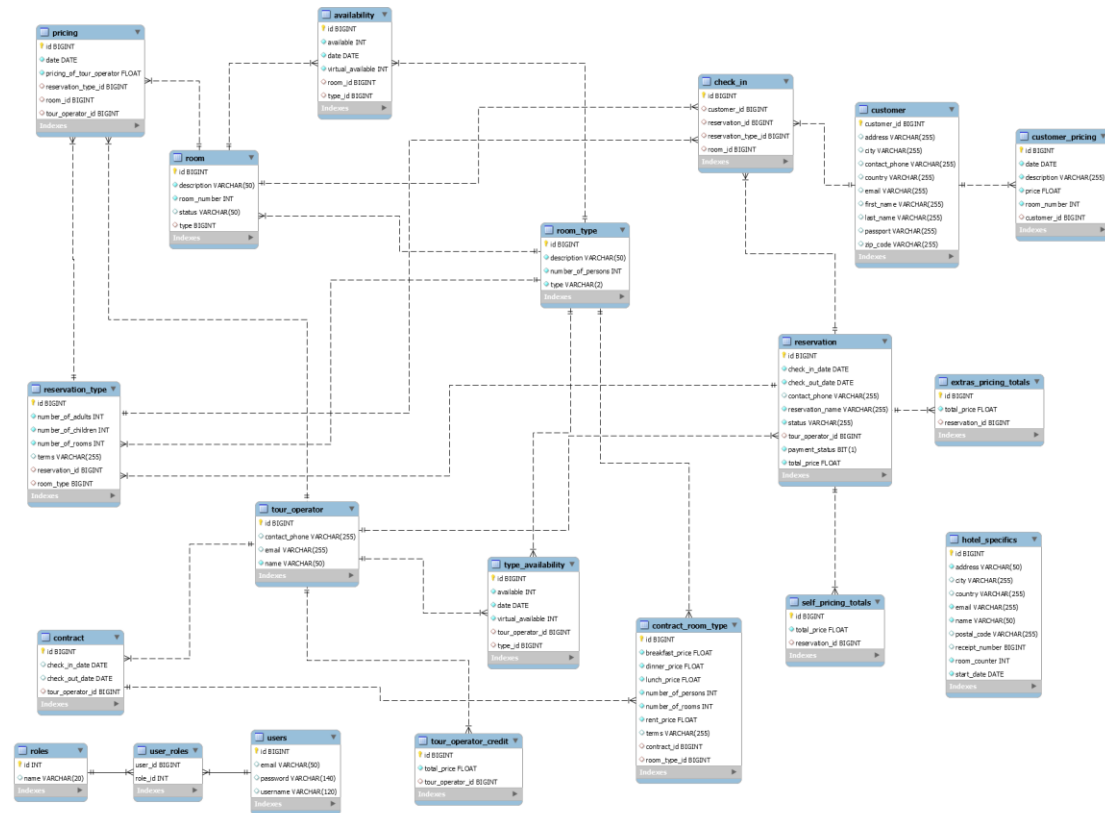

Figure 16 EER Diagram

3.5 Technologies used to develop RESERVE_IT

This master's thesis was a motivation for me since I had to deal with full-stack development. Tying together the technologies used in both the Back-end and Front-end was a challenge. It is important to mention here that the selection of state-of-the-art technologies used for the implementation of this work resulted after research was conducted. More specifically, the technologies used are:

- **AngularJs** for the Front-End development of the application
- **Spring boot** for the Back-End development of the application and database connection

- **MySQL was** used in this work for storing, maintaining, and accessing data

3.5.1 AngularJS

AngularJS is an open-source web application framework based on JavaScript and is offered to the public by Google [45]. It is one of the most well-known frameworks and aims to develop web apps. It offers a stable code structure to the developer, a strong community, and generally an API with which anyone can easily develop an application. It uses TypeScript as a programming language and its architecture is based on the Model-view-controller software pattern (MVC). Angular uses the npm tool provided by Node.js to download libraries and packages. Below are the main libraries and services used for this work:

- **RxJs:** using observables makes it simpler to build asynchronous code for reactive programming apps.
- **Ng-bootstrap & Angular Material UI:** They are provided by Angular, are open source, and provide modern UI components and classes for building a beautiful application.
- **Angular Router:** By interpreting the URLs that have been set as a view change, it is utilized to navigate the user through the application.
- **HttpClient Service:** It achieves the communication between the Front-End and the Back-End.

3.5.2 Spring Boot

Spring boot is an enhanced extension of the Spring framework and is used to build stand-alone and production-ready spring applications with the Java programming language. The most significant development is auto-configuration, which has significantly decreased the number of parameters that previously needed to be defined using XML or Java [46]. The following dependencies were required in order to build the application's Back-End:

- spring-boot-starter-data-jpa
- spring-boot-starter-web
- spring-boot-starter-data-rest
- mysql-connector-java
- lombok
- spring-boot-starter-security
- jjwt

3.5.3 MySQL Database

MySQL is a relational database management system created and provided to the general public by Oracle Corporation. Although there are many database management systems, MySQL is the most popular. In more detail, MySQL enables the creation of tables, the definition of relationships between them, and the storage, retrieval, modification, and deletion of data [47]. Figure 17 shows how the Backend is connected to MySQL and how the Hibernate Framework is used to automatically update the Java-created tables in the database.

```
#MySQL Connection
spring.datasource.url= jdbc:mysql://localhost:3306/hotel_database
spring.datasource.username= username
spring.datasource.password= password

#Hibernate auto update
spring.jpa.properties.hibernate.dialect= org.hibernate.dialect.MySQL5InnoDBDialect
spring.jpa.hibernate.ddl-auto= update
```

Figure 17 Database Connection & Hibernate

4 Pilot Implementation

After the completion of the previous unit where the system was designed and analyzed, we will examine and analyze the features and functionalities of the application. More specifically, the corresponding pilot implementation for each use case scenario will be examined. Below, the following use case scenarios will be examined:

- Admin use case scenario
- Housekeeping Staff use case scenario
- Bar / Restaurant Staff use case scenario

4.1 RESERVE_IT Home Page

Everyone who accesses the application will first see its home page, which has a navigation bar from which anyone can sign up or log in. A carousel of images can also be seen on the application's home page, and a footer with various details can be found at the bottom of the page. Figure 18 below represents the home page of the RESERVE_IT web application.

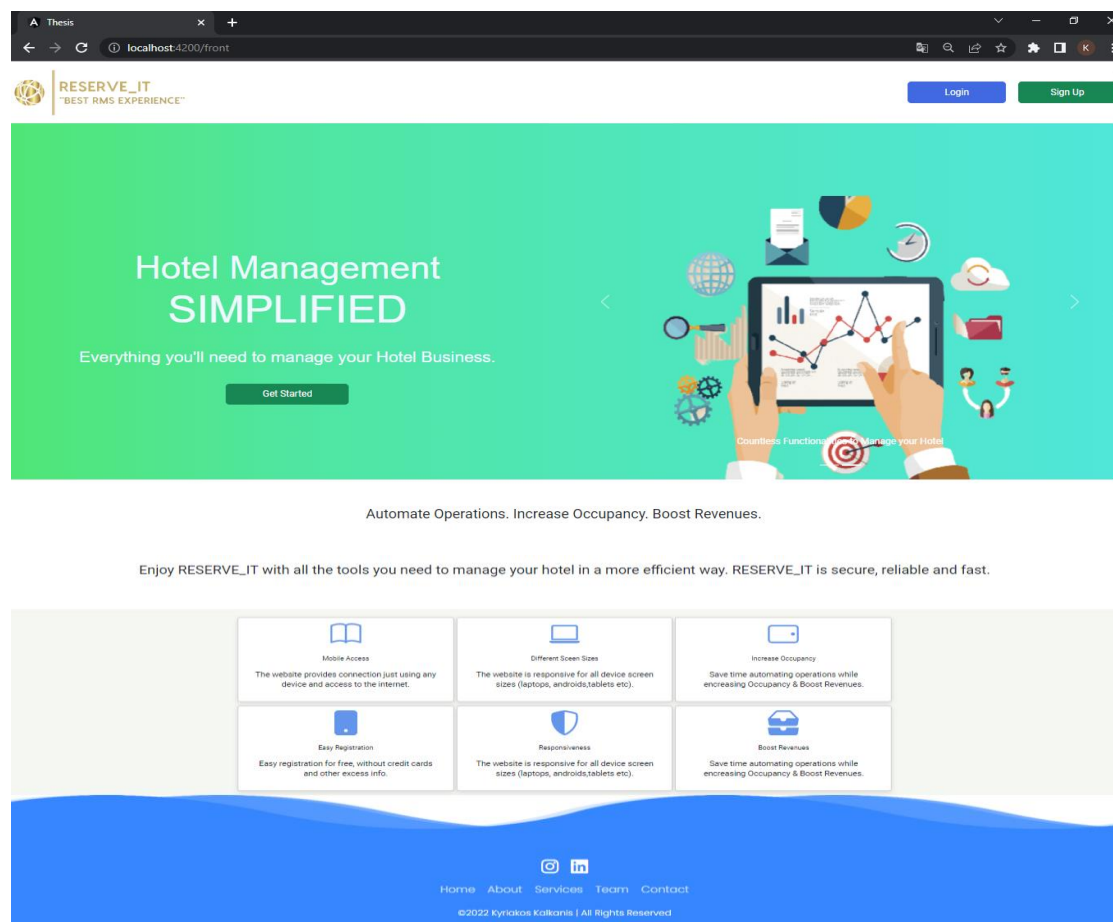

Figure 18 Home Page

4.2 Sign Up – Login Forms

Everyone who wants to use the app must first register, as indicated in Figure 19. The required information is the role, username, and password. It should be mentioned here that all the fields of all the forms of the application contain validation. The application redirects the user to the login form after the connection is made successfully which is shown in Figure 20 and requires a username and password to provide authorization.

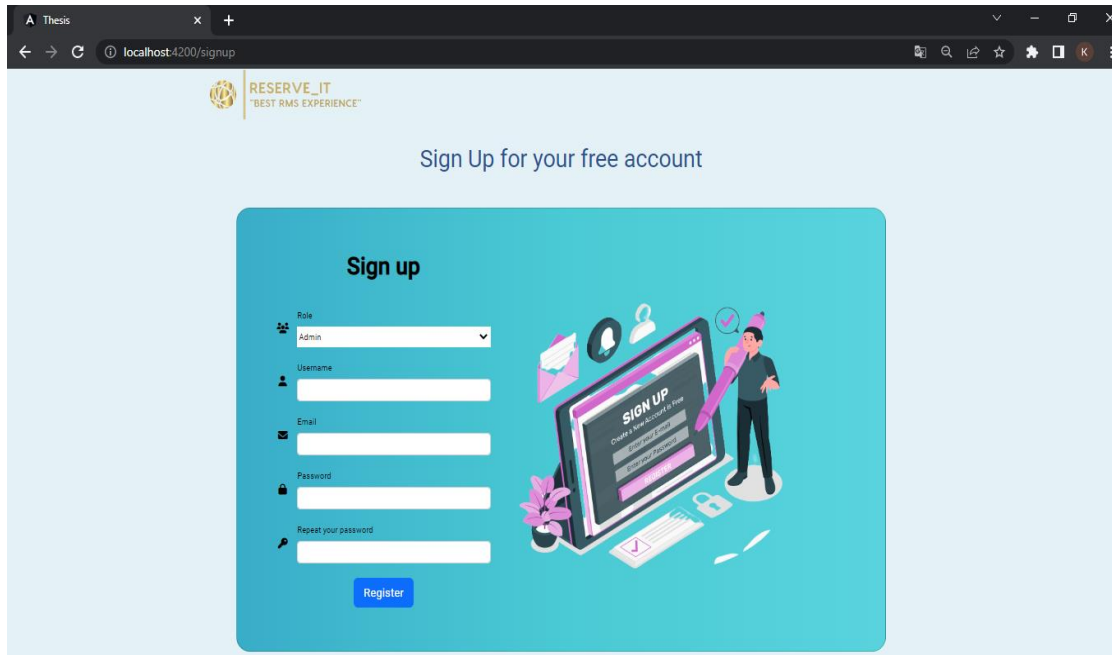

Figure 19 Sign-Up Form

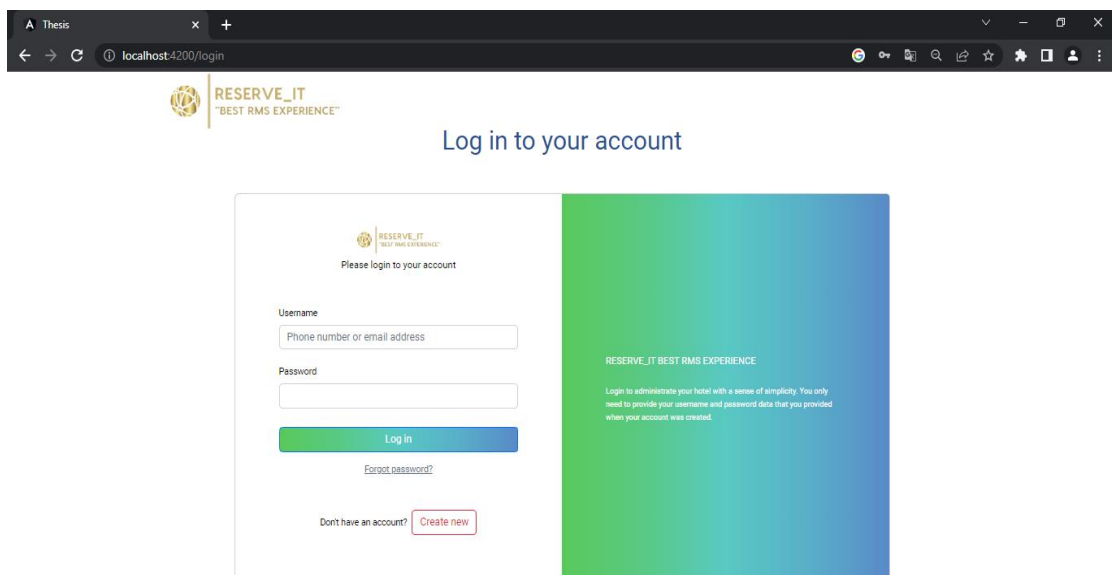
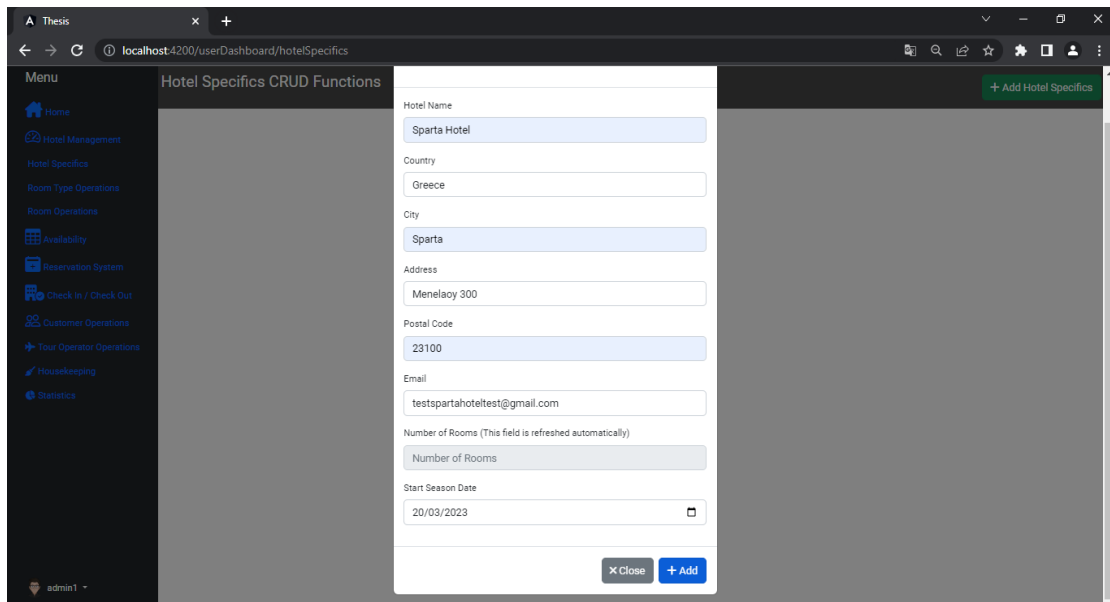

Figure 20 Log-In Form

4.3 Admin Use Case Scenario

4.3.1 Hotel Specifics Module

When a user with admin privileges first logs in, he is redirected to the Hotel Specifics Module to enter the application's fundamental fields, including the hotel's name, full address (country, city, address, and postal code), email, and start season date shown in Figure 21. After the admin fills out the form and clicks the Add button, the data is saved, and he may later edit it if needed as can be seen in Figure 22.



The screenshot shows a web browser window with the URL localhost:4200/userDashboard/hotelSpecifics. The page title is 'Hotel Specifics CRUD Functions'. On the left is a dark sidebar menu with options: Home, Hotel Management, Hotel Specifics, Room Type Operations, Room Operations, Availability, Reservation System, Check in / Check Out, Customer Operations, Tour Operator Operations, Housekeeping, and Statistics. The main content area contains a form for adding a new hotel. The form fields are: Hotel Name (Sparta Hotel), Country (Greece), City (Sparta), Address (Menelaos 300), Postal Code (23100), Email (testspartahoteltest@gmail.com), Number of Rooms (Number of Rooms), and Start Season Date (20/03/2023). There are 'Close' and '+ Add' buttons at the bottom right of the form.

Figure 21 Hotel Specifics Module (Add Hotel Specifics)

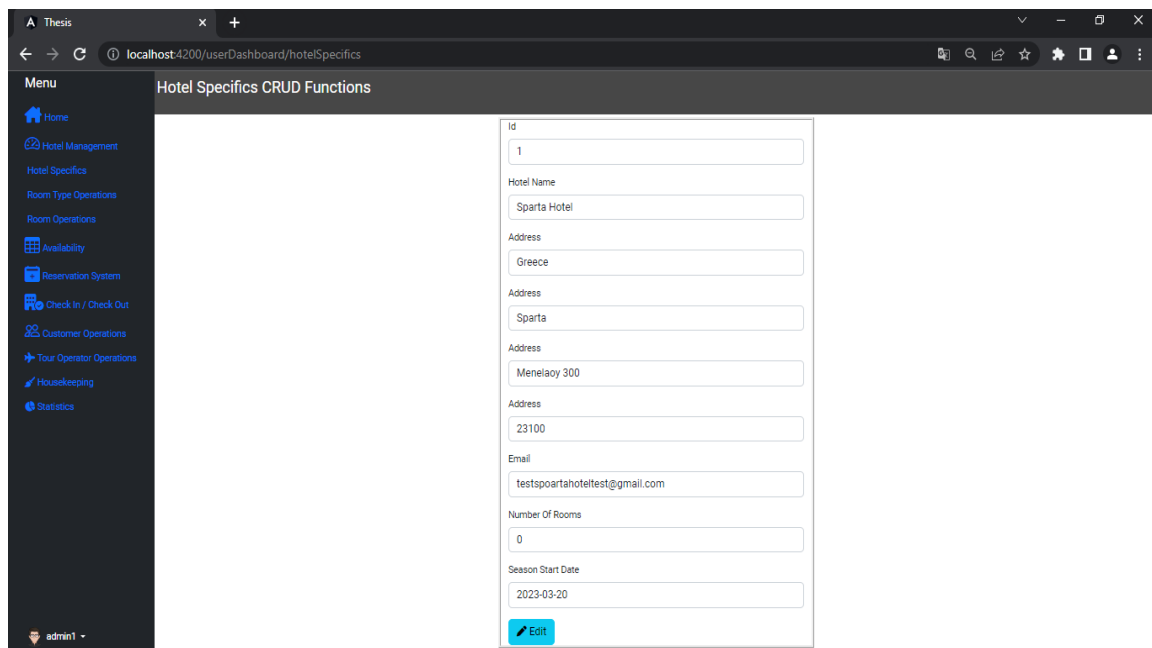

The screenshot shows the same web browser window, but now displaying the 'Edit Hotel Specifics' form. The form is pre-filled with the data from Figure 21. The fields are: Id (1), Hotel Name (Sparta Hotel), Address (Greece), Address (Sparta), Address (Menelaos 300), Address (23100), Email (testspartahoteltest@gmail.com), Number Of Rooms (0), and Season Start Date (2023-03-20). There is an 'Edit' button at the bottom right of the form.

Figure 22 Edit Hotel Specifics

If the user wants to make the changes to the database permanent, he updates his data and presses the Update button as shown in Figure 23.

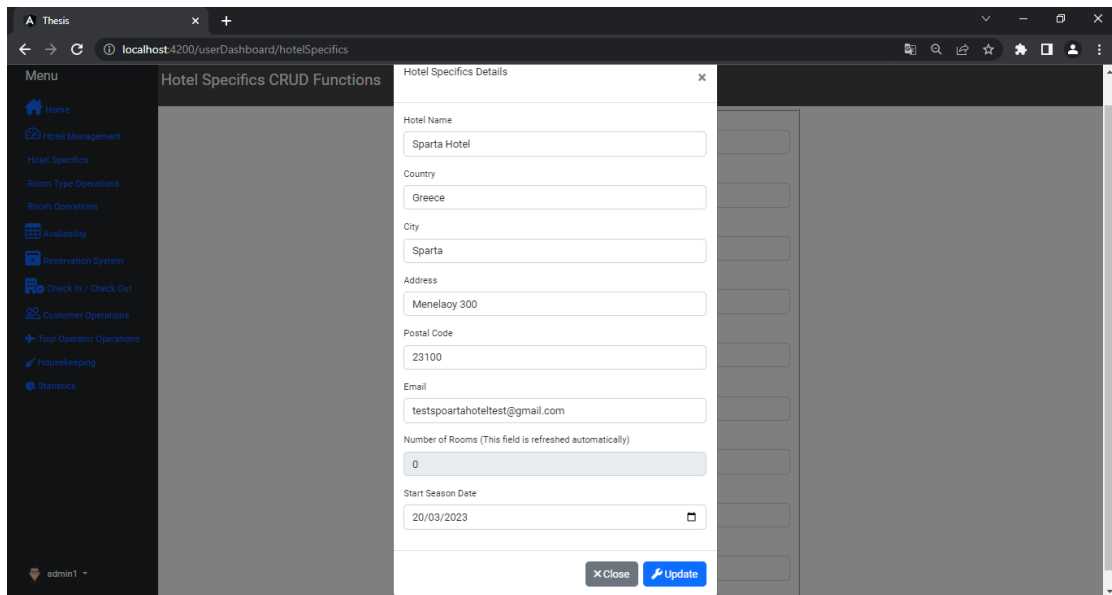

Figure 23 Update Hotel Specifics

4.3.2 Room Type Module

By selecting Room Type Operations from the sidebar and then clicking the Add Room Type button, the user can then add new room types filling in the room type, number of persons, and description as shown in Figure 24. After the user has successfully created a room type, he receives a message that the room type has been saved successfully, as shown in Figure 25.

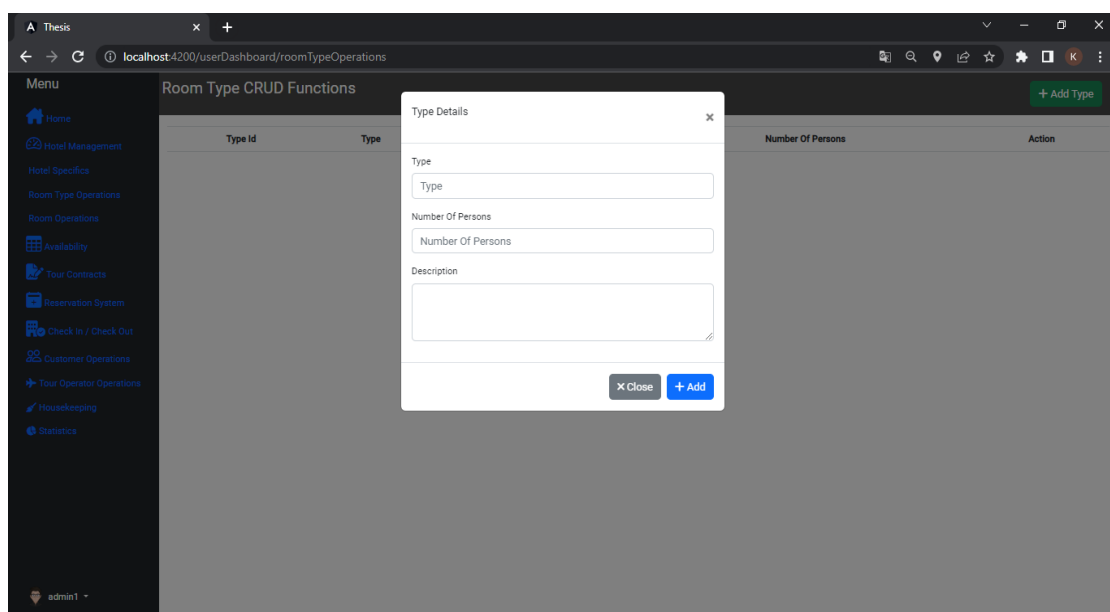

Figure 24 Create Room Types

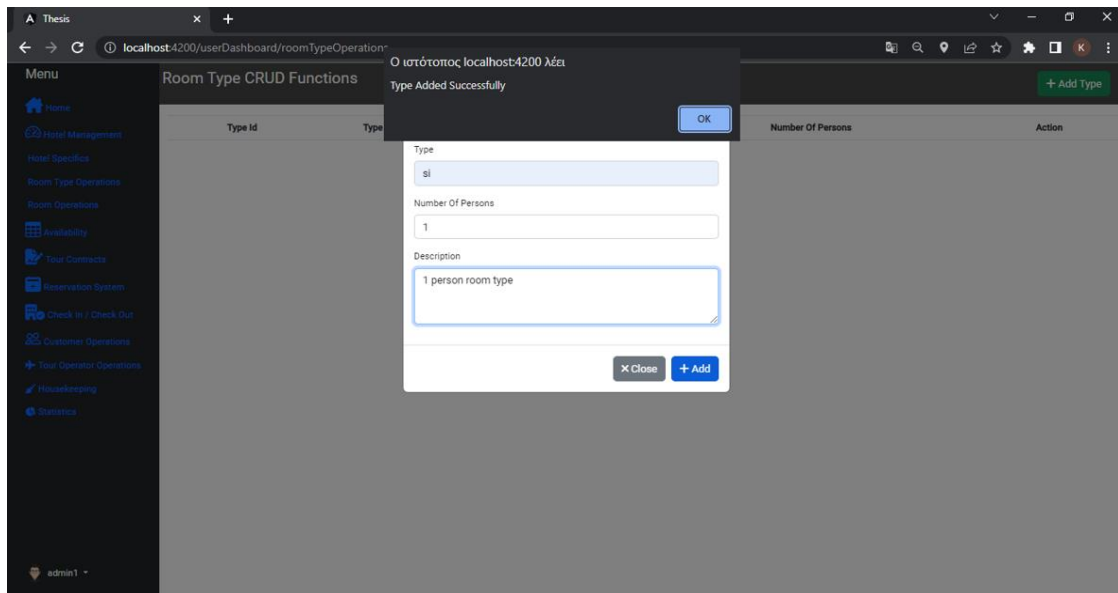

Figure 25 Room Type Added Successfully

The admin can then review the list of room types he has created and edit or even delete any that they no longer need as shown in Figure 26. In this example, 3 room types were created: si, db, and tr. Moreover, there is pagination with five entries per page to organize the content.

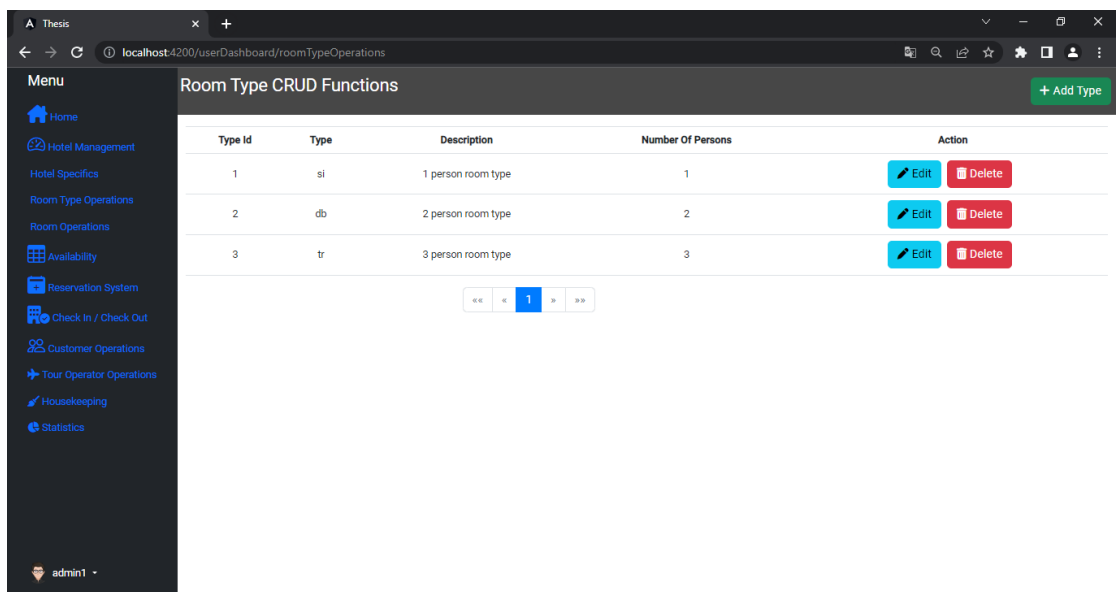

Figure 26 Room Types List

4.3.3 Room Module

By selecting the Room Operations option from the sidebar, the user is redirected to the Room Module where he can add rooms and assign them to the room types he has created. First, the admin must press the Add Room button in the top right corner and provide the required data, including the room's number, type, description, and status (cleaned, dirty,

needs inspection) as shown in Figure 27, and then click the Add button to the bottom of the form. After the admin has successfully created a room, he receives a corresponding message as shown in Figure 28.

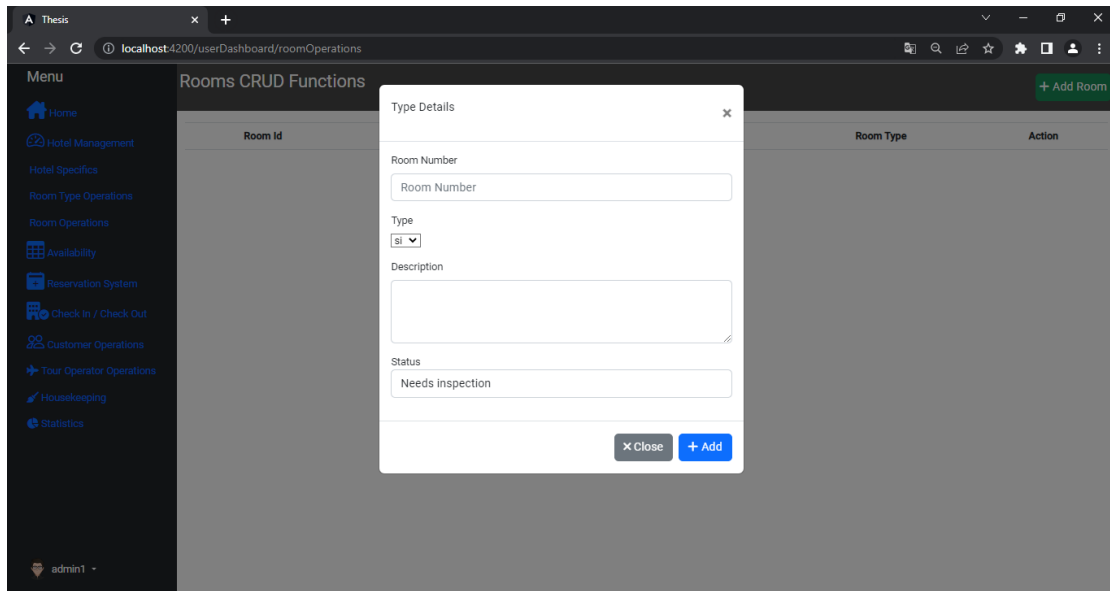

Figure 27 Create Rooms From

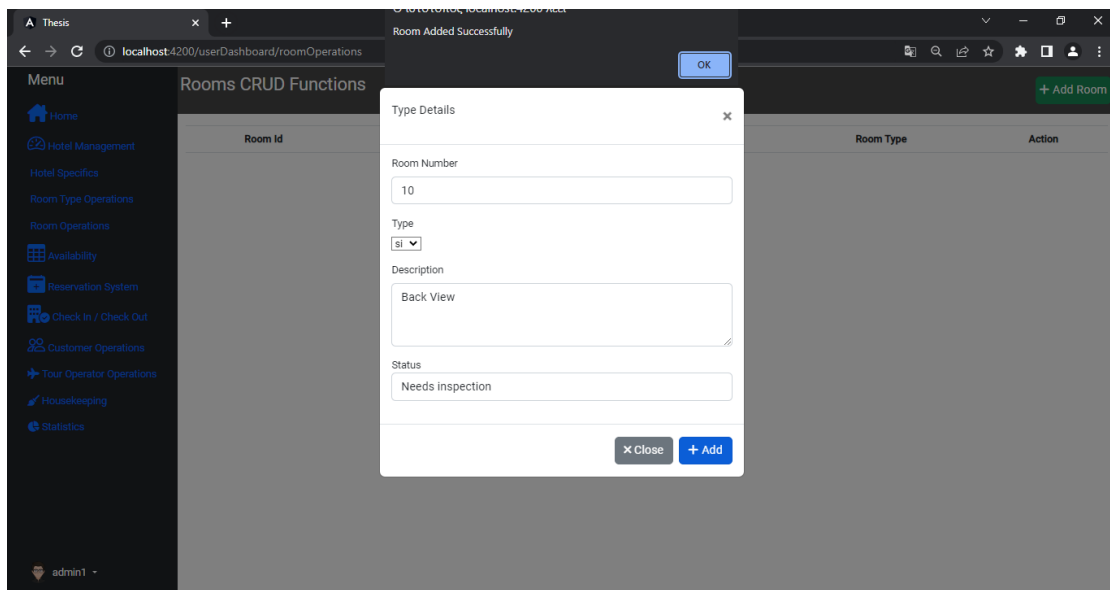

Figure 28 Room Form Completion

In this example, 6 rooms were created in total, 2 for each type of room we created earlier as seen in Figure 29. As can be seen from the room list, the user can view the rooms, edit them, create new ones, delete them, and finally add extra service charges to the customers which we will examine later after the rooms are checked in first. Furthermore, there is pagination with five entries per page for better organization of the content and we notice that the last room created has been moved to page 2.

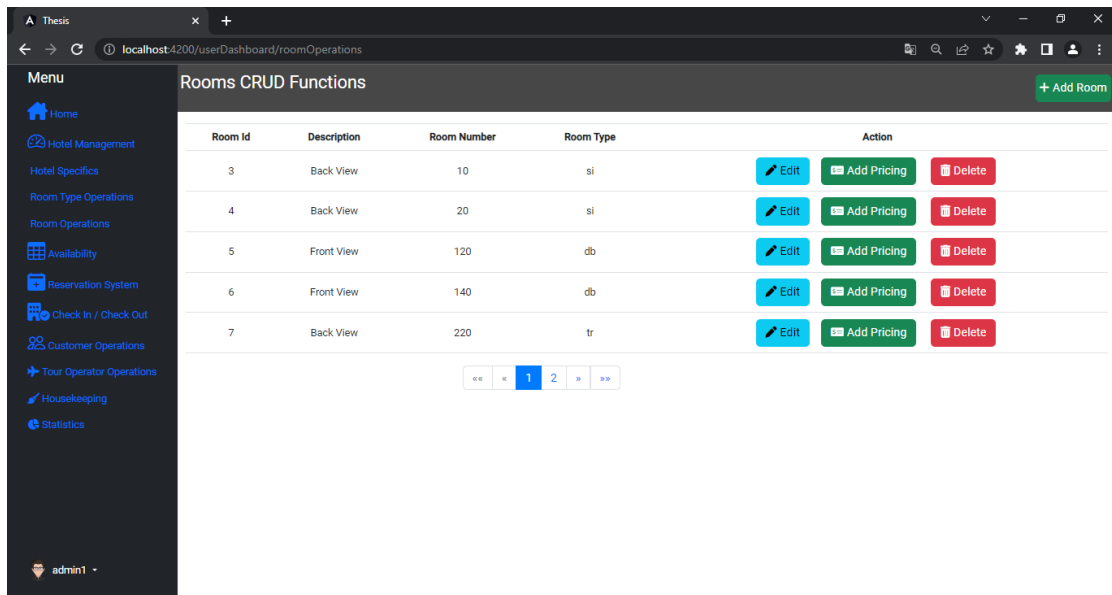

Figure 29 Room List

4.3.4 Tour Operators Module

The admin must choose the tour operators section from the sidebar in order to create tour operators. He can next choose the Add Tour Operator button (in the upper right corner) and enter the required data in the form as shown in Figure 30: name, phone number, and email. After adding the tour operator by clicking the Add button at the bottom of the form, the user will get the corresponding message.

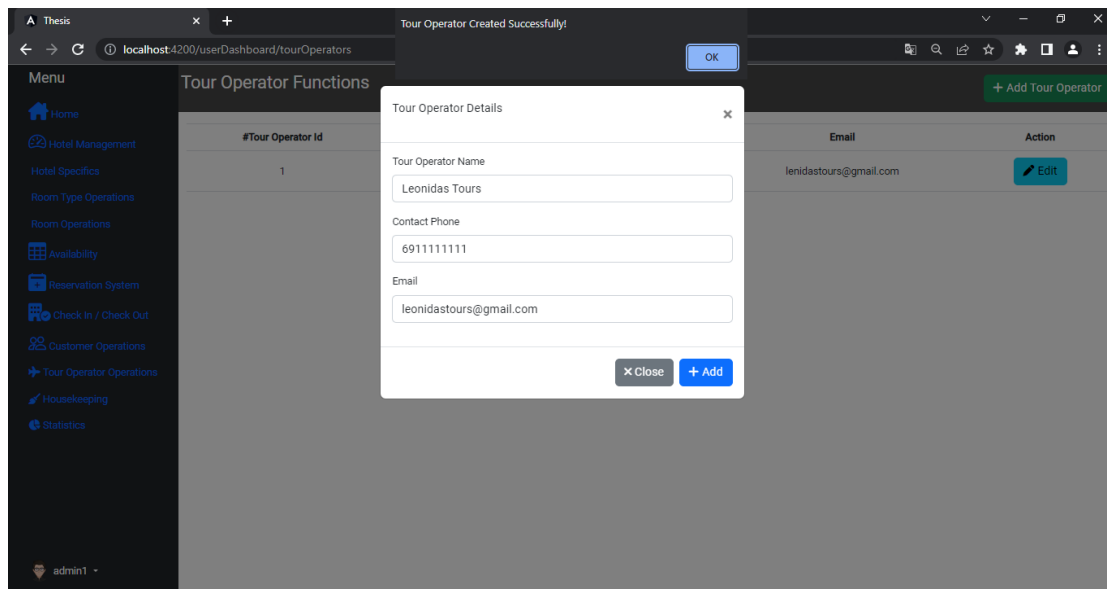

Figure 30 Tour Operator Creation

The admin can then edit and add tour operators from the list as shown below in Figure 31.

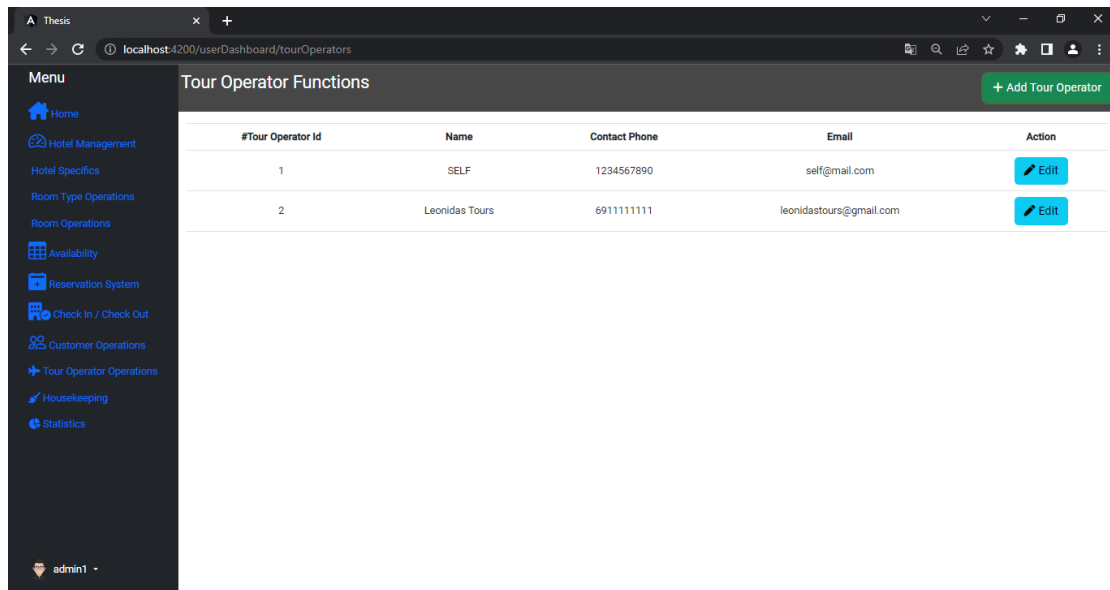

Figure 31 Tour Operator List

As shown below in Figure 32, if the admin tries to update or create a new tour operator with the same name, he gets an error message.

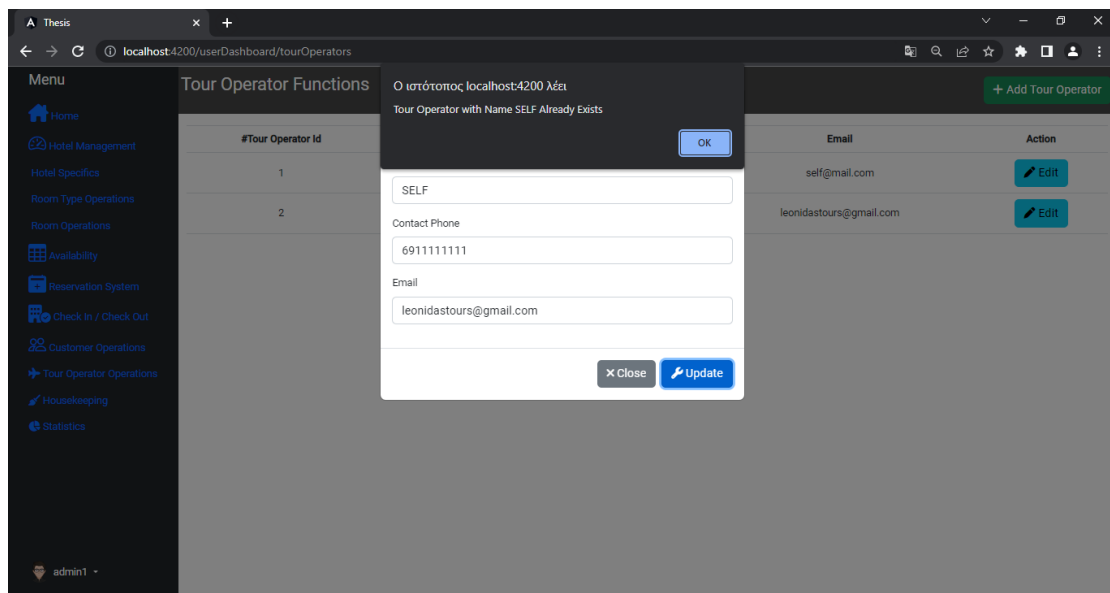

Figure 32 Error Creating Tour Operator

4.3.5 Tour Contracts Module

Use for Tour Operators

The admin can choose the tour contracts section from the sidebar in order to create tour contracts. He can then choose the Add Contract button (in the upper right corner) and enter the required data in the form as shown in Figure 33 which are the tour operator name, arrival, and departure date. After adding the contract by clicking the Add button at the bottom of the form, the admin will get the corresponding message.

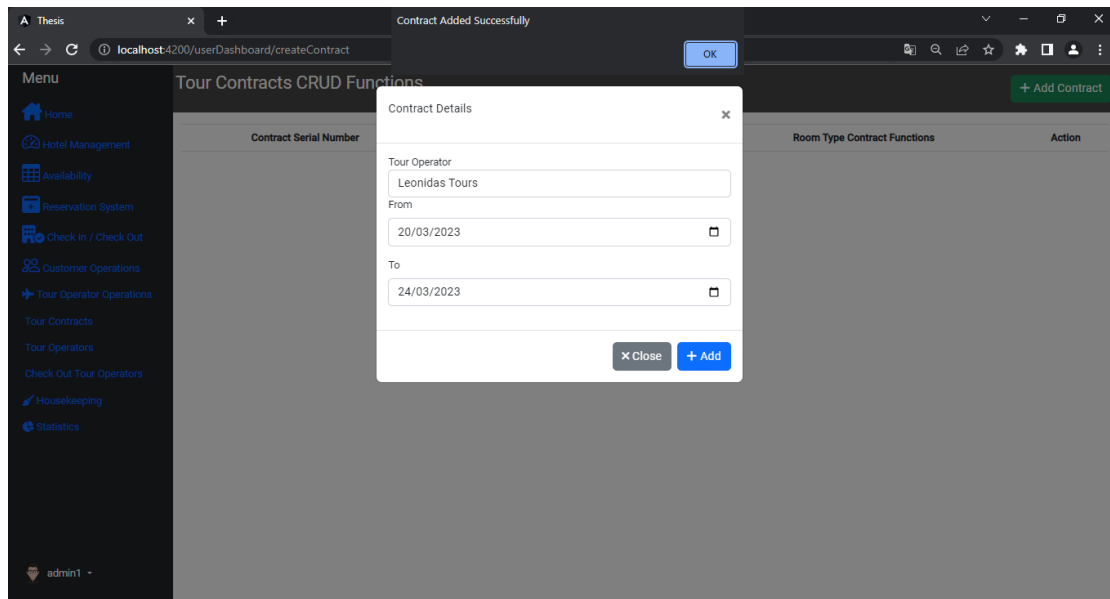

Figure 33 Tour Contract Creation

The admin can then edit, add, or remove contracts from the list as shown below in Figure 34. Also, we see that the table now has the Add Contract Type and View Contract Types functionalities which are represented, respectively, in Figures 35 and 36.

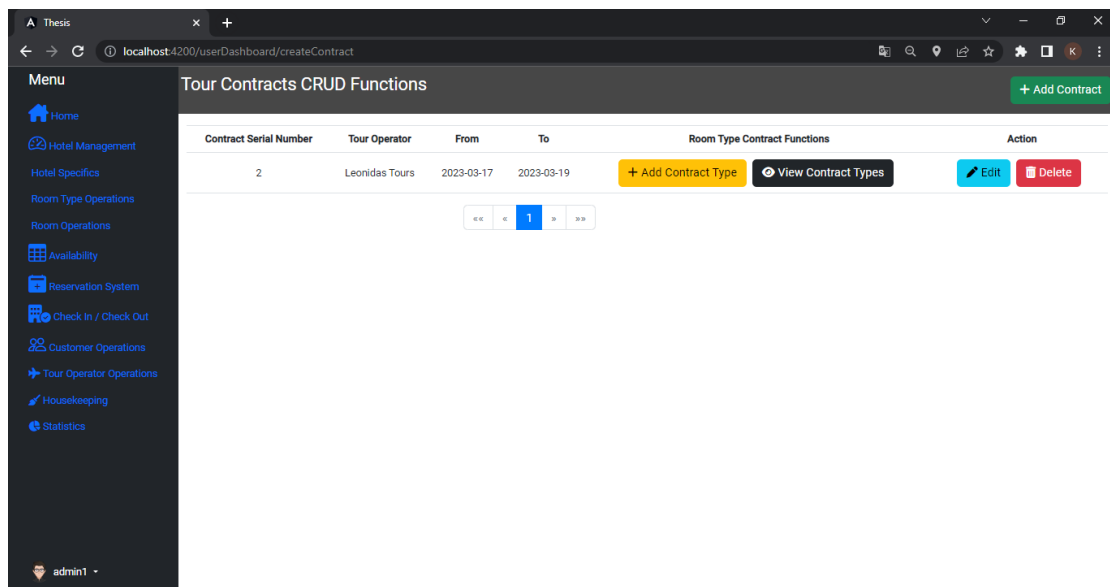

Figure 34 Tour Contracts List

Add Contract Types

The Add Contract Type option in the contracts table is shown in Figure 35. In order to add contract types to a contract, the admin must fill out the form with the relevant details, including the type of room, the number of rooms, the number of people, the terms (Halfboard, Fullboard, Breakfast, No Meals), the rent amount, and the related food price (food charge fields change dynamically depending on the selected package). Three contract

types were created in this example, with two rooms of each type (si, db, and tr) and breakfast.

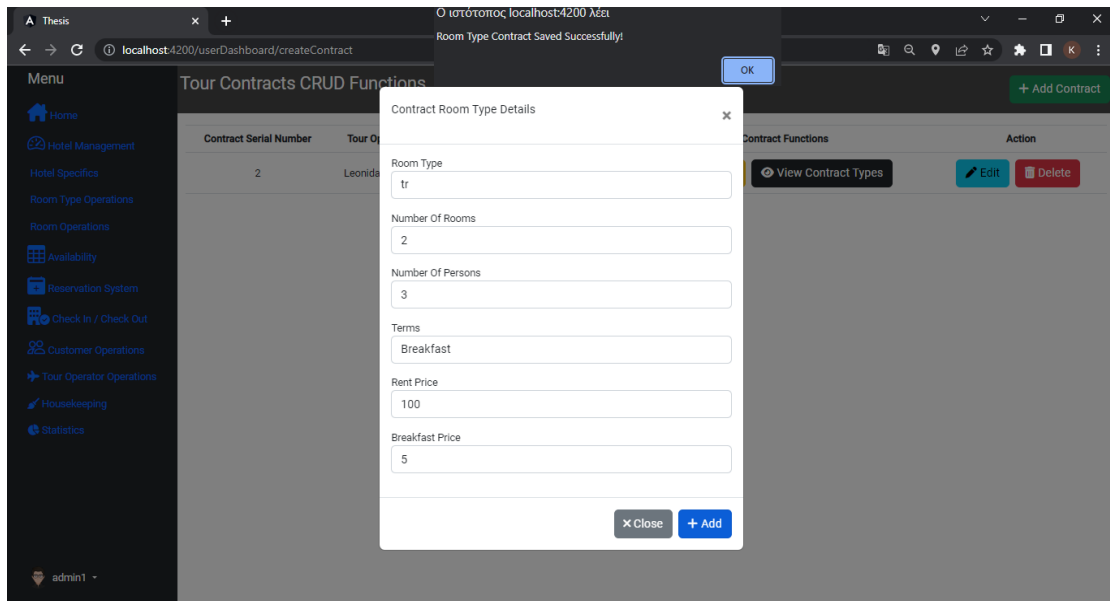

Figure 35 Add Contract Types to A Contract

View Contract Types

As depicted in Figure 34, the admin must click the View Contract Types option to view the types added to each contract. From there, the admin can change or remove the contract types from the list by selecting the appropriate button as shown in Figure 36.

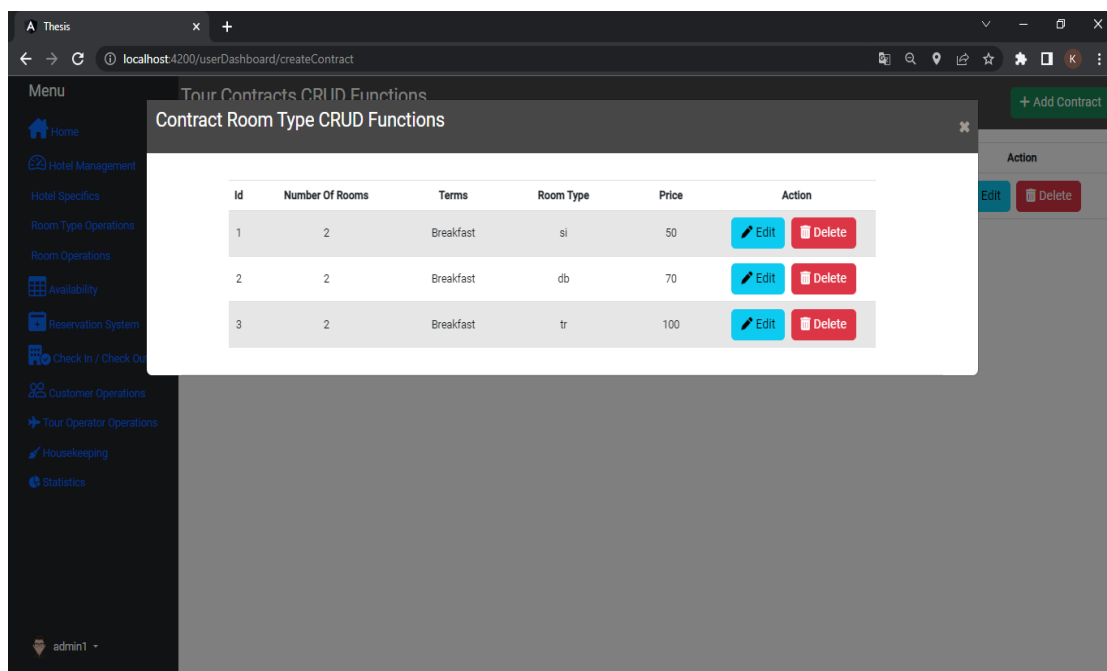

Figure 36 Contract Room Type CRUD Functions

Use for Self Hotel

In contrast to tour operators, who have agreements for a certain number of rooms, hotels use the contracts section to declare room rates for periods. In Figure 37 below, a Self-hotel contract is created and in Figure 38, forms are created where the price of the rooms is declared according to the period. The rest of the functions remain the same as described above in the "use for tour operators " section.

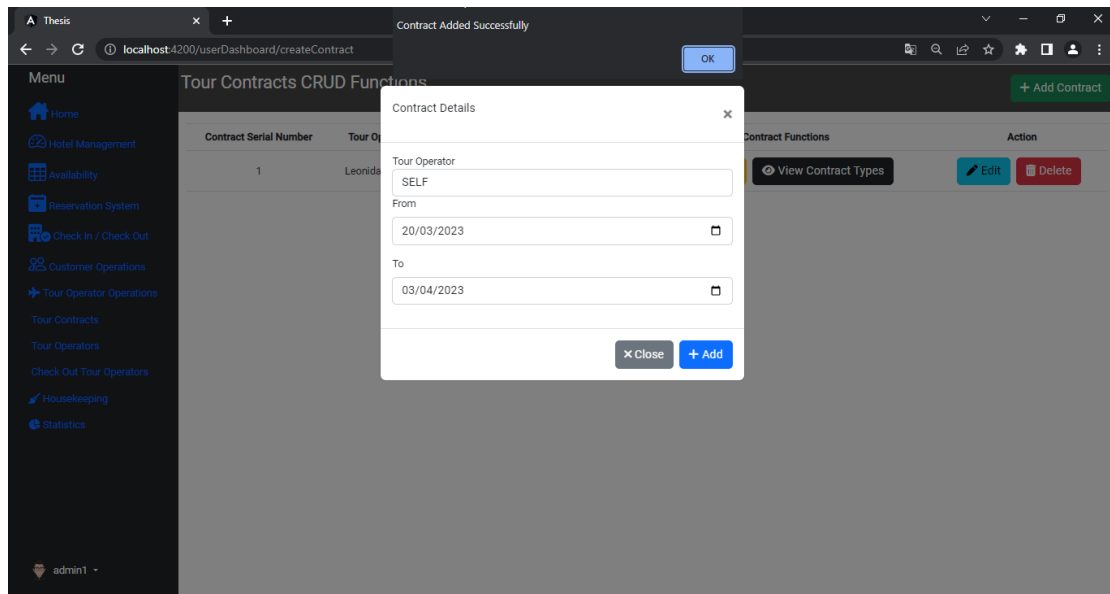

Figure 37 Self Hotel Add New Contract

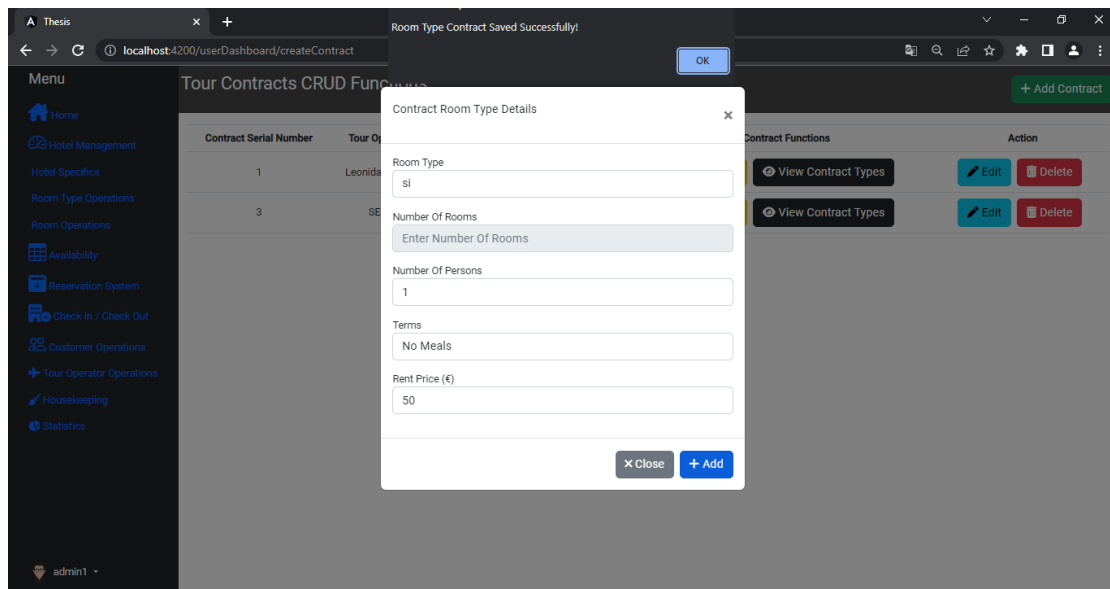

Figure 38 Self Contract Add Room Type

Update Contract

The admin has the option, if necessary, to change the contract's date range before check-in, as seen below in Figure 39. As a result, the availability is transferred to the new date that

was agreed with the tour operator. Regarding the Self-hotel, the modification of the time period of the contract results in the re-declaration of the pricing of room types for a different time period.

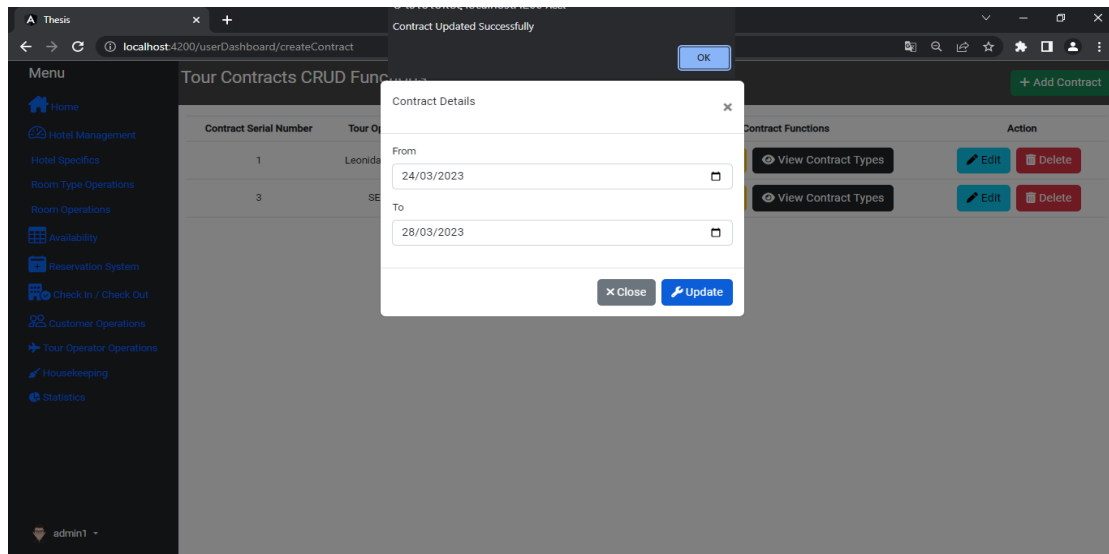

Figure 39 Update Contract

Contract Module Error Messages

The user is alerted with an error message as shown in Figure 40 if an attempt is made to create a new contract that contains the same tour operator, the same date range, or overlapping dates with another contract.

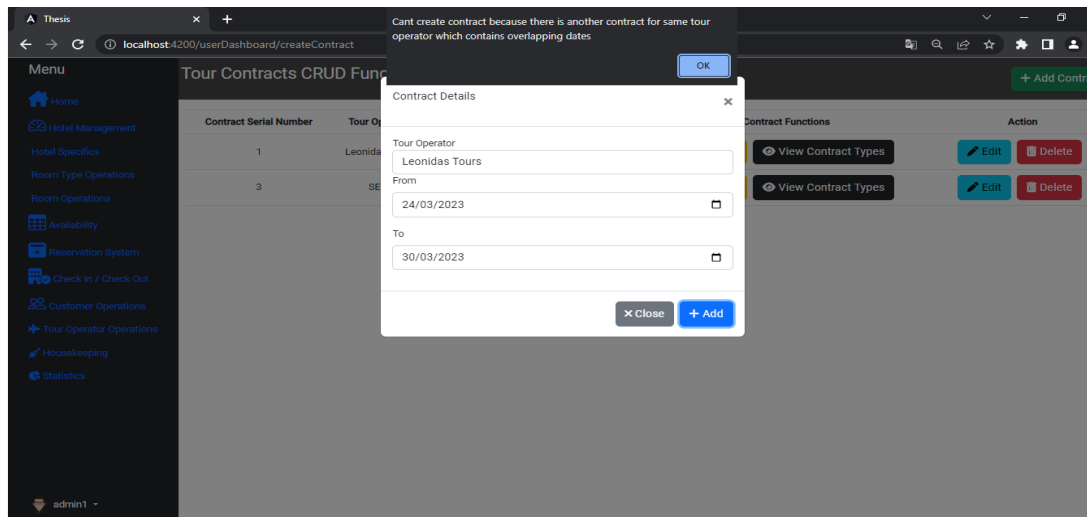

Figure 40 Error Creating Contract With Same Or Overlapping Dates

4.3.6 Reservation Module

The admin can choose the New Reservation option from the sidebar in order to create new reservations after the corresponding contracts were created. Admin can then choose the Add Reservation button (in the upper right corner) and enter the required data in the

form as shown in Figure 41 which are the tour operator name, reservation name, contact phone, and arrival and departure date. After adding the reservation by clicking the Add button at the bottom of the form, the admin will get the corresponding message.

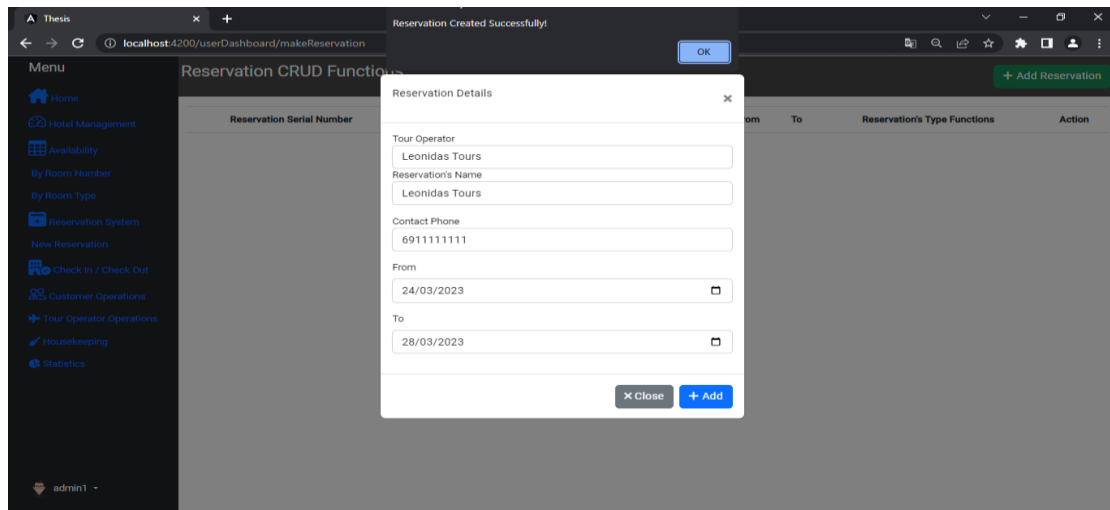

Figure 41 Error Creating Contract With Same Or Overlapping Dates

Now the admin can edit, add, or remove reservations from the list as shown below in Figure 42. Also, we see that the table now has the Add Reservation Type and View Reservation Types functionalities which are represented, respectively, in Figures 43 and 44. In this example, two reservations were created, one for Self-hotel and one for a tour operator.

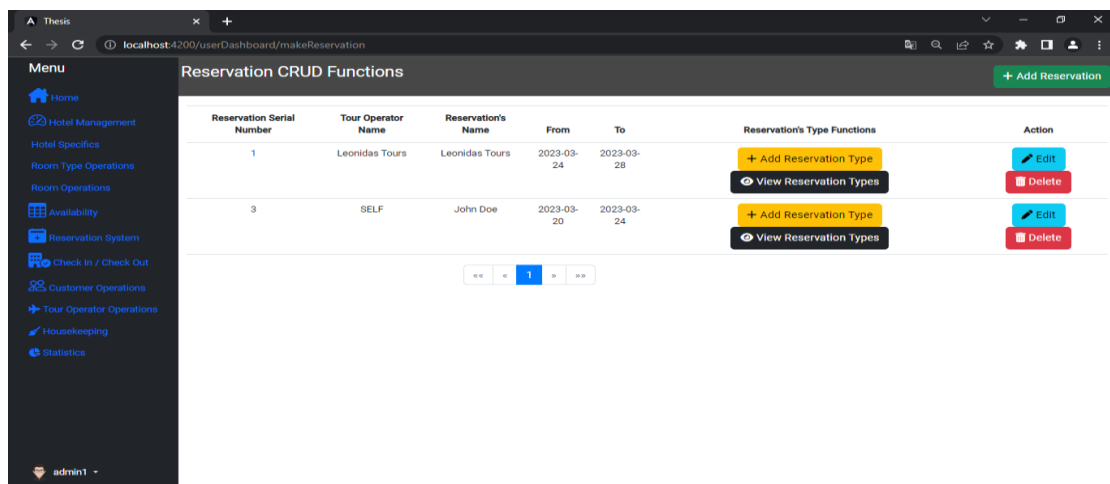

Figure 42 List Of Reservations

Add Reservation Types

The Add Reservation Type option in the reservation table is shown in Figure 43. In order to add reservation types to a reservation, the admin must fill out the form with the relevant details, including the type of room, the number of rooms, the number of persons, the

number of children, the terms (Halfboard, Fullboard, Breakfast, No Meals). Three reservation types were created in this example, with two rooms of each type (si, db, and tr) and breakfast.

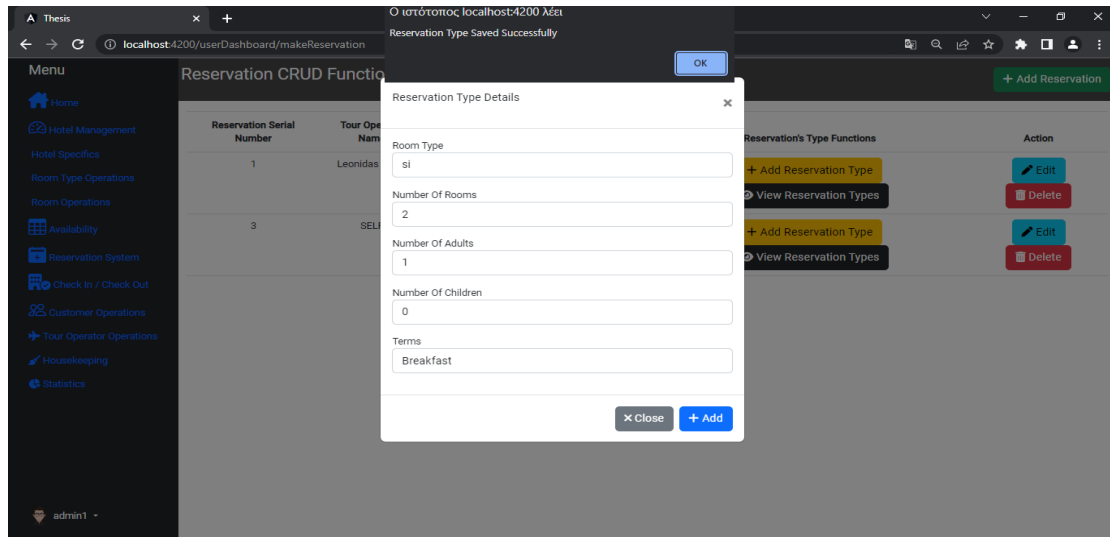

Figure 43 Add Reservation Types to A Reservation

View Reservation Types

As depicted in Figure 42, the admin must click the View Reservation Types option to view the types added to each contract. From there, the admin can change or remove the reservation types from the list by selecting the appropriate button as shown in Figure 44.

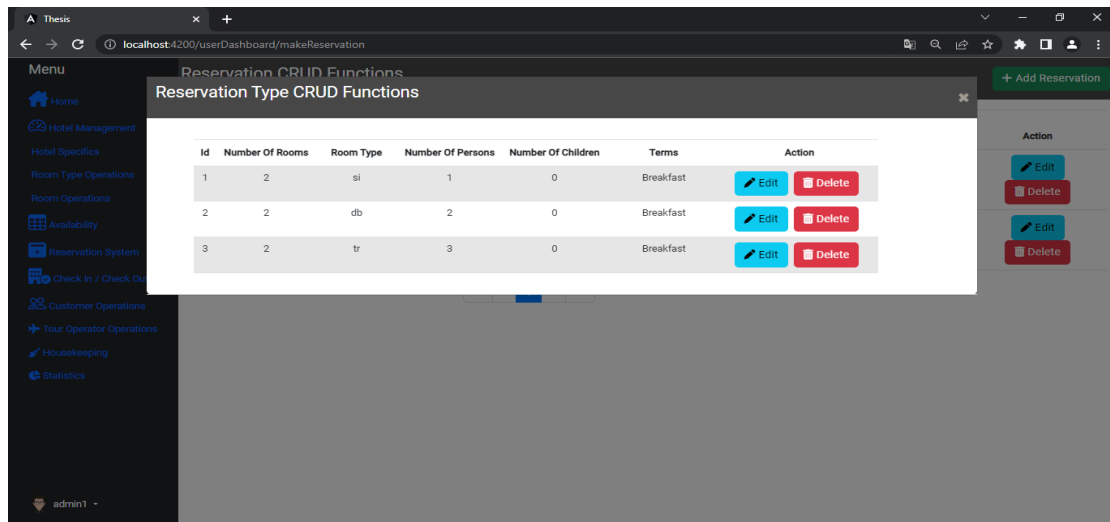

Figure 44 View Reservation Types

Reservation Module Error Messages

Figure 45 shows the error message that the admin may receive if he tries to create or update a reservation without first creating a corresponding contract (same tour operator,

same arrival and departure dates) and Figure 46 shows the error message in case the admin attempts to book more rooms than are available during a specific date range.

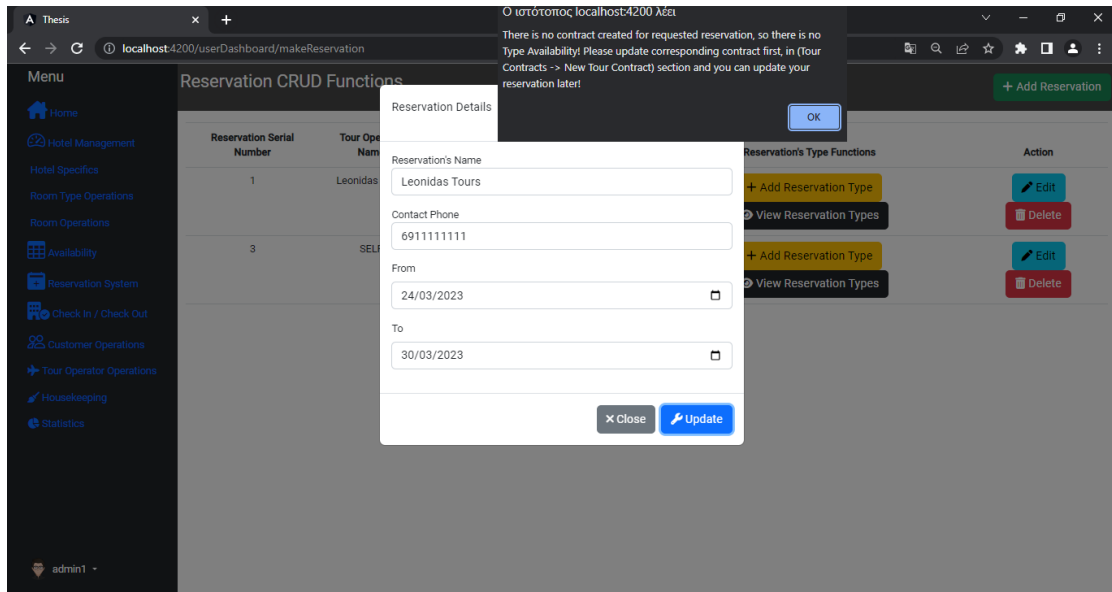

Figure 45 There is no corresponding contract error message

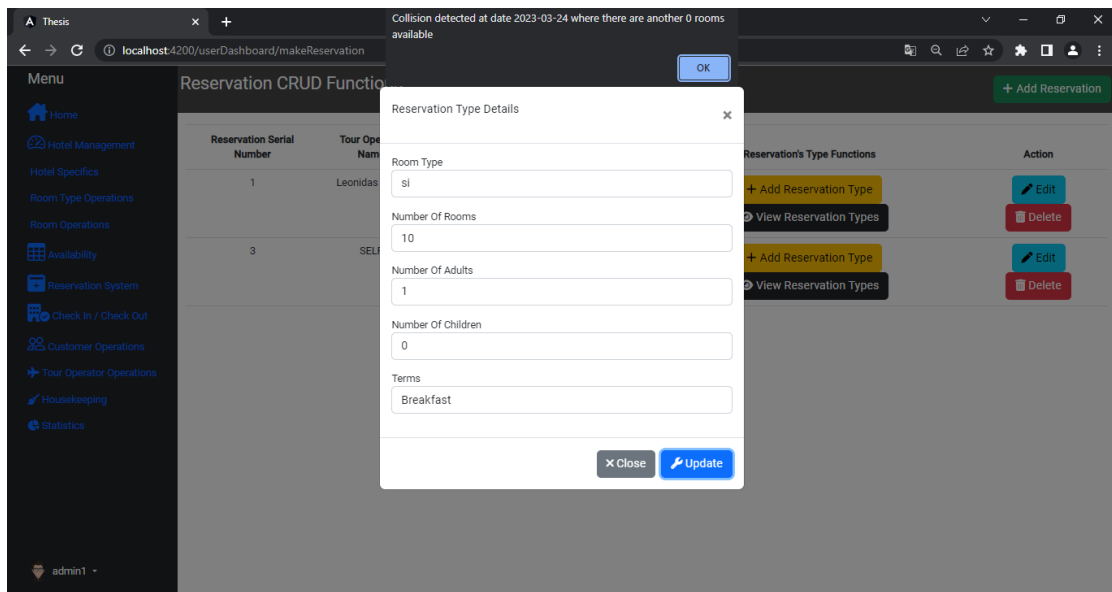

Figure 46 There is no availability for given dates error

4.3.7 Check-In Operations Module

Figure 47 below shows the Check-In Board where the admin can see the arrival list by current date or by selecting a date using the previous and next buttons located at the top right of the Module. Also, we notice that the status of the reservation is Pending. By pressing the View Reservation Types button, the admin can see the list of check-ins for each reservation according to the room type as shown in Figure 48.

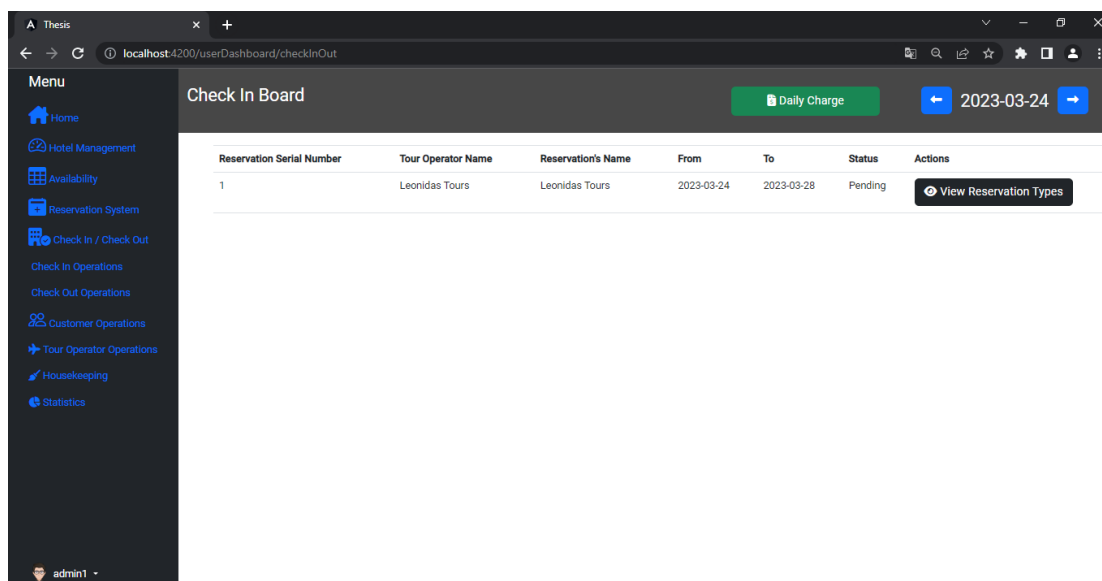

Figure 47 Check-In Board

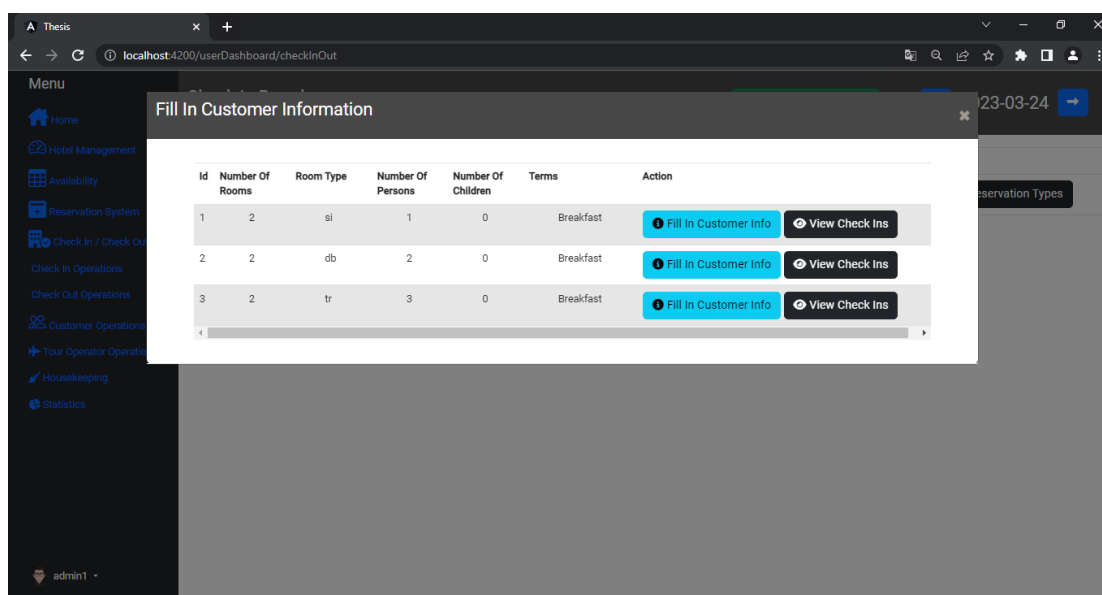

Figure 48 Arrival Room Types

Fill In Customer Info

By selecting the Fill in customer info button, the admin can fill in the form required to fill in the customer's details to check in as shown in Figure 49. These details are divided into two sections, the required and the non-required. This happens to allow a quick check-in, while the non-required data that was not completed can be added later to the Customer Module as we will see below. The required details are first name, last name, contact phone, email, and passport. The non-required details are the country, city, address, and zip code. With the Show/Hide Customer Non-Required Info option, the user can hide and display the non-required information. The room number field is a dropdown that automatically displays the available rooms by number.

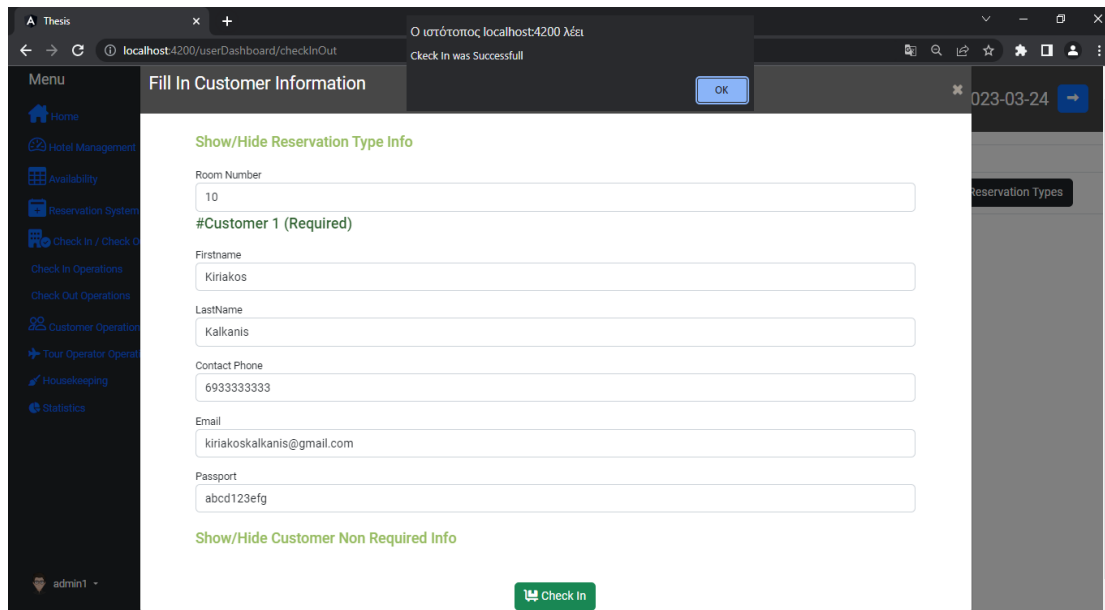

Figure 49 Check-In Customer Form

Once all customers have checked in, each reservation type is considered completed. For example, the type with Id = 1 in Figure 48 will be considered complete after two check-ins are done, one for each room, the type with Id = 2 will be considered complete when two customers check in for each room, and the type with Id = 3 will be considered complete once all three check-ins for each room are done. When all required check-ins have been completed, the Fill In Customer Info Button is disabled because the reservation types are considered complete as seen in Figure 50 and the reservation's status automatically turns from "Pending" to "Checked In," as shown in Figure 51 below.

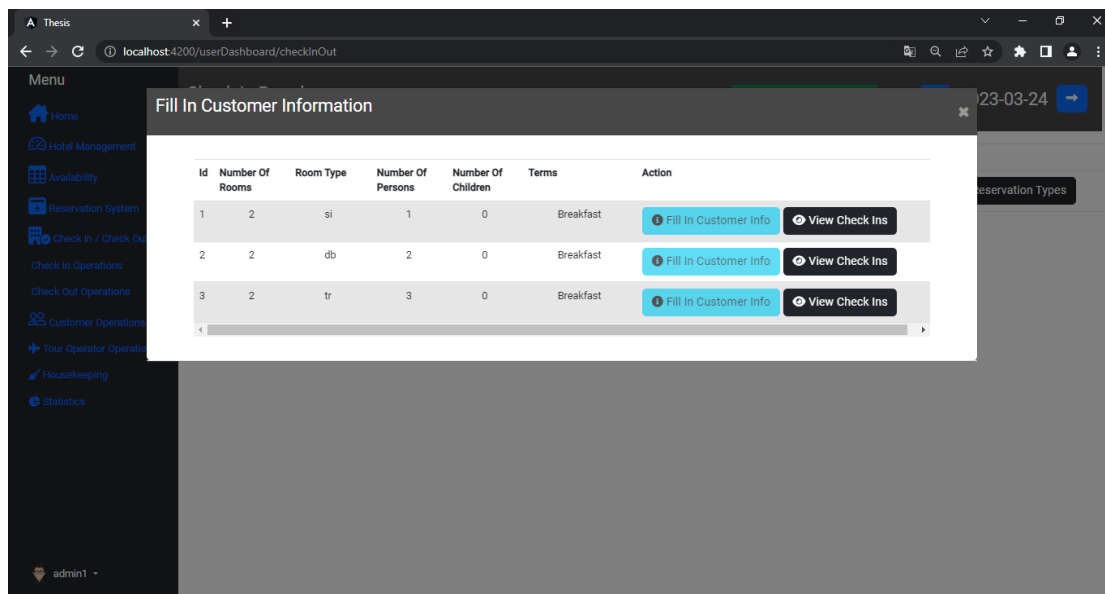

Figure 50 Complete Check-Ins

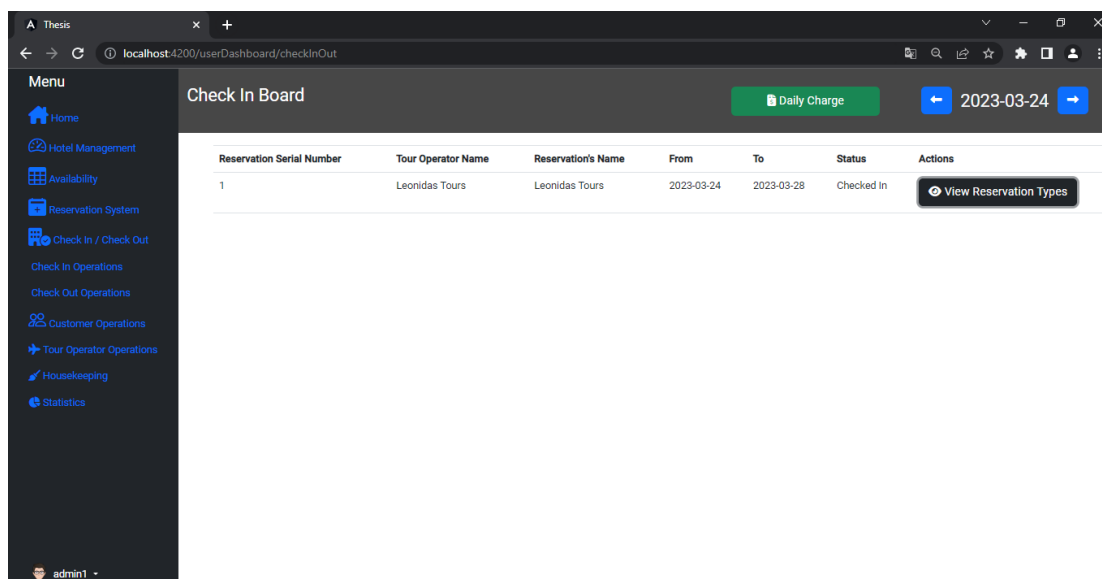

Figure 51 Arrival Status Changed From Pending To Checked In

View Check-Ins

By pressing the View Check-Ins button for each type as shown in Figure 50 above, the admin can see which customers have checked in as shown in Figure 52 below.

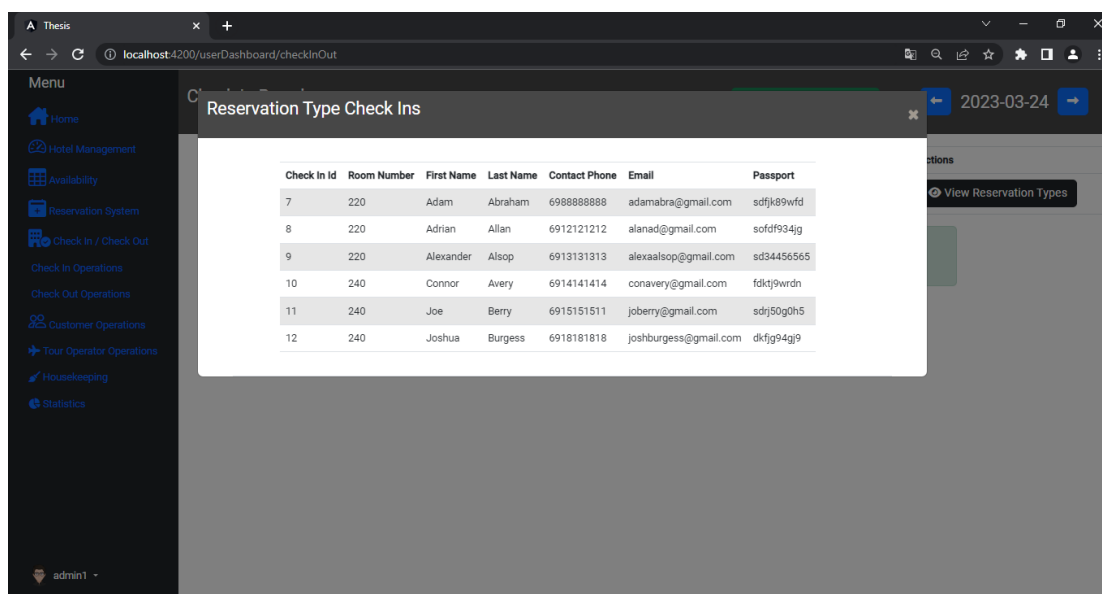

Figure 52 View Check-Ins Per Room Type

Daily Charge

As seen in Figure 51 at the top of the application there is an option for Daily Charge. This is a procedure that the admin must do at the end of each day after all the check-ins have been completed in order to calculate the overnight expenses for each tour operator or hotel customer if the reservation concerns Self-Hotel reservations. There are 3 cases of messages that the admin can receive regarding the daily charge option:

- If the admin has not made a daily charge for any date that includes customers in the hotel as shown in Figure 53.
- If the admin has successfully carried out the daily charge operation as shown in Figure 54.
- If the admin has carry out the daily charge option before all the necessary check ins for all reservations have been completed as shown in Figure 55.

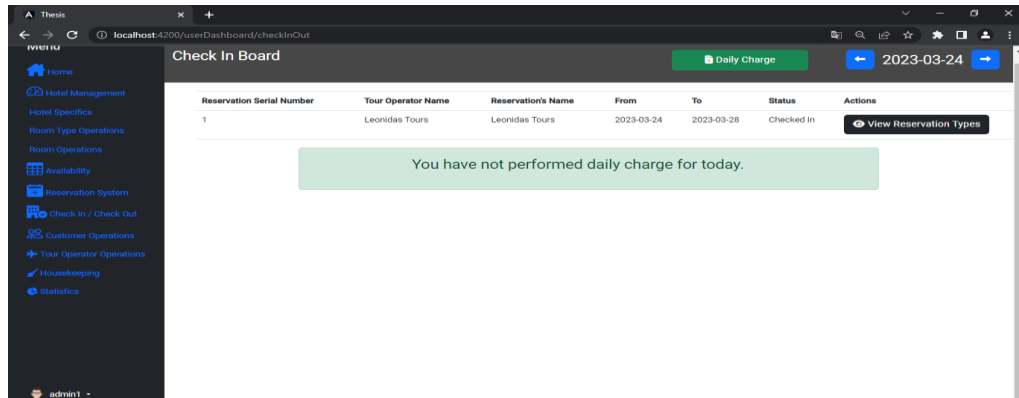

Figure 53 Daily Charge Has Not Carried Out

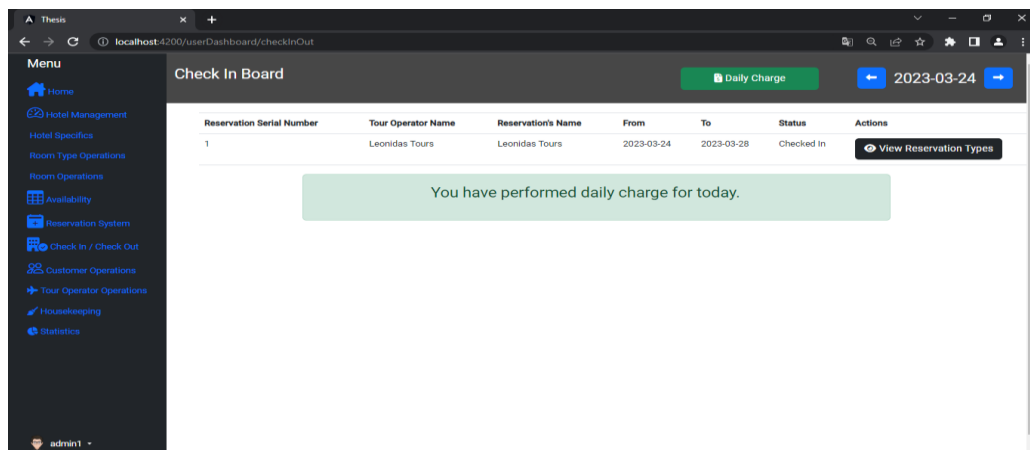

Figure 54 Successful Daily Charge

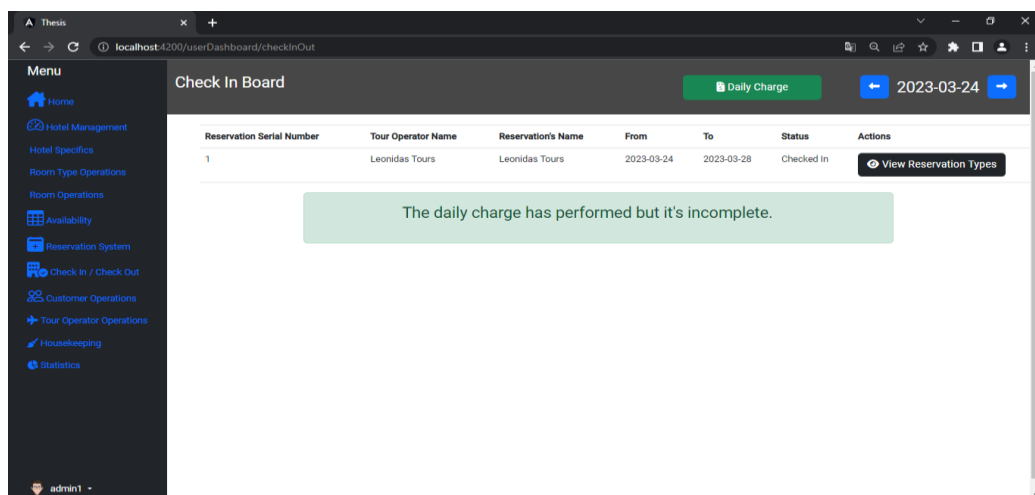

Figure 55 Incomplete Daily Charge

Overbooking

Figure 56 illustrates how the system permits overbooking. Due to the frequent cancellations and hotels' constant need to sell every available room, it is a widely used strategy in the hospitality sector. Of course, the person using the program should be careful and completely aware of the availability so that there are no issues.

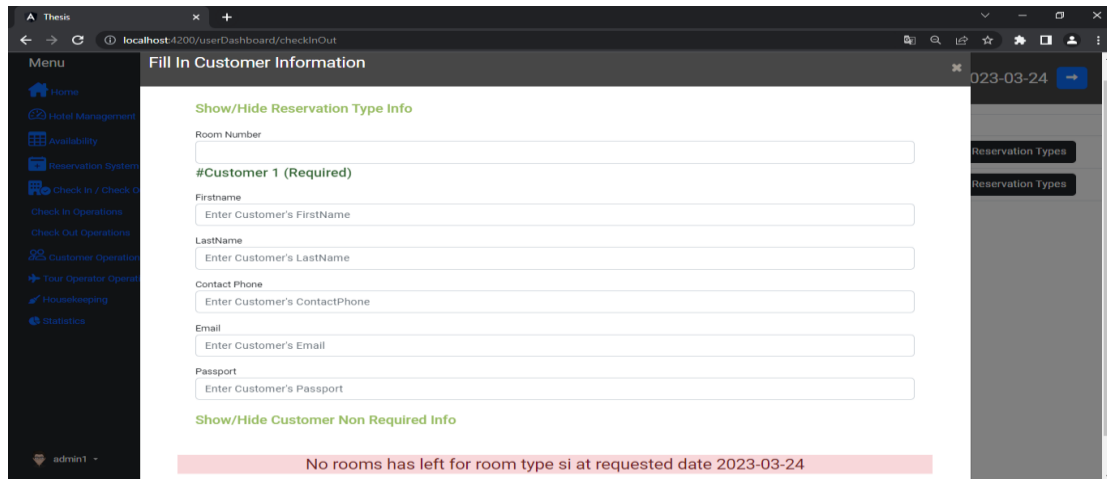

Figure 56 Overbooking

4.3.8 Availability Module

The admin has the option of viewing the availability by room type as shown in Figure 57 or by room number as shown in Figure 58 by selecting from the sidebar the Availability Section and then choosing Availability By Room Type or Availability By Room Number respectively. The admin can also see which customers have checked in to each room by hovering in room blocks.

Availability By Room Type

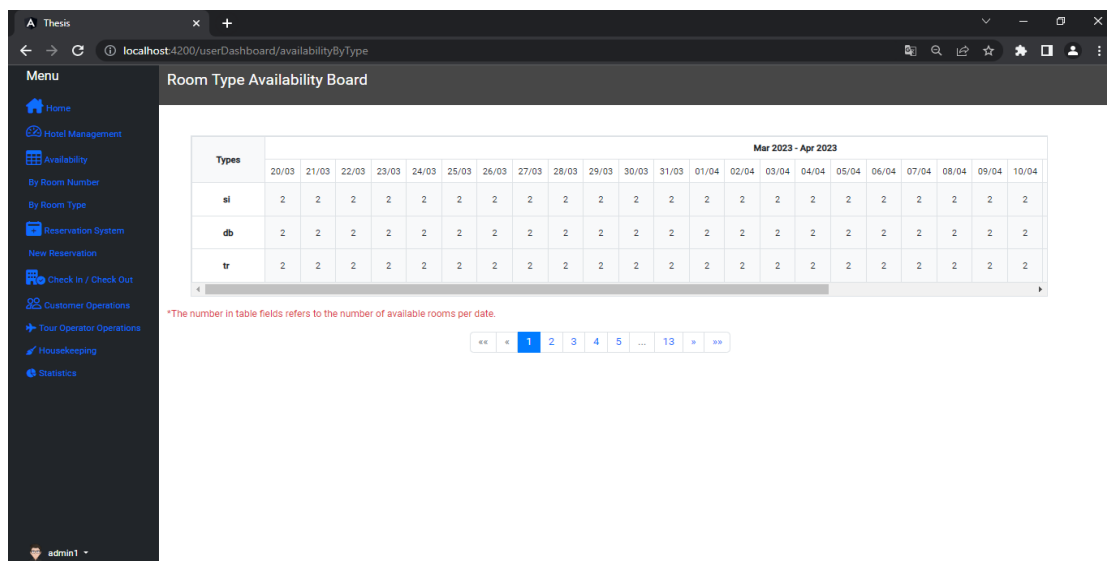

Figure 57 Availability By Room Type

Availability By Room Number

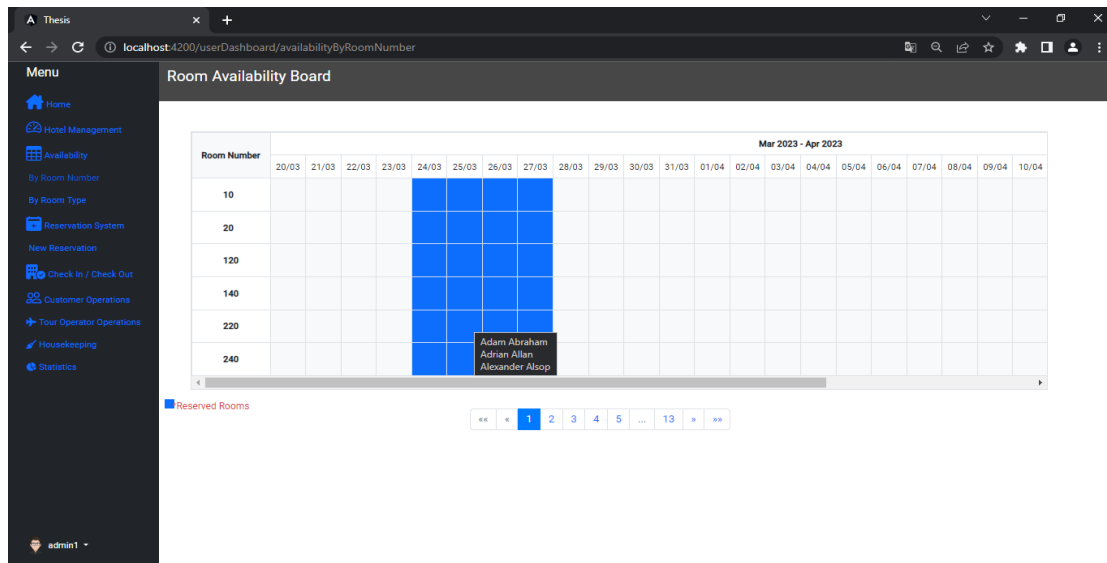

Figure 58 Availability By Room Number

4.3.9 Additional costs for extra services

The admin has the option to charge additional costs for extra services per room and customer. To perform this action, he should go to the Room Module and select the Add Pricing button that is placed in the list next to each room as shown in Figure 29 above in 5.3.3 Room Module. Figure 59 depicts the charging of additional services. The customer field is a dynamically updated dropdown that displays the customers who have rented a specific room. After the admin selects the customer to charge, he can then add the price to the price field, fill in the description about the service purchased and select the Charge button. Then, a corresponding message is sent that the charge was successfully made.

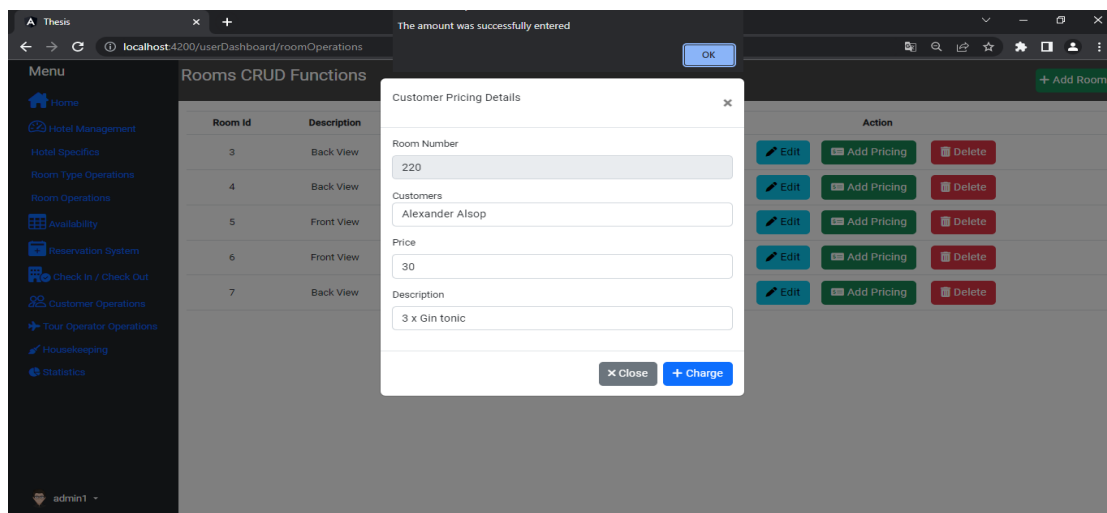

Figure 59 Charge Additional Costs

4.3.10 Check Out Operations

Tour operators' Customers Use Case

Customers who visit the hotel and have made a reservation through a tour operator are only charged for the extra services since they have already paid the tour operator who is responsible for the overnight stay costs.

Figure 60 below shows the Check-Out Board where the admin can see the departure list by current date or by selecting a date using the previous and next buttons located at the top right of the Module. Also, we notice that the status of the reservation remains Checked In. By pressing the View Reservation Types button, the admin can see a list of the reservation types of the reservation as shown in Figure 61.

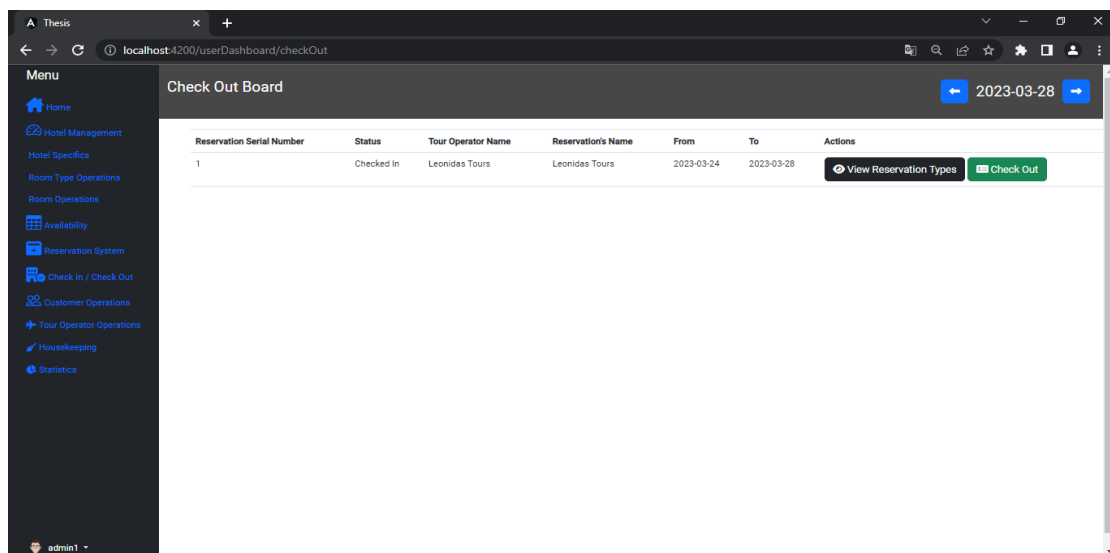

Figure 60 Check-Out Board

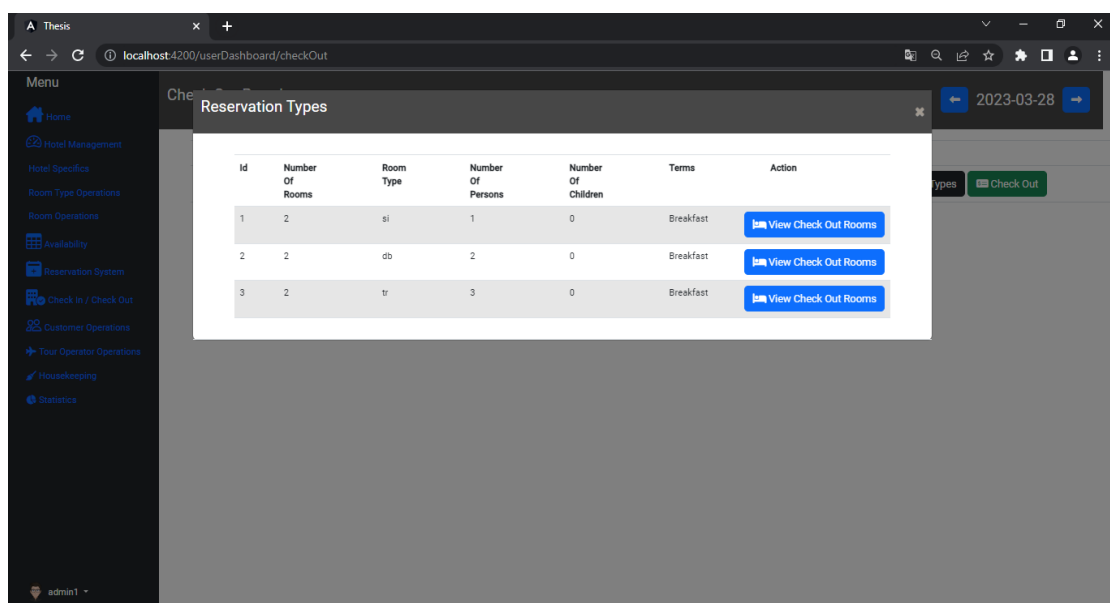

Figure 61 View Reservation Types To Check Out

Then by pressing the Check-Out Rooms button located next to each reservation type as shown in Figure 61 above, the admin can see a list of rooms that must be checked out on the specific date as shown in Figure 62 below.

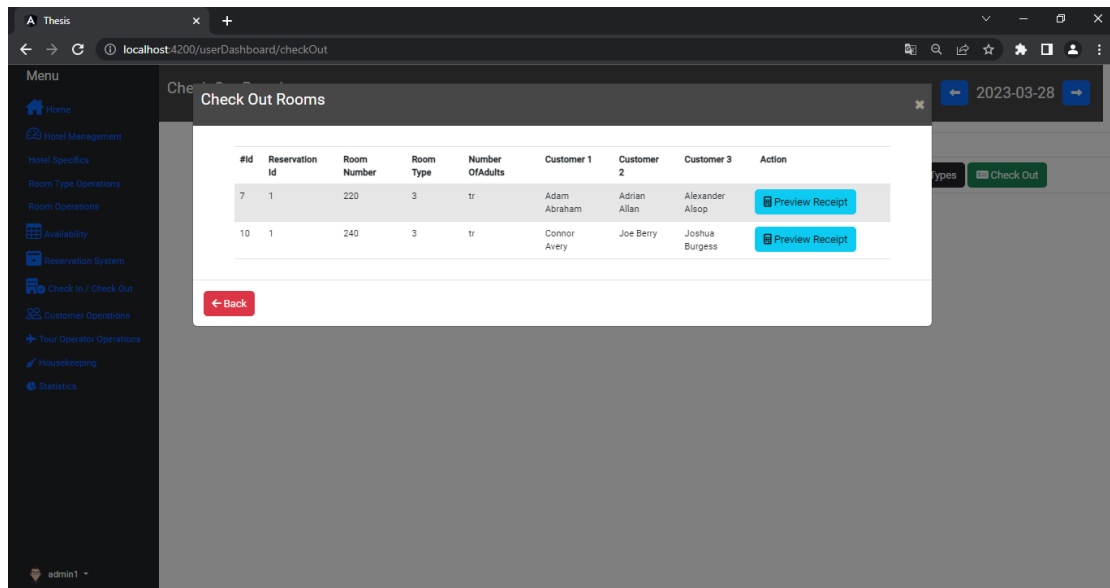

Figure 62 List Of Rooms To Check Out

Then by selecting the Preview Receipt button, the admin can make a preview of all customer receipts that belong to the selected room. Receipts are generated dynamically for each user and can be printed if needed by clicking the "Generate Receipt" option as shown in Figure 63 below.

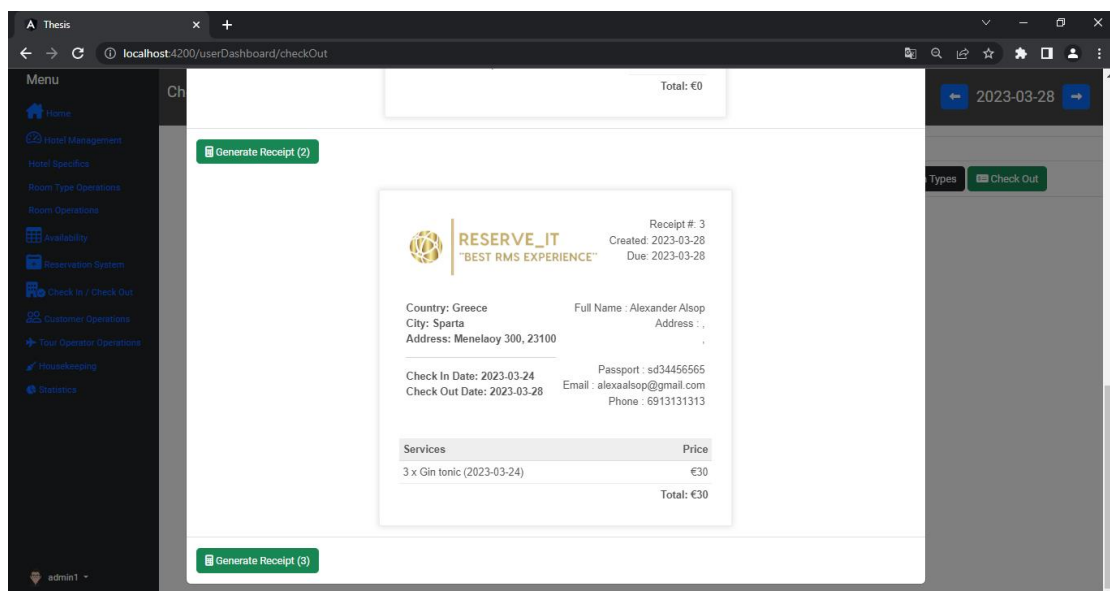

Figure 63 Preview Receipts

The reservation expenses can then be seen in advance by clicking the Check Out button in Figure 60. The Check Out / Payment button, which can be seen in Figure 64, must be

pressed in order to check out the reservation. Then we notice in Figure 65 that the status of the reservation has successfully changed to "Checked Out" from "Checked In".

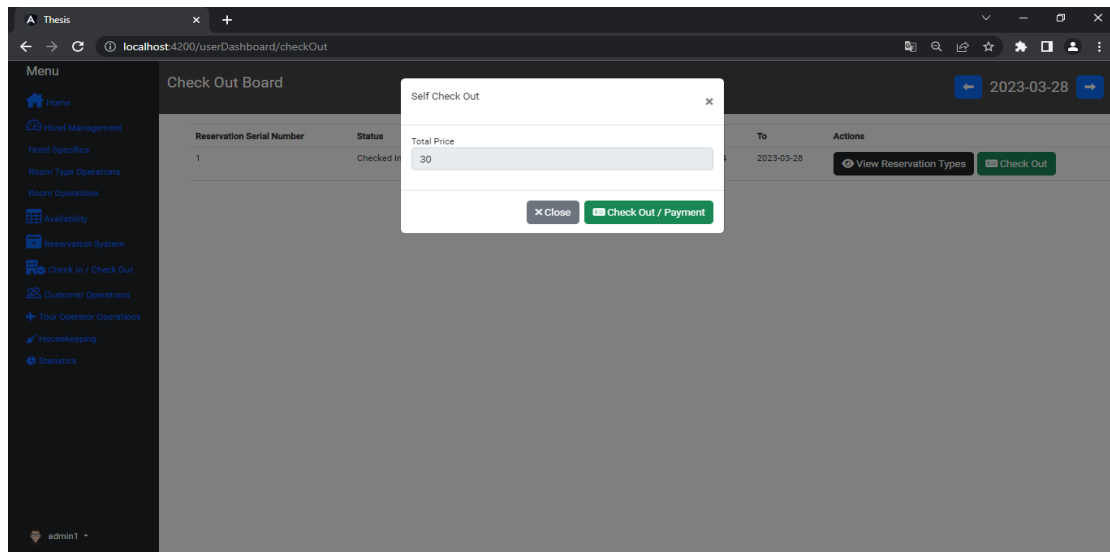

Figure 64 Expenses Preview & Checkout

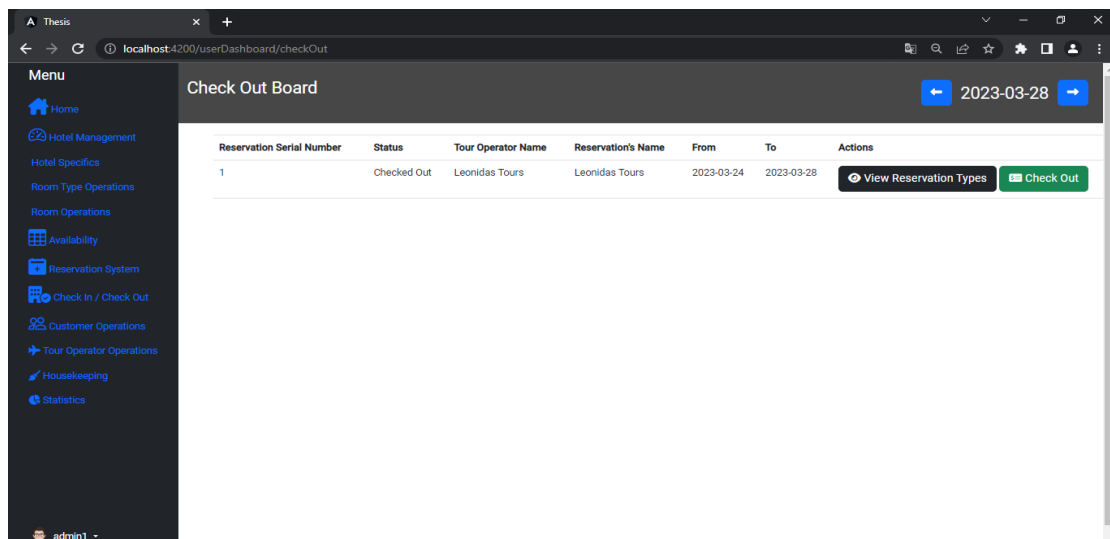

Figure 65 Checked Out Reservations

Hotel Customers Use Case

Guests who visit the hotel and have made a reservation through the hotel are charged for both hotel extras and overnight expenses. The person who made the reservation is the obligated customer who is responsible for covering overnight expenses. Figure 66 depicts the receipts that are generated for a customer who has made a reservation through the hotel, in which case he is charged for overnight stays while also being charged for extra purchased services. The rest of the process to check out remains the same as shown in Figure 64.

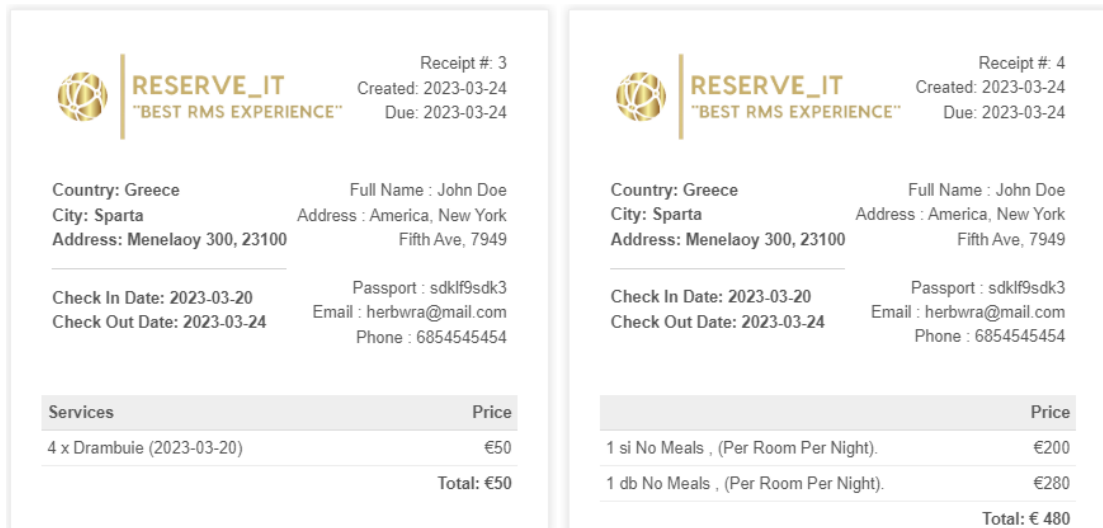

Figure 66 Extra Services & Overnight Stays Receipts

4.3.11 Check Out Tour Operators Board

Figure 67 below shows the Check-Out Board where the authorized user can see the departure list that includes tour operators either by current date or by selecting a date using the previous and next buttons located at the top right of the Module. By pressing the Check Out button, the user is transferred to the credit system where the specific tour operator can either pay off the whole debt or pay off a part of it. If any part of the amount is not paid, it remains in the account of the specific tour operator. Figure 68 below depicts an example of a full payout.

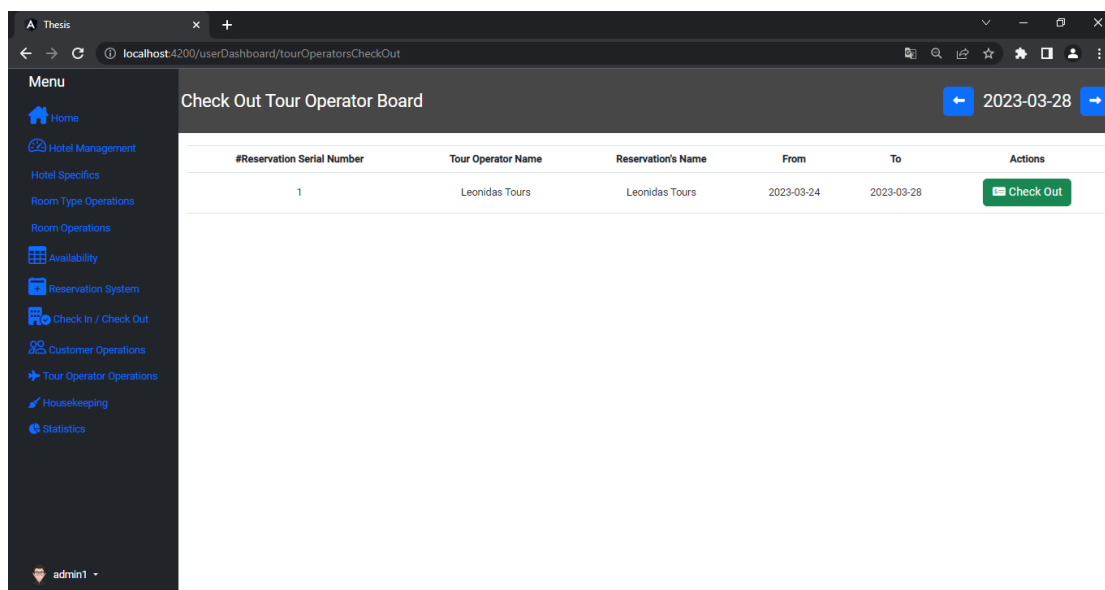

Figure 67 List Of Tour Operators To Check-Out

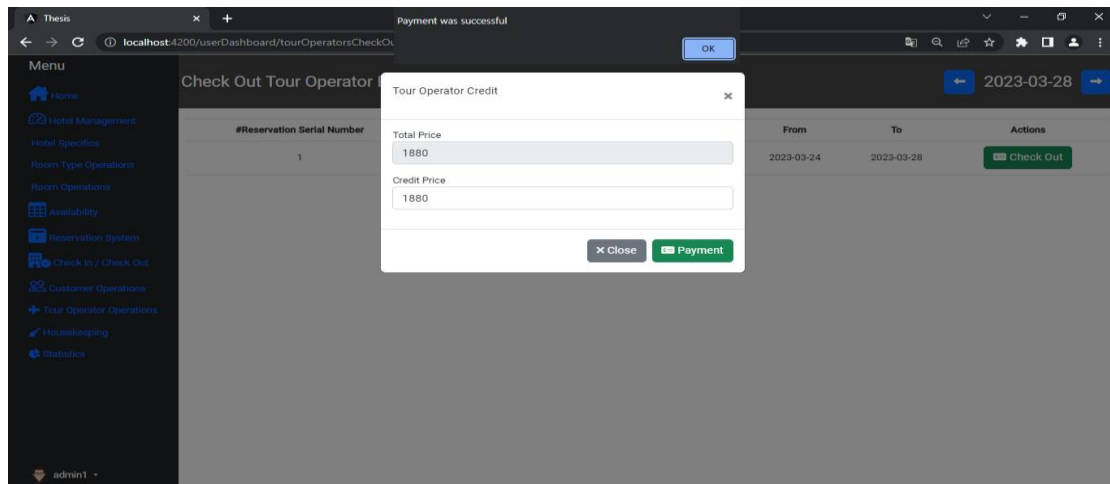

Figure 68 Full Payout

4.3.12 Statistics Module

By choosing the Statistics Module from the sidebar and choosing a year from the dropdown menu, the authorized user can view stats through bar charts like revenue and visitors per month and year as shown in Figures 69 and 70 respectively.

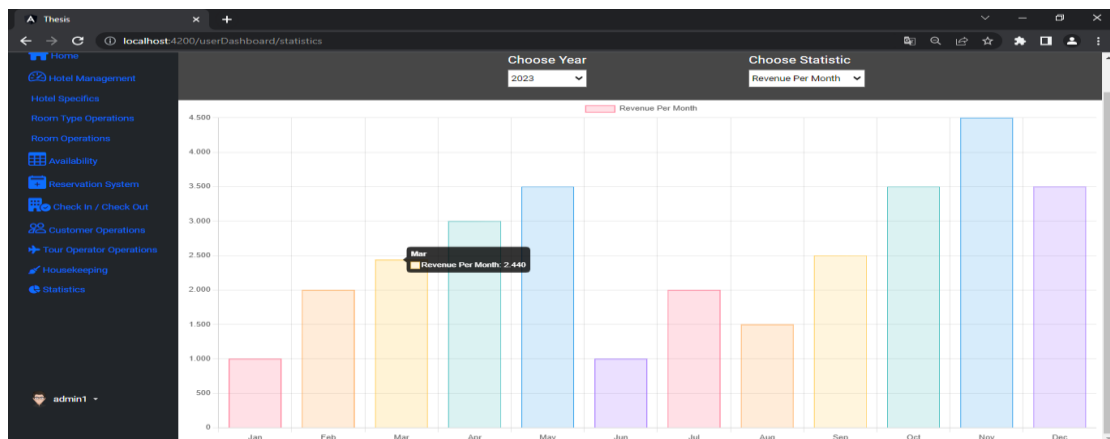

Figure 69 Revenue Per Month And Year Statistic

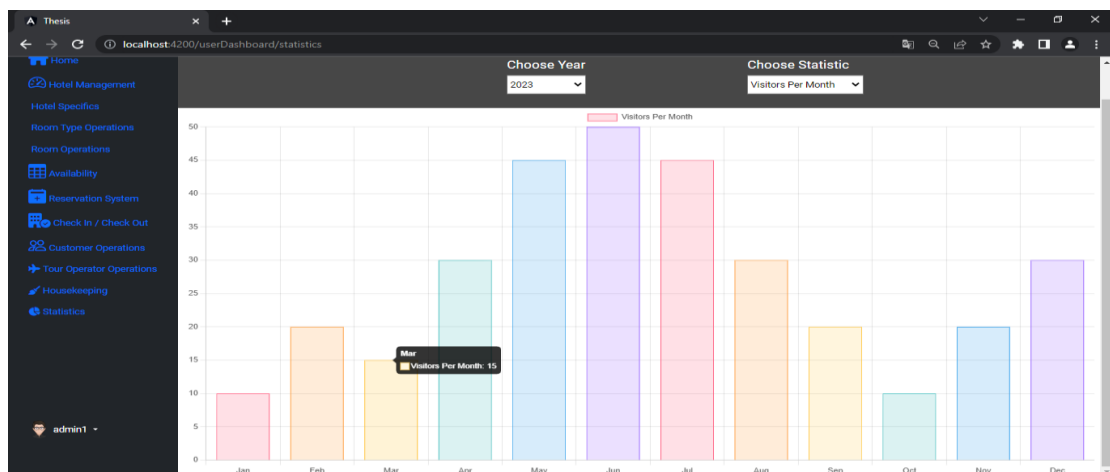

Figure 70 Visitors Per Month And Year Statistic

4.3.13 Customer Module

By selecting the Customer Section from the sidebar, the admin can view customer details and edit them. There is also a filter to display customers in ascending or descending order as well as a search bar as seen in Figure 71.

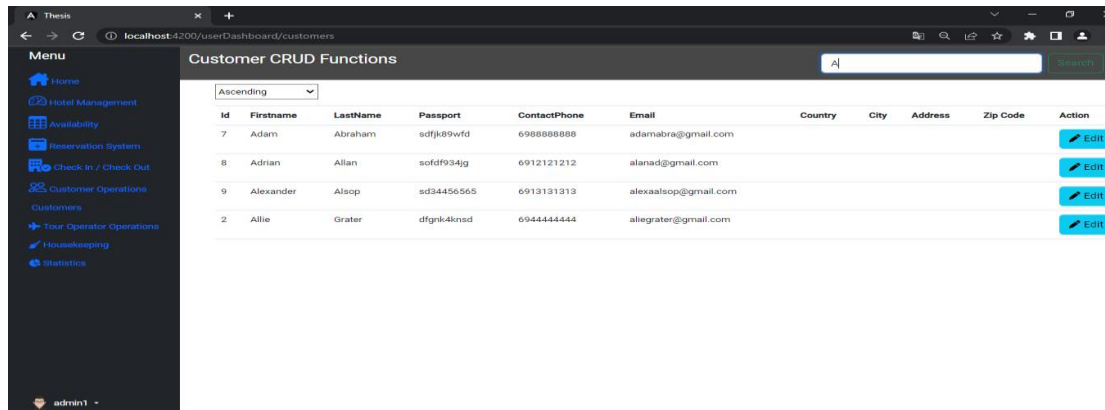

Figure 71 Customer Module

4.4 Housekeeping Staff Use Case Scenario

When a user with Housekeeping Staff privileges logs in to the system he is redirected to Housekeeping Module. As we can see in Figure 72, most of the features are blocked in the sidebar because he has limited options in contrast to admin.

4.4.1 Housekeeping Module

The housekeeping staff has the option to see a donut graph with the percentages of clean, dirty, and needing inspection rooms. When the staff is cleaning or inspecting the rooms they can select the toggle button shown in the list of rooms in Figure 72. The donut graph is updated dynamically.

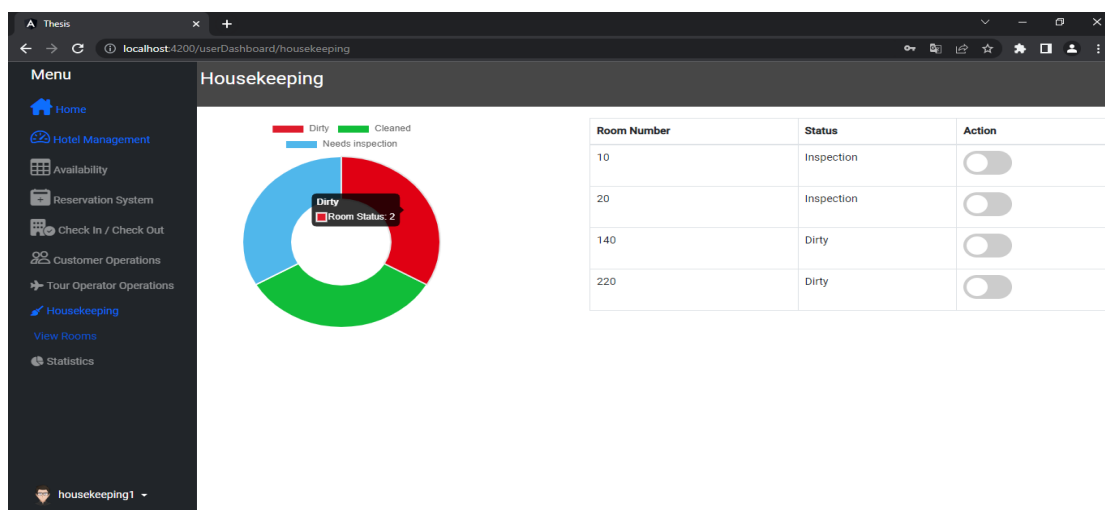

Figure 72 Housekeeping Module

4.4.2 Room Status Update

As shown below in Figure 73, the housekeeping staff also has the option to update the room status through the Room Module.

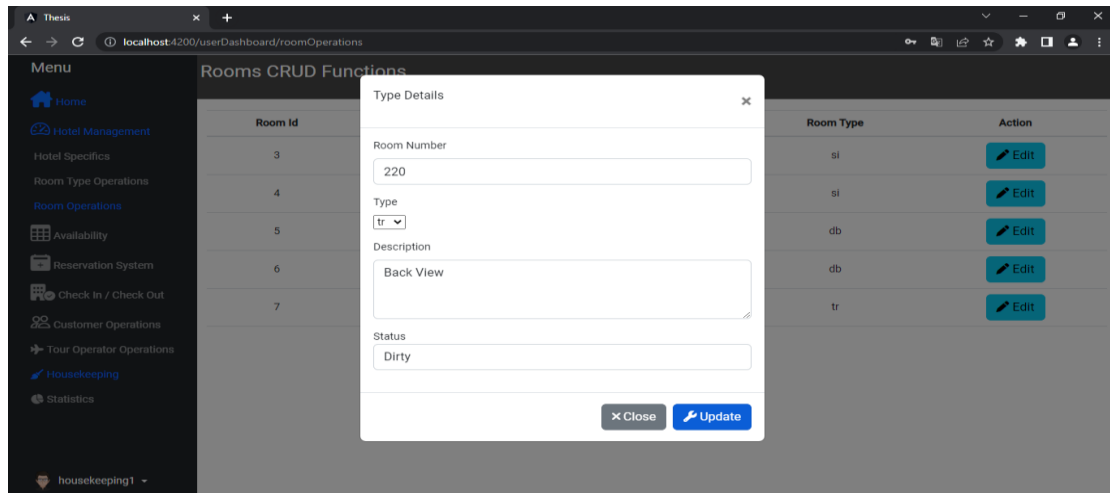

Figure 73 Update Room Status

4.5 Bar / Restaurant Staff Use Case Scenario

When a user with Bar / Restaurant Staff privileges logs in to the system he is redirected to Room Module. As we can see in Figure 74, users with Bar / Restaurant Staff privileges as well as users with Housekeeping Staff privileges have limited capabilities in contrast to admin. Figure 74 depicts the charging of additional services. The customer field is a dynamically updated dropdown that displays the customers who have rented a specific room. After the user selects the customer to charge, he can then add the price to the price field, fill in the description about the service purchased and select the Charge button.

4.5.1 Room Module – Charge Additional Services

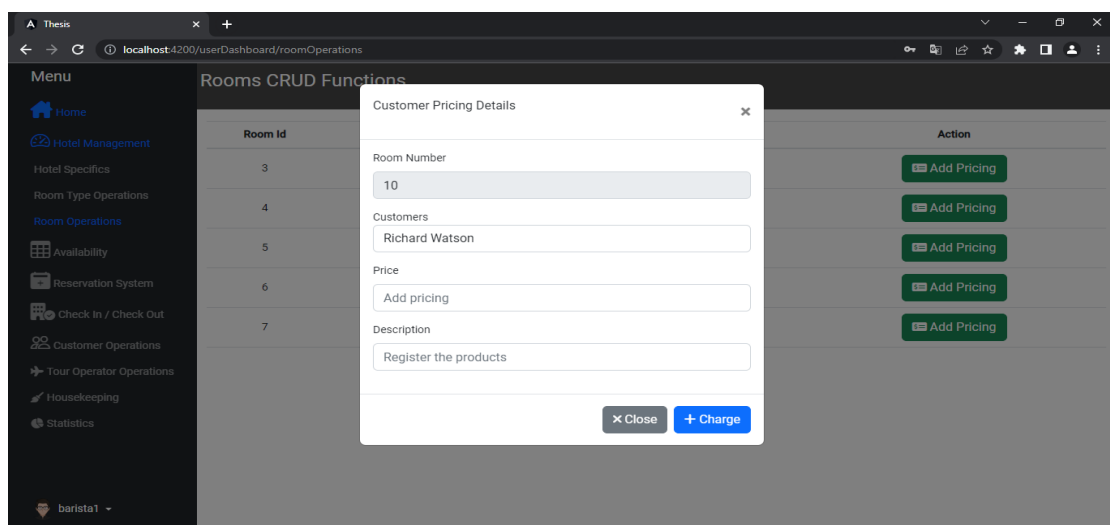

Figure 74 Extra Service Charge On Room And Customer

4.6 User Profile

All user roles by selecting the Profile option at the bottom of the sidebar have privileges to view and modify their account information such as username, password, and email as shown in Figure 75 below.

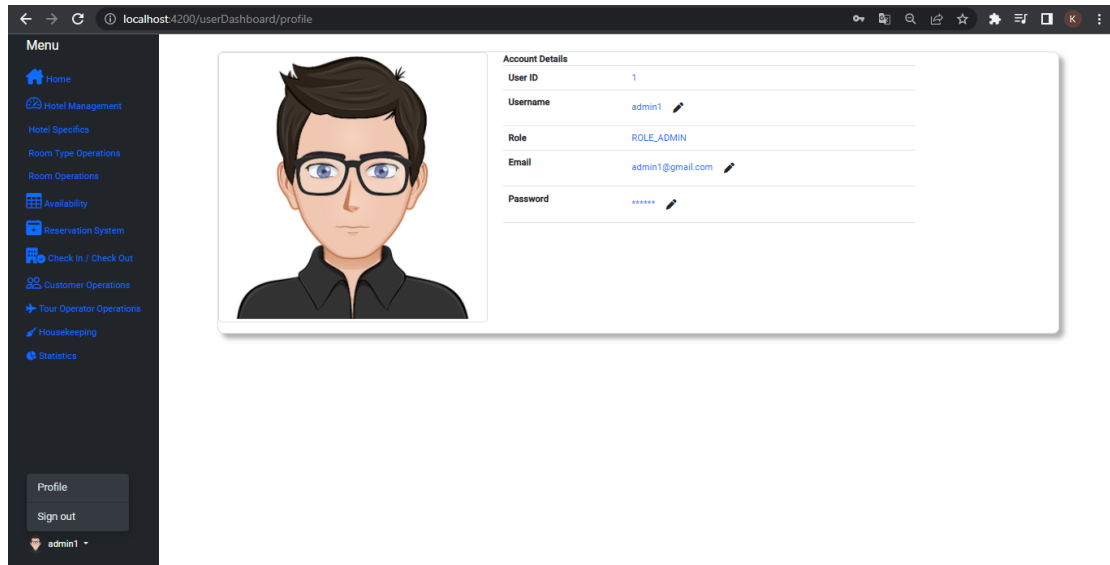

Figure 75 User Profile

5 Customized Web Service

In this section, the customized web service support provided for the communication and sale of rooms will be analyzed. More specifically, a communication protocol was created for continuous communication and booking rooms through a booking application. The following endpoints are provided for communication:

1. bookingEngineReservations/getBookingAppAvailability
2. bookingEngineReservations/saveReservation

The first endpoint provides availability and the second accepts and stores the reservations that have been made through the booking application. The above endpoints are public so they can be used by external applications. Calling the first endpoint returns a JSON file of the structure shown in Figure 76 which includes the number of rooms according to their type and their availability per date.

```

4  ▾ [
5  ▾  {
6      "available": 2,
7      "date": "2023-03-21",
8      "roomName": "Room Si",
9      "roomPrice": 70.0,
10     "type": "Si"
11  },
12  ▾  {
13     "available": 2,
14     "date": "2023-03-22",
15     "roomName": "Room Si",
16     "roomPrice": 70.0,
17     "type": "Si"
18  },
19  ▾  {
20     "available": 2,
21     "date": "2023-03-23",
22     "roomName": "Room Si",
23     "roomPrice": 70.0,
24     "type": "Si"
25  },

```

Figure 76 Get Availability Endpoint

The information about room pricing per night is also provided. Calling the second endpoint returns a JSON file of the structure shown in Figure 77 which includes information about reservation such as check-in date, check-out date, reservation status, customer info,

total price, payment status, and information about reservation types such as room type, number of rooms, number of children, number of adults and nutrition plan.

```
▼ BookingAppReservationRequest ⓘ
  ▼ reservation: ReservationRequest
    ▶ checkInDate: Thu Mar 23 2023 02:00:00
    ▶ checkOutDate: Sat Mar 25 2023 02:00:00
    contactPhone: 6999999999
    paymentStatus: false
    reservationName: "John Doe"
    status: "Pending"
    totalPrice: "140"
    tourOperatorName: "bookingApp"
    ▶ [[Prototype]]: Object
  ▼ reservationTypes: Array(1)
    ▼ 0: ReservationTypeRequest
      numberOfAdults: 1
      numberOfChildren: 0
      numberOfRooms: "1"
      roomType: "Si"
      terms: "FullBoard"
```

Figure 77 Save Reservation Endpoint

As shown in Figure 78, the available hotels of the booking application are shown, where the hotel that appears in the list is the hotel that uses the specific PMS. Then, as seen in Figure 79, the user selects a single room for the dates 2023-03-22 to 2023-03-26. All room availability data shown in the image are updated dynamically based on the customized web service.

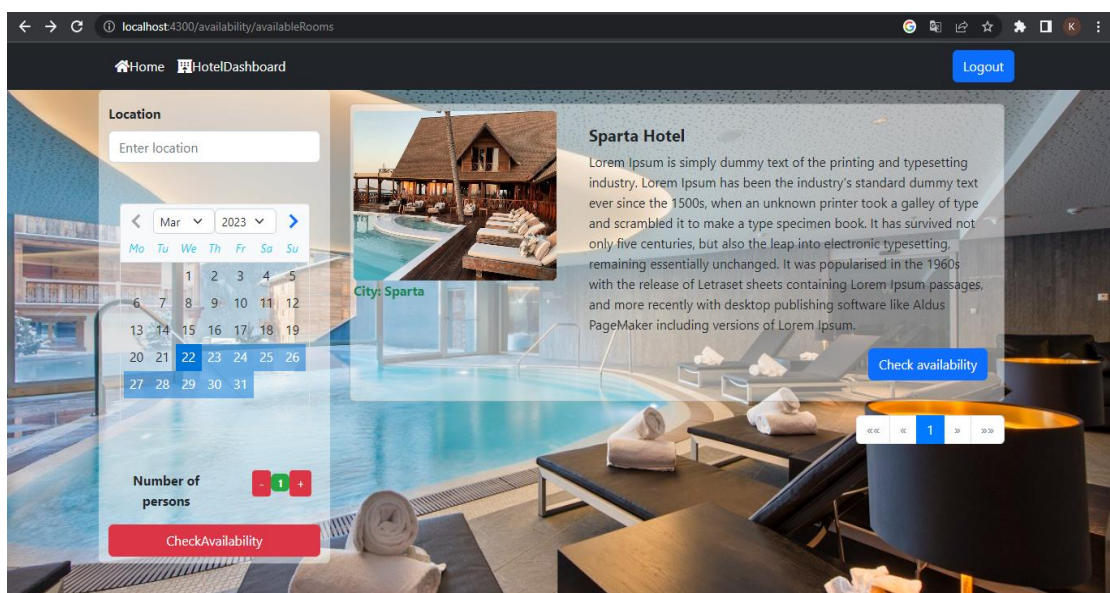

Figure 78 Available Hotels Booking System

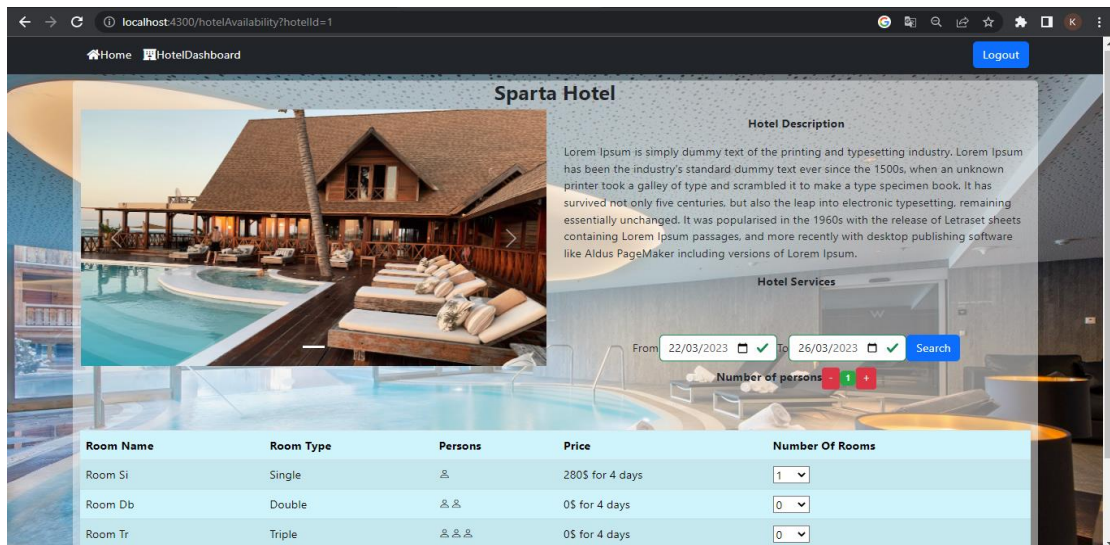

Figure 79 Available Rooms Of Hotel Booking System

Then, in Figure 80 below, the form that the user must fill in with his personal details as well as the payment options can be seen. Finally, Figure 81 shows that the reservation from the side of the booking application was successful.

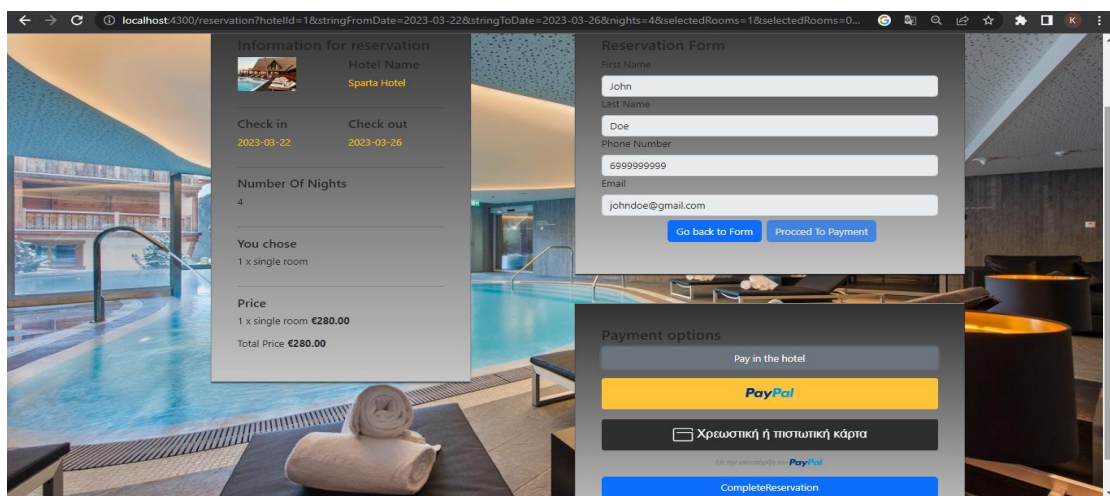

Figure 80 Payment Booking System

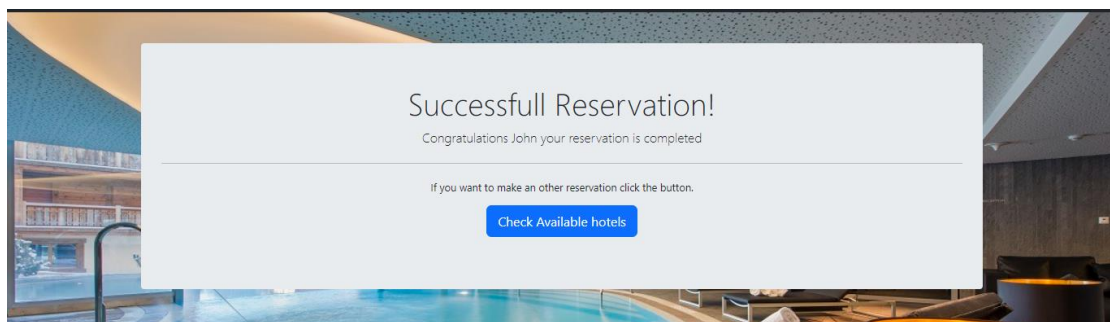

Figure 81 Successful Reservation Booking System

In Figure 81 below, the list of reservations can be seen and it can be observed that the last reservation is the reservation received from the booking application. Finally, Figure 82 illustrates the reservation types of the received reservation.

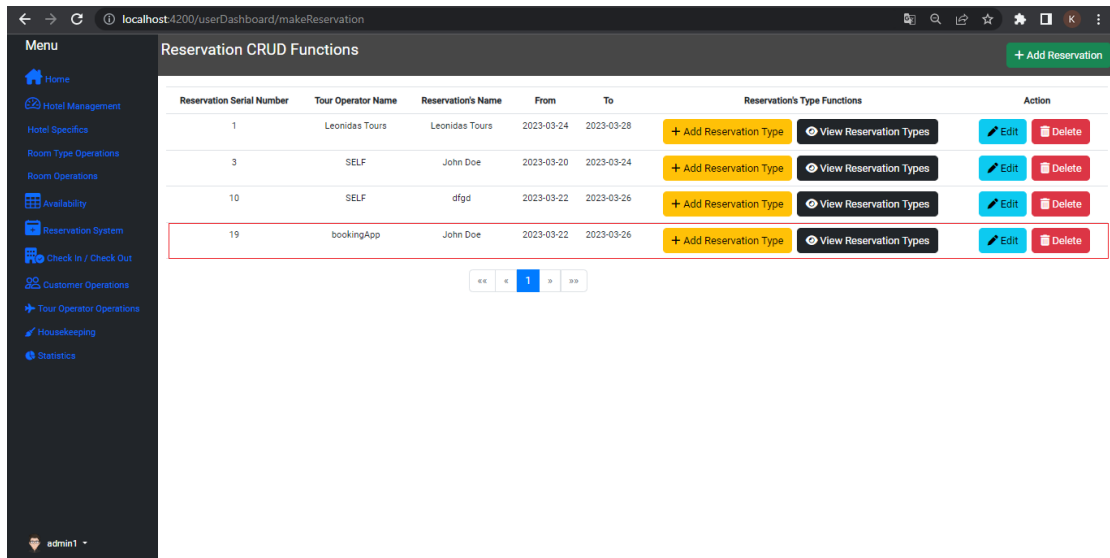

Figure 82 List of Reservations

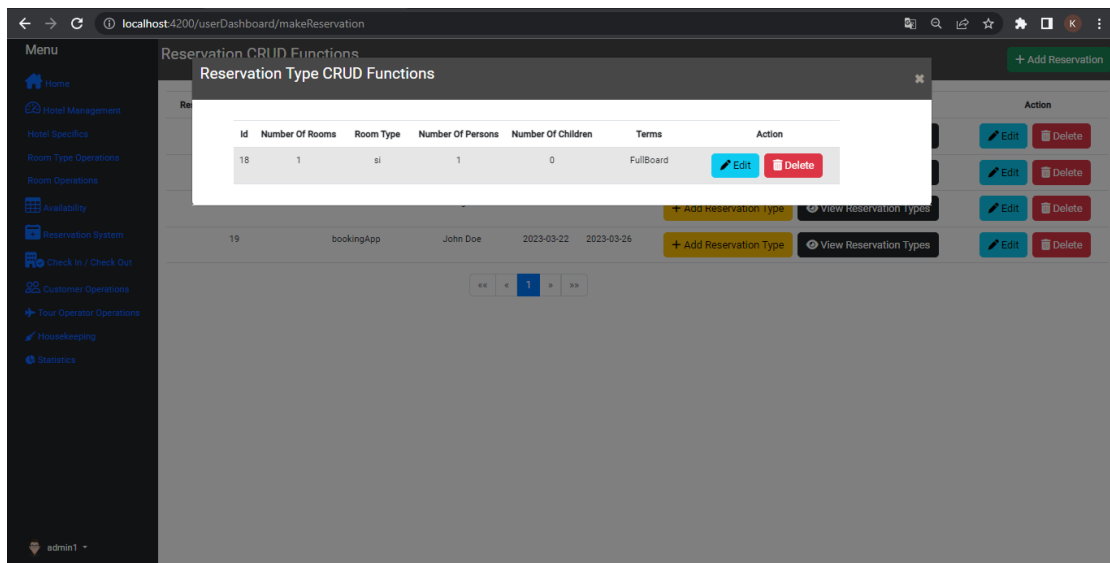

Figure 83 View Reservation Types

Figure 84 below illustrates the communication architecture between the PMS application and the Booking application. More specifically, through the communication protocol that was created, the Booking app can request availability from the PMS through an http GET request. Also, the Booking application makes an http POST request to the PMS application when a new booking is made. With the architecture described above, the communication between the PMS and the Booking App was ensured in real time.

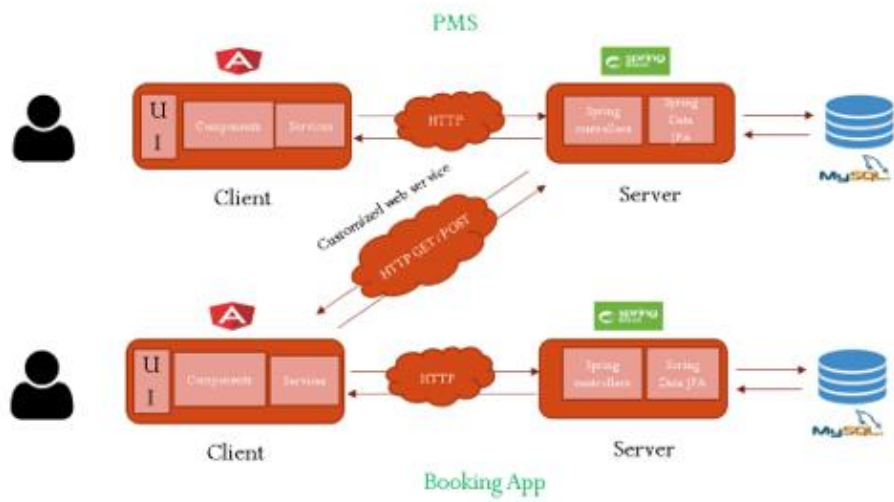

Figure 84 Architecture of customized web service support

6 Conclusion And Future Work

In this section, which is also the last of the work, the results obtained from the development of the PMS which was implemented as part of my master's thesis will be reported. Some functionalities that could be integrated into the PMS in future work will also be mentioned.

6.1 Conclusion

Modern PMS systems can contribute to the maximum in hotel units and the hotel industry in general either by acquiring a personal PMS that will provide special features or by using an already existing PMS service. Both options are sure to provide both easier hotel management and increased revenue.

The implementation of this work is not something completely original, but nevertheless, it provides some special features that could be useful in hotel units. The development of the PMS system, which was implemented as part of my master's thesis, offered me a lot of useful knowledge since I dealt with full stack development and of course, this was a wonderful experience.

Apart from making it simpler for hotel staff to carry out and manage their everyday tasks, the PMS implemented in this work also offers a communication protocol that can be used to interact with booking engines to book rooms and boost a hotel's revenue. Another advantage, as mentioned above in the work, is that the project is open source and anyone can use it or even modify it as they wish.

6.2 Future Work

The improvement of online applications and in general all systems is a need that is constantly increasing. To put it differently, the process of improving and adding new features never ends. Therefore, the same applies to the specific project where there are certainly important additions that could be incorporated as future work. The following are some additions for future work:

- Upgrading the user interface to make the application more user-friendly.
- Assignment of tasks to specific persons of the hotel staff.
- Adding a price list of extra hotel services.
- Integration - communication with popular accounting applications.
- Addition of more features per user role.

- Extension for the database to automatically create a new schema when a new hotel is registered.

References

- [1] Naik, Umesha & Shivalingaiah, D. (2009), Comparative Study of Web 1.0, Web 2.0 and Web 3.0. 10.13140/2.1.2287.2961, pp. 2-6.
- [2] Kuuskeri, Janne. (2011), Experiences on a design approach for interactive web applications. 8-8, p. 1.
- [3] Moyeenudin, H.M. & Shaik, Javed & R, Anandan & Narayanan, Kumar. (2018), Data management with PMS in hotel industry. International Journal of Engineering & Technology. 7. 327. 10.14419/ijet.v7i2.21.12396, pp. 1-3.
- [4] Krželj-Čolović, Z. i Cerović, Z. (2013), IMPLEMENTATION OF PROPERTY MANAGEMENT SYSTEM IN HOTEL INDUSTRY. DIEM, 1 (1), 0-0. Preuzeto s <https://hrcak.srce.hr/161530> , p. 2-7.
- [5] Duhovnaya L., Holodtsova I. (2015), Innovative technologies in hotel businesses, DOI: 10.12737/7478, pp. 1-3.
- [6] Bashynska I. et al. (2019), Sales tunnels in messengers as new technologies for effective Internet-marketing in tourism and hospitality, International Journal of Innovative Technology and Exploring Engineering, Volume-8 Issue-12, pp. 594-598. DOI: 10.35940/ijitee.L3470.1081219.
- [7] Prokopenko O. et al. (2019), Digital-toolkit for promoting tourist destinations, International Journal of Innovative Technology and Exploring Engineering, 8(12), pp. 4982-4987. DOI:10.35940/ijitee.L3745.1081219.
- [8] Trusova N. (2016), Systemic factors of projected financial potential of business entities, Economic Annals-XXI, 161(9-10), pp. 61-65.
- [9] Stergiou and Farmaki, (2021), Ability and willingness to work during COVID-19 pandemic: perspectives of front-line hotel employees, pp. 1-2.
- [10] Belias, Dimitrios & Papademetriou, Christos & Rossidis, Ioannis & Vasiliadis, Labros. (2020), Strategic Management in the Hotel Industry: Proposed Strategic Practices to Recover from COVID-19 Global Crisis. Academic Journal of Interdisciplinary Studies. 9. pp. 130 - 138. 10.36941/ajis-2020-0117.
- [11] Gülmez, Mustafa & Ajanovic, Edina & Karayun, Ismail. (2015), CLOUD-BASED VS DESKTOP-BASED PROPERTY MANAGEMENT SYSTEMS IN HOTEL. The USV Annals of Economics and Public Administration. 15. pp. 160-168.

- [12] Law, R., Leung, D., Au, N., & Lee, H. "Andy." (2013), Progress and Development of Information Technology in the Hospitality Industry: Evidence from Cornell Hospitality Quarterly. *Cornell Hospitality Quarterly*, 54(1), pp. 10–24. <https://doi.org/10.1177/1938965512453199>.
- [13] Law, R., Buhalis, D. and Cobanoglu, C. (2014), "Progress on information and communication technologies in hospitality and tourism", *International Journal of Contemporary Hospitality Management*, Vol. 26 No. 5, pp. 727-750. <https://doi.org/10.1108/IJCHM-08-2013-0367>.
- [14] Ruiz-Molina, ME., Gil-Saura, I. & Moliner-Velázquez, B. (2011), Does technology make a difference? Evidence from Spanish hotels. *Serv Bus* 5, pp. 1–12 <https://doi.org/10.1007/s11628-010-0098-y>.
- [15] Law, R. and Jogaratnam, G. (2005), "A study of hotel information technology applications", *International Journal of Contemporary Hospitality Management*, Vol. 17 No. 2, pp. 170-180. <https://doi.org/10.1108/09596110510582369>.
- [16] Williams, B. K., Sawyer, S. C., & Hutchinson, S. E. (1999), *Using information technology*. Boston: Irwin/McGraw-Hill, pp 1-3.
- [17] Olifer, N., & Olifer, V. (2006), *Computer networks: Principles, technologies and protocol for network design*. West Sussex: John Wiley and Sons.
- [18] Mohod, Niteen. (2020). *Application Of Ict In Research*, p.1.
- [19] Ham, S., Kim, W.G., & Jeong, S. (2005), Effect of information technology on performance in upscale hotels. *International Journal of Hospitality Management*, 24(2), pp. 281-294. doi:10.1016/J.IJHM.2004.06.01. Hayley, T. (2016), Square confirms, people do not like those chip credit cards.
- [20] Abir, Tanvir & Khan, Md Yusuf. (2022), Importance of ICT Advancement and Culture of Adaptation in the Tourism and Hospitality Industry for Developing Countries. 10.4018/978-1-7998-8165-0.ch003, pp. 33-36.
- [21] Makiwa, J. (2018), Developing and validating an ICT adoption framework for SMES in developing countries: A case of Zimbabwe. *Management Journal*, 17(1), pp. 7–28.
- [22] Hughes, K., & Moscardo, G. (2019), ICT and the future of tourist management. *Journal of Tourism Futures*, 5(3), pp. 228–240. doi:10.1108/JTF-12-2018-0072.

- [23] Kazandzhieva, Velina & Santana, Hristina & Prof, Assoc. (2019). E-tourism: Definition, development and conceptual framework, p. 332.
- [24] Condratov, I. (2013). E-Tourism: Concept and Evolution. *EcoForum*, 2(1), pp. 58-61.
- [25] Șoavă, G. & Bădică, A. (2008). Electronic tourism. *Annals of University of Craiova - Economic Sciences Series*, 2(36), pp. 657-662.
- [26] Buhalis, D. (2003). *eTourism: Information Technology for Strategic Tourism Management*. London: Pearson (FT/Prentice Hall).
- [27] Lee, H., Guillet D. & Law, R. (2013). An examination of the relationship between online travel agents and hotels a case study of choice hotels international and Expedia.com. *Cornell Hospitality Quarterly*, 54(1), pp. 95-107.
- [28] Fountoulaki, P., Leue, M. & Jung, T. (2015). Distribution Channels for Travel and Tourism: The Case of Crete. In L. Tussyadiah & A. Inversini (eds.), *Information and Communication Technologies in Tourism, Proceedings of the International Conference in Lugano, Switzerland, February 3 - 6, 2015*, Springer, pp. 667-680.
- [29] Kasavana, M.L. & Cahill, J.J. (2003), *Managing Technology in the Hospitality Industry*, Educational Institute, Lansing, MI, USA, p. 9.
- [30] Bardi, James A. *Hotel Front Office Management*, 3rd Edition. (1970), pp. 97-102.
- [31] Verma, Vaibhav & Thakur, Sheetal. (2020), *Information and Communication Technological Amenities in the Hotel Industry*. *Test Engineering and Management*. 83. pp. 647-658.
- [32] Kimes, S. The evolution of hotel revenue management. *J Revenue Pricing Manag* 15, (2016), <https://doi.org/10.1057/rpm.2016.27>, pp. 247–251.
- [33] Kokaz, Karolin & Murphy, Hilary & Murphy, Catherine. (2011), An investigation of data management and property management systems in hotels. *Tourism and Hospitality Management*. 17. 10.20867/thm.11.1.8, pp. 101-114.
- [34] López-Ruiz, Denisse Ileana; Baeza-Gazca, Emiliano; Cantú-Flores, Katia María; Webber-Garza, Paulina; Arrambide-Leal, Eduardo Javier; et al. (2019), *Diagnosis of information systems for the hotel sector at PuertoMorelos*, pp. 1469-1474.
- [35] Sultan, N. (2010), *Cloud computing for education: a new dawn?*. *International Journal of Information Management*, 30, pp. 109-16.

- [36] Šimunić, Maja & Pilepić Stifanich, Ljubica & Perišić Prodan, Marina. (2018), THE LEVEL OF HOTEL RESERVATION SYNCHRONIZATION PROCESSES USING INFORMATION TECHNOLOGY TOOLS, pp. 4-6.
- [37] Koh, Wei Shun, and Yana Mazwin Mohmad Hassim. 2021, "Hotel Reservation Management System". *Applied Information Technology And Computer Science* 2 (2): pp. 973-92. <https://publisher.uthm.edu.my/periodicals/index.php/aitcs/article/view/5047>.
- [38] Darmowinoto, S. ., Hossain, S. R. ., & Astuti, P. (2022), Development of COVID-19 Isolation Facility Management System with Scrum Framework. *Green Intelligent Systems and Applications*, 2(2),<https://doi.org/10.53623/gisa.v2i2.111>, pp. 96–107.
- [39] REGAINING REPUTATION: AUCKLAND LUXURY HOTELS A STAKEHOLDERS' PERSPECTIVES, <https://doi.org/10.34074/rere.00110>, p. 111.
- [40] Adeyinka-Ojo, S., Lee, S., Abdullah, S.K. and Teo, J. (2020), "Hospitality and tourism education in an emerging digital economy", *Worldwide Hospitality and Tourism Themes*, Vol. 12 No. 2, pp. 113-125. <https://doi.org/10.1108/WHATT-12-2019-0075>
- [41] S., Priyadharshini & Joy, R.Catherine. (2021). Design and Implementation of an Automated Hotel Management System. *International Journal of Engineering and Advanced Technology*. 10. pp. 37-42. 10.35940/ijeat.E2569.0610521.
- [42] Koc, Hatice & Erdoğan, Ali & Barjakly, Yousef & Peker, Serhat. (2021). UML Diagrams in Software Engineering Research: A Systematic Literature Review. *Proceedings*. 74. 13. 10.3390/proceedings2021074013, p. 3.
- [43] Tiwari, Raj & Srivastava, Arun & Bhardwaj, Garima & Kumar, Vinay. (2021). Exploiting UML Diagrams for Test Case Generation: A Review. pp. 457-460. 10.1109/ICIEM51511.2021.9445383.
- [44] Chiang, Roger & Barron, Terence & Storey, Veda. (1994). Reverse engineering of relational databases: Extraction of an EER model from a relational database. *Data & Knowledge Engineering*. 12. 107-142. 10.1016/0169-023X(94)90011-6, p. 114.
- [45] L.Ruebbelke, *AngularJS In Action*. (2015), pp 4-5.
- [46] C. Walls, *Spring Boot in Action*. (2016), pp. 1-4.
- [47] Ohuver, Margaretha & Moniaga, Jurike & Sungkawa, Iwa & Subagyo, Bonifasius & Chandra, Ian. (2019). The Comparison Firebase Realtime Database and MySQL Database

Performance using Wilcoxon Signed-Rank Test. *Procedia Computer Science*. 157. pp. 396-405. [10.1016/j.procs.2019.08.231](https://doi.org/10.1016/j.procs.2019.08.231).