

EXPOSURE EMF MEASUREMENTS WITH SPECTRUM ANALYZER USING FREE AND
OPEN SOURCE SOFTWARE

by

BORMPANTONAKIS PROKOPIOS

Electrical Engineer, Technological Institute of Crete, 2013

A THESIS

submitted in partial fulfillment of the requirements for the degree

MASTER OF SCIENCE

DEPARTMENT OF INFORMATICS ENGINEERING

SCHOOL OF APPLIED TECHNOLOGY

TECHNOLOGICAL EDUCATIONAL INSTITUTE OF CRETE

2017

Approved by:

Major Professor
Dr. Stratakis Dimitrios

Copyright

BORMPANTONAKIS PROKOPIOS

2017

This work is licensed under the Creative Commons Attribution-Non Commercial-Share Alike 4.0 International License. To view a copy of this license, visit <http://creativecommons.org/licenses/by-nc-sa/4.0/>

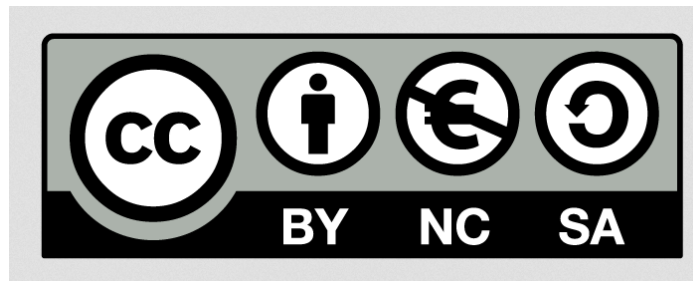

Abstract

The modern lifestyle combined with the growing need of people for fast, immediate and reliable communication, have led to the evolution of wireless communications. At the same time, public concerns about potential adverse effects of exposure to Electromagnetic Fields (EMF) have also been increased. This is one of the main reasons that proper and reliable measurements of EMF in wireless communications are an important object of study by scientists. These measurements should be performed based on existing measurement protocols and comply with the Greek Legislation and other national and international recommendations and standards. The process of EMF exposure measurements is a difficult and complicated procedure, because different instrument settings for each particular frequency area are required. Moreover, the mathematical computations for calculating the necessary quantities and comparing them with the existing limits, is a time-consuming process. By automating both the procedure of taking measurements and the post processing of the measurement data, the measurement process is simplified and can be significantly accelerated. This can highly contribute to its effectiveness and reliability.

The aim of this Master Thesis is the design and develop of special purpose open source software, which in operation with Spectrum Analyzers will fully automates the electromagnetic radiation measurement procedures at multiple frequency fields such as UMTS, GSM, Wi-Fi, TETRA, etc. The software will contain default settings adapted to these frequency fields. Furthermore, it will provide to the user the ability to customize the measurement settings according to his personal requirements. In addition, selection of different types of antennas, cables and spectrum analyzer models which adopt the SCPI standard will be allowed and new elements will be possible to be imported with a simple update. Also, storage of measurement data for their further processing and comparison with the protection limits will be enabled. Furthermore, a relevant report with the results and conclusions of the measurements will be generated. Finally, real measurements will follow, with the use of the existing equipment of the "Non-Ionizing Radiation Laboratory of TEI of Crete" (spectrum analyzer and appropriate antennas) in combination with the developed open source software.

Table of Contents

Copyright	ii
Abstract	iii
Table of Contents	iv
List of Figures	vii
List of Tables	ix
Acknowledgements.....	x
Dedication.....	xi
Preface.....	xii
Chapter 1 - EMF, Electromagnetic Radiation and Spectrum	1
1.1 Electromagnetic Radiation and Electromagnetic Spectrum	1
1.2 Radio Frequency Spectrum.....	3
1.2.1 FM Band	3
1.2.2 Analog TV	3
1.2.3 Digital TV	4
1.2.4 Terrestrial Trunked Radio (TETRA)	5
1.2.5 GSM Systems.....	6
1.2.6 UMTS	7
1.2.7 Wireless Fidelity (Wi-Fi).....	9
Chapter 2 - EMF Exposure, Potential health effects, Protection limits	11
2.1 Exposure to EMF in different wireless communication technologies	11
2.1.1 Thermal Effects.....	12
2.1.2 Non - Thermal Effects.....	13
2.1.3 Serious health issues reported and possible association with EMF	14
2.1.4 Epidemiological studies	14
2.2 EMF Exposure Guidelines and established Safety Limits.....	15
2.2.1 ICNIRP Guidelines	16
2.2.2 Basic Restrictions and Reference Levels	16
2.2.3 European and Greek Legislation for General Public EMF Exposure	17

2.2.4 Exposure to multiple frequencies Electromagnetic Fields.....	21
Chapter 3 - EMF exposure measurements methodology.....	25
3.1 General remarks.....	25
3.2 Broadband and narrowband measurements.....	25
3.2 Spectrum Analyzer fundamentals.....	26
3.3 Methodology of measurements.....	34
3.4 Mathematical analysis of EMF exposure measurements.....	36
3.5 Uncertainty of measurements.....	41
3.5.1 General Remarks.....	41
3.5.2 Evaluation of uncertainty components.....	42
3.5.3 Estimation of uncertainty using spectrum analyzer.....	44
Chapter 4 - Software Implementation.....	45
4.1 General Remarks.....	45
4.2 Free and Open Source Software Terms and Licenses.....	45
4.2.1 Free and Open Source Software benefits and advantages.....	45
4.2.2 Free and Open Source Software Licenses.....	46
4.3 Ubuntu open source software.....	47
4.4 Ubuntu open source software installation.....	48
4.5 Python programming language and Spyder IDE environment.....	51
4.6 Virtual Instrument Implementation Standard (VISA).....	53
4.7 Standard Commands for Programmable Instruments (SCPI).....	55
4.8 PyQt Graphical User Interface widget tool.....	56
4.9 Software applications for automating EMF measurements.....	59
Chapter 5 - Software Presentation.....	61
5.1 General Remarks.....	61
5.2 Antenna and Cables selection.....	62
5.3 Connection with the Spectrum Analyzer.....	63
5.4 Perform measurements with default parameters.....	65
5.5 Change default parameters for any frequency band.....	69
5.6 User defined measurements.....	70
5.7 Storage of measurement captured data.....	73

5.8 Measurement analysis and comparison with the exposure limits	74
5.9 Generate the report of the measurement	75
5.10 Modification of Antenna and Cable's data	76
5.11 Computation of Antenna Factor and Cable's Attenuation.....	78
5.12 Insert spectrum analyzer	80
Chapter 6 - Using presented software to perform measurements	82
6.1 Connection of measurement equipment and software	82
6.2 Perform measurements with predefined settings	84
6.3 Evaluation of the EMF exposure	85
6.3 Results of the measurement	87
6.3.1 Results of FM band measurement.....	87
6.3.2 Results of TETRA-TV band measurement.....	88
6.3.3 Results of GSM900 band measurement.....	90
6.3.4 Results of DCS1800 band measurement.....	91
6.3.5 Results of UMTS band measurement	92
6.3.6 Results of Wi-Fi band measurement.....	94
6.3.7 Estimate the exposure to EMF of measurement in multi-band field	97
Chapter 7 - Conclusions and Future Work	99
References.....	101

List of Figures

Figure 1.1 The Electromagnetic Spectrum	2
Figure 1.2 Wi-Fi Channel Diagram	10
Figure 1.3 Brief overview of 802.11 Standards	10
Figure 2.1, 2.2 General public exposure EC and Greek reference levels of E and S_{eq}	20
Figure 2.3, 2.4 General public exposure EC and Greek reference levels of B and H	20
Figure 3.1 Relation between time and frequency domain	27
Figure 3.2 Block diagram of a traditional swept-tuned spectrum analyzer.	28
Figure 3.3 SNR related to RBW	31
Figure 3.4 Envelop Detector	31
Figure 3.5 Signal with two different Video bandwidth filter setting	32
Figure 3.6 Example of Positive peak, Negative peak and Sample Detectors	34
Figure 4.1 Version 14.04 LTS of Ubuntu operating system software	48
Figure 4.2 Ubuntu LTS 14.04 Installation type selection menu	49
Figure 4.3 Create partition for Ubuntu	50
Figure 4.4 Develop of the application in Spyder IDE environment	52
Figure 4.5 Instrument connection using Python and PyVISA-py.....	54
Figure 4.6 Tree format of SCPI commands for measuring instruments voltage and current	55
Figure 4.7 Source code for simple window creation by using Python and PyQt4	57
Figure 4.8 Source code for a file dialog that load its file contents by using Python & PyQt4	58
Figure 4.9 Result of “figure 4.8” source code	59
Figure 5.1 Main Screen of the presented application in Ubuntu environment	61
Figure 5.2 Antenna and Cable(s) selection field.....	62
Figure 5.3 Instrument Connection Window.....	63
Figure 5.4 Python code for SA and antenna rotator connection using PyVisa.....	64
Figure 5.5 Information of spectrum analyzer and the antenna rotator connection result	65
Figure 5.6 Frequency Bands Selection	66
Figure 5.7 Measurement data at FM frequency saved on ods spreadsheet file	68
Figure 5.8 Change Default Parameters Mode Window	70
Figure 5.9 User defined measurements menu.....	72

Figure 5.10 Chart of Power Density vs Frequency on FM band measurement	75
Figure 5.11 Modify cable(s) data window	77
Figure 5.12 PCD8250 Antenna Factor Chart.....	79
Figure 5.13 ARC Both Cables Attenuation Chart	79
Figure 5.14 Insert spectrum analyzer data process	80
Figure 6.1 Chart of NIRL equipment connection for performing measurements.....	82
Figure 6.2, 6.3 The instrumentation of NIRL that used for the EMF measurement process.....	83
Figure 6.4 Instrument connection window	84
Figure 6.5 Select and Compare data window – Analyze data procedure	85
Figure 6.6 Chart of Frequency vs Electric Field Strength as generated by plot function	86
Figure 6.7, 6.8, 6.9 Screenshot from SA during the FM Band EMF measurement process.....	87
Figure 6.10, 6.11, Generated charts of S_{total} and E_{total} at FM band	88
Figure 6.12, 6.13, 6.14 Screenshot from SA during the TETRA-TV Band measurement.....	89
Figure 6.15, 6.16, Generated charts of S_{total} and E_{total} at TETRA-TV band.....	89
Figure 6.17, 6.18, 6.19 Screenshot from SA during the GSM900 Band EMF measurement process.....	90
Figure 6.20, 6.21, Generated charts of S_{total} and E_{total} at GSM900 band.....	90
Figure 6.22, 6.23, 6.24 Screenshot from SA during the DCS1800 Band measurement.....	91
Figure 6.25, 6.26, Generated charts of S_{total} and E_{total} at DCS1800 band	92
Figure 6.27, 6.28, 6.29 Screenshot from SA during the UMTS Band measurement process	93
Figure 6.30, 6.31, Generated charts of S_{total} and E_{total} at UMTS band	93
Figure 6.32, 6.33, 6.34 Screenshot from SA during the Wi-Fi Band measurement process	94
Figure 6.35, 6.36, Generated charts of S_{total} and E_{total} at Wi-Fi band.....	95
Figure 6.37, 6.38, 6.39 Screenshot from SA during the Wi-Fi Band measurement process	96
Figure 6.40, 6.41, Generated charts of S_{total} and E_{total} at Wi-Fi band.....	96

List of Tables

Table 1.1 Frequencies occupied by the channels of analog TV	4
Table 1.2 Technical parameters of DVB-T standard	4
Table 1.3 Technical parameters of TETRA	6
Table 1.4 GSM900 and DCS1800 parameters.....	7
Table 1.5 UMTS WCDMA basic parameters.....	8
Table 4.1 Software for automating EMF measurement comparison	59
Table 6.1 Brief calculated measurement results for FM band	88
Table 6.2 Brief calculated measurement results for TETRA-TV band	89
Table 6.3 Brief calculated measurement results for GSM900 band	91
Table 6.4 Brief calculated measurement results for DCS1800 band	92
Table 6.5 Brief calculated measurement results for UMTS band.....	93
Table 6.6 Brief calculated measurement results for Wi-Fi band	95
Table 6.7 Brief calculated measurement results for Wi-Fi band	97
Table 6.8 Brief calculated measurement results for multi-band field.....	97

Acknowledgements

I would like to thank the faculty and administrative staff of the Department of Informatics Engineering of Technological Educational Institute of Heraklion, for their assistance during the postgraduate program “Informatics and Multimedia”. I would specifically like to thank my thesis supervisor, Dr. Dimitrios Stratakis for his valuable guidance and advice and the thesis committee members Dr. Evangelos Pallis and Dr. Georgios Mastorakis for their valuable input and assistance.

Dedication

This thesis work is dedicated to my wife Kallia, for her encouragement, patience and full support throughout the completion of this Master of Science degree and also to our 16 months son Michalis, who was born during my postgraduate studies, for the joy and happiness he brought to us. I am truly thankful for having you in my life.

Preface

Exposure to electromagnetic fields is not a new phenomenon. However, due to the growth of wireless communications and their frequent use by people, exposure to electromagnetic fields has also been increased. This leads to public concerns about potential adverse effects on human health. That's why, exposure to electromagnetic fields should be performed. To be scientifically correct, these measurements must comply with the national and international recommendations and standards. Because measuring exposure to electromagnetic radiation is a very complex and time consuming method, various software for automating this process have been created. These applications are mainly developed in closed-source and commercial software which provide, among others, customized libraries, simplicity and friendly user interface. Nevertheless, they are usually quite expensive both to purchase and for getting their upgrades, without giving the ability to the user to control the process of carrying out and processing the measurements. Conversely, the use of open source software enables the user to fully control the measurement process, confirming in this way the correct and reliable operation. Moreover, open source software unlike commercial software is available free and essentially without any cost. However, the implementation of open source software similarly with commercial software consist a complicated process, since it requires the correct choice for type and versions among various programming languages, libraries, and modules that will be used in order to collaborate in harmony. Therefore, the design and develop of a corresponding application, exclusively using open and free software tools, providing graphical user interface, usability, reliability and also convenience for upgrading, could be a particular challenge.

By accepting this challenge, we have created an application that performs electromagnetic radiation measurements and has been developed entirely in open source and free software. This application estimates the exposure to electromagnetic radiation, taking into account the established limits of the responsible organizations while providing the ability of easily upgrading by the operator, for the use of additional measurement instruments except of predefined.

In the first Chapter, the concepts of the electromagnetic spectrum, electromagnetic radiation and electromagnetic fields in wireless communications are presented. In addition, a

brief analysis of basic elements and characteristics of the frequency bands used in wireless communications and can be measured by the particular software in this thesis is provided. In Chapter Two, reference is made to the reasons and the consequences of human exposure to electromagnetic radiation and respectively limits as established by the Greek Legislation and other international recommendations and standards are presented. Chapter Three includes significant information for operations and functions of spectrum analyzer and other measurement equipment. Furthermore, a reference is made to the methodology performed on electromagnetic radiation measurements and also to mathematical analysis for calculating and evaluating the overall result of EMF exposure. Chapter Four is mentioned to the terms of open source and free software, and licenses that are govern them as well as to software and libraries in which the program has been based and developed. In Chapter Five, functions, options and features that the software provides are presented. Chapter Six presents real EMF exposure measurements that have been taken, and also provides the post processing of their data and calculation of the overall result of EMF exposure using the software presented in this thesis. Finally, the last Chapter is mentioned on conclusions of this thesis along with thoughts for future work in the specific area.

Chapter 1 - EMF, Electromagnetic Radiation and Spectrum

EMF is short for electromagnetic fields or sometimes known as electromagnetic radiation (EMR) or electromagnetic energy (EME). EMF is present everywhere in our environment. Although most electromagnetic fields are invisible, some of them can be visible to the human eye. EMF consists of electromagnetic waves of different frequencies and wavelengths, and is derived from natural or human made sources. Earth's electromagnetic field, sunlight, thunderbolts are natural sources of electromagnetic fields whereas human made sources include household appliances (microwave oven, TV, etc.), electricity transmission lines, television and radio stations, mobile phone base stations, radar and others. To create them, a source with accelerating electric charges and changing currents is needed [1].

1.1 Electromagnetic Radiation and Electromagnetic Spectrum

Electromagnetic waves are vibrations of magnetic and electric fields. Electromagnetic radiation consists of electromagnetic waves that are mostly invisible and propagate at the speed of light through a vacuum or matter. In this radiation only a small portion can be detected by the human eye and that is the visible light which produces the various colors of the rainbow. Other familiar electromagnetic radiations are invisible to the human eye, such as radio waves, infrared light and X-rays.

Electromagnetic radiation extends across a wide range, from below the low frequencies used for modern radio communication to gamma radiation at the short-wavelength (high-frequency). This range is known as the Electromagnetic Spectrum and is mainly comprised of several sub-regions (frequency bands) according to the characteristics of the electromagnetic waves. More specific, these frequency bands are termed as radio waves, microwaves, infrared (IR), visible light, ultraviolet (UV), X-rays and gamma rays. Typically, lower-energy radiation, such as radio waves, is expressed as frequency; microwaves, infrared, visible and UV light are usually expressed as wavelength; and higher-energy radiation, such as X-rays and gamma rays, is expressed in terms of energy per photon [2].

Figure 1.1 The Electromagnetic Spectrum

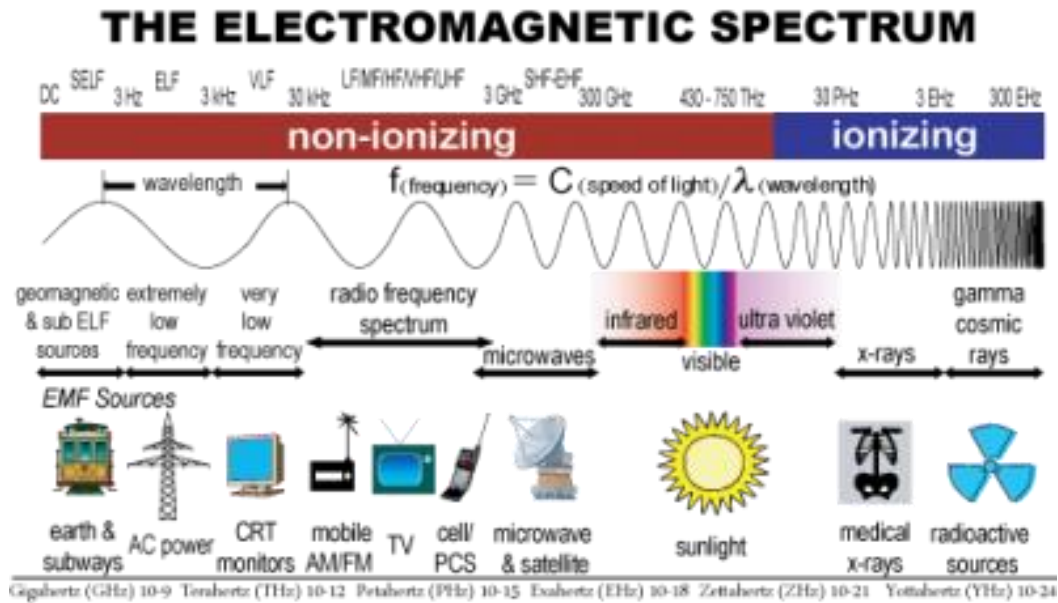

The spectrum can be divided into two categories depends on radiation, the ionizing radiation and the non-ionizing radiation. Ionizing radiation is one that has higher frequency than visible light. It has a smaller wavelength and carries very high energy, enough energy so that during an interaction with atom, can remove tightly bound electrons from the orbit of an atom, causing the atom to become charged or ionized [3]. Displacement of electrons in human tissue can result in considerable adverse effects such as potential case direct or indirect damage on DNA. The most known ionizing radiations are X-rays that are widely used in medicine and radiations a, b, and c that are emitted from unstable atomic nucleus.

On the other hand, non-ionizing radiation (also known as electromagnetic radiation), is the one that carries relatively low energy, does not cause ionization but is able to induce electrical, chemical and thermal effects on the human body. In essence it consists by oscillations of electric and magnetic fields that propagate as waveform in the area. The different types of electromagnetic radiation are distinguished by frequency or the length of propagating wave. Non-ionizing radiation includes electric and magnetic fields, radio waves, microwaves, infrared, ultraviolet, and visible radiation.

1.2 Radio Frequency Spectrum

The Radio Frequency (RF) spectrum consist any electromagnetic wave frequencies that lie in the range extending from below 3KHz to about 300 GHz and that include the frequencies used for communications signals [4]. For wireless communication purposes, radiofrequency fields between a few MHz to some GHz are of particular interest. This range above others, includes adjacent 100 MHz frequency FM radio transmitters, TETRA and Television at around 800 MHz, Mobile Telephony consisting of GSM at 900 MHz, DCS at 1800 MHz and UMTS at 1900 to 2100 MHz. It is also including Wi-Fi which operates at 2.4 GHz.

1.2.1 FM Band

FM broadcasting is radio broadcasting using Frequency Modulation (FM) technology. For FM broadcasting all over the world, VHF part of the radio spectrum and more specific the frequency range of 87.5 to 108.7 MHz is usually used. The frequency band that corresponds to FM broadcasting is termed as FM band. This band is used from Radio Stations. Each Radio Station generates a modulated signal which occupies a small frequency band around the carrier frequency of the station. To avoid interference between radio stations, these signals have a spectral distance between them which is usually 300 Hz.

1.2.2 Analog TV

The Analog TV mostly uses the UHF band for broadcasting but some channels broadcast in VHF Band. Each television signal consists of one carrier for video and one carrier for audio in monaural transmission or two carriers in stereo transmission. Video and audio carriers have 5.5 MHz distance from each other, if the European PAL system is used. In the same coverage area, only alternating channels are possible [5]. Frequencies occupied by the channels of analog TV are presented in table 1.1

Table 1.1 Frequencies occupied by the channels of analog TV

Band	Channels	Frequency
VHF	2, 3, 4	54 MHz – 72 MHz
VHF	5, 6	76 MHz – 88 MHz
VHF	7 – 13	174 MHz – 216 MHz
UHF	14 – 83	470 MHz – 890 MHz

1.2.3 Digital TV

The Digital Video Broadcasting also known as DVB refers to the digital broadcasting of television which is recently replaced the analog broadcasting. Nowadays, there are three different common versions of DVB on digital TV area. The DVB-T is the digital terrestrial television and thus comparable to the old TV antennas on the roofs for analog television and certified in 1999, long after than the DVB-S for satellite broadcasting and DVB-C for Cable TV standards, that both have been certified since 1994. Despite the significant delay in the implementation because its complexity of modulation that DVB-T uses, this particular standard expanded too fast and now implemented in many European countries, including Greece. The following table 1.2 displays the main technical parameters of DVB-T.

Table 1.2 Technical parameters of DVB-T standard

Frequency Bandwidth	174 MHz – 230 MHz 470 MHz – 790 MHz 790 MHz – 862 MHz
Transmission Band	UHF
Polarization	Horizontal or Vertical
Bandwidth	6 MHz – 8 MHz
Channels number	4 per Channel
Power	Until 100 KW (ERP) per Channel

Modulation Type	QPSK / 16QAM / 64QAM – COFDM
Transmission Rates	4.98 Mbps – 31.67 Mbps
Coding	MPEG-2

1.2.4 Terrestrial Trunked Radio (TETRA)

Terrestrial Trunked Radio (TETRA) is a private mobile specification standardized by the European Telecommunications Standards Institute (ETSI) during the 1990's. It was specifically designed for use by government agencies, emergency services, (police forces, fire departments, ambulance) for public safety networks, rail transportation staff for train radios, transport services and military forces [6]. Even though it was originally developed for replacing outdated European analog Professional Mobile Radio (PMR) systems and to stimulate the movement towards the digital era, it is currently adopted as a truly open international digital PMR standard. TETRA uses Time Division Multiple Access (TDMA) with four user channels on one radio carrier and 25 KHz spacing between carriers. Both point-to-point and point-to-multipoint transfer can be used [7]. Mobile Stations of TETRA can communicate each other via direct-mode operation (DMO) or by using trunked-mode operation (TMO). Direct communication when network coverage is not available is also allowed. Operation of Direct Mode offers the option of using a sequence of one or more TETRA terminals as relays.

TETRA has been designed to operate in the 150 MHz to 900 MHz frequency range and for each cell one or more pairs of carriers for uplink and downlink have been allocated. Uplink and downlink are separated with the range of 45 MHz and 10 MHz in UHF and VHF bands respectively. The main parameters of TETRA communication systems are presented in the following table 1.3.

Table 1.3 Technical parameters of TETRA

Frequency	410 MHz – 430 MHz
Bandwidth	450 MHz – 460 MHz / 460 MHz – 470 MHz → for commercial use 870 MHz – 876 MHz / 925 MHz – 931 MHz → for commercial use 380 MHz – 400 MHz → for emergency services
Transmission Band	UHF
Carrier Data Rate	36 Kbps
Voice Coder Rate	ACELP (4.56 Kbps net, 7.52 Kbps gross)
Access Method	TDMA with 4 time slots per carrier
Modulation Type	7.2 Kbps per time slot
Maximum Data Rate	28.8 Kbps
Protected Data Rate	Up to 19.2 Kbps

1.2.5 GSM Systems

The Global system for mobile communication (GSM) is a globally accepted standard for digital cellular communication. GSM is the name of standardization group is the 2nd generation mobile secular system and was created in 1982 to establish a common European mobile telephone standard that would formulate specifications for a pan-European mobile cellular radio system operating at 900 MHz [8]. This cellular telephone system connects mobile subscribers into the public telephone system or to another cellular subscriber, emits at microwave frequencies and includes GSM900 and DCS1800 bands. The service area in which mobile communication is to be provided, is divided into regions called cells. In each cell, an antenna transmits and receives calls from any subscriber that exists into its coverage area.

In GSM900 band, the radio frequency channels (carriers) are numbered from 1 to 124. The corresponding carrier frequency is represented by absolute radio frequency channel number (ARFCN). If $F_{up}(n)$ and $F_{down}(n)$ mean the uplink frequency and downlink frequency with n of ARFCN then

$$\text{Mobile Transmits: } f_{up}(n) = 890.2 + 0.2 \cdot (n - 1) \text{ MHz} \quad (1.1)$$

$$\text{Base Transmits: } f_{down}(n) = f_{up}(n) + 45 \text{ MHz} \quad (1.2)$$

with $1 \leq n \leq 124$

In DCS1800 band, full duplex transmission is supported by using two sub-bands spaced 95 MHz apart. Similar to the primary GSM band, the radio frequency channels for the DCS1800 band are numbered from 512 to 885 and the corresponding frequency can be found from the following equations (1.3), (1.4) [9]. The following table 1.4 presents GSM900 and DCS1800 basic parameters.

$$\text{Mobile Transmits: } f_{up}(n) = 1710.2 + 0.2 \cdot (n - 512) \text{ MHz} \quad (1.3)$$

$$\text{Base Transmits: } f_{down}(n) = f_{up}(n) + 95 \text{ MHz} \quad (1.4)$$

with $512 \leq n \leq 885$

Table 1.4 GSM900 and DCS1800 parameters

Parameters	GSM900	DCS1800
Uplink	890 – 915 MHz	1710 – 1785 MHz
Downlink	935 – 960 MHz	1805 – 1880 MHz
Carrier Spacing	200 KHz (8 users)	200 KHz (8 users)
Total of Carriers	124 carriers	373 carriers
Access Method	TDMA & FDMA	TDMA & FDMA
Modulation	GMSK	GMSK
Bandwidth	25 MHz	75 MHz
Transmit & Receive Separation	45 MHz	95 MHz

1.2.6 UMTS

UMTS is abbreviation of “Universal Mobile Telecommunications System”. This technology is a further development of the second-generation Global System for Mobile (GSM) communication standard. It uses a new transfer procedure for wireless data transfer between a

mobile phone and a base station. It is based on WCDMA (Wideband Code Division Multiple Access) technology and provides among others, a broadband, packet-based service for transmitting video, text, digitized voice. Between UMTS advantages, increased data transmission rates and concurrent support of higher data and voice volumes are distinguished. In particular, UMTS supports maximum theoretical data transfer rates of 42 Mbps when Evolved HSPA (HSPA+) is implemented in the network [10]. Users in deployed networks can expect a transfer rate of up to 384 Kbps for Release '99 (R99) handsets (the original UMTS release), and 7.2 Mbps for High-Speed Downlink Packet Access (HSDPA) handsets in the downlink connection [11].

UMTS currently provides data transfer speeds of 384 Kbps when highly user movement is observed. Conversely, when user remains motionless, transmission rates are greatly increase, reaching a rate of 2 Mbps. For guiding of maintenance and development in this band, the non-governmental organization named as “Third Generation Partnership Project” 3GPP was established.

The main improvement of UMTS compared to GSM was the completely redesigned radio access network, which the UMTS standards refer to as the UMTS Terrestrial Radio Access Network (UTRAN). Instead of using the time- and frequency-multiplexing method of the GSM air interface, a new method called Wideband Code Division Multiple Access (WCDMA) was introduced. In WCDMA, users are no longer separated from each other by timeslots and frequencies but are assigned a unique code [12]. The UMTS WCDMA system offered a significant improvement in capability over the previous 2G services. Main parameters for UMTS WCDMA are presented into the table 1.5 below.

Table 1.5 UMTS WCDMA basic parameters

Data rate	2048 kbps (low range) 384 kbps (urban and outdoor)
RF channel bandwidth	5 MHz
Multiple access scheme	CDMA
Duplex schemes	FDD and TDD

1.2.7 Wireless Fidelity (Wi-Fi)

The Wireless local area networks (WLAN) are growing rapidly, especially in the last few years. The Wireless Fidelity network widely known as Wi-Fi, is a WLAN which is intended to be used in local premises like shops, hotels, institutions, houses etc. The purposes of using WLAN networks are: wireless connection of computers into a network providing mobility of computers [13].

Wireless networking technologies allows computers and other devices to communicating over a wireless signal [14]. The main parts comprising a typical Wi-Fi network are a wired connection to a broadband provider, an access point, and a computer connected by wired and wireless connections. These networks typically work in one of two configurations (sometimes called topologies): ad-hoc or infrastructure. The topology or mode depends on whether end devices communicate directly or with an access point [15]. A large amount of Wi-Fi networks function in infrastructure mode. Devices on the network all communicate through a single access point, which is generally the wireless router. On the other hand, Ad-hoc networks, also known as “peer-to-peer” networks, don’t require a centralized access point. Instead, devices on the wireless network connect directly to each other.

Most important components of WLAN are modulation and spread spectrum technologies. The major WLAN standardization activity is IEEE 802.11. IEEE 802.11 is a standard working group on wireless local area networks. This working group was established in 1990 which has developed among others the well-known and successful protocols 802.11a operate in 5 GHz, 802.11b and 802.11g that operate in 2.4 GHz and in year 2009 the 802.11n that operates on both the 2.4 GHz and the 5 GHz frequency bands and provides a maximum net data rate from 54 Mbit/s to 600 Mbit/s.

The 2.4 GHz band is divided into 14 channels spaced 5 MHz apart, beginning with channel 1, which is centered on 2.412 GHz. The latter channels have additional restrictions or are unavailable for use in some regulatory domains. Speaking for 2.4 frequency band, the 802.11b was based on DSSS modulation and utilized a channel bandwidth of 22 MHz resulting in three “non-overlapping” channels the 1, 6, and 11 (Figure 1.2.1). 802.11g standard was based on

OFDM modulation and utilized a channel bandwidth of 20 MHz. Brief overviews of the 802.11 a/b/g/n standards are presented in the figure 1.2.2.

Figure 1.2 Wi-Fi Channel Diagram

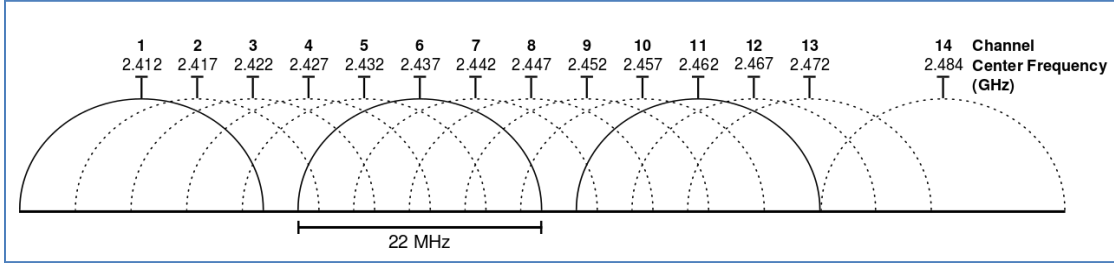

Figure 1.3 Brief overview of 802.11 Standards

Standard name	802.11a	802.11b	802.11g	802.11n
Standardization date	January 2000	December 1999	June 2003	June 2009
Maximum bandwidth	54 Mbps	11 Mbps	54 Mbps	600 Mbps
Modulation technique	OFDM	DSSS, CCK	DSSS, CCK, OFDM	DSSS, CCK, OFDM+
RF band	5 GHz	2.4 GHz	2.4 GHz	2.4 or 5 GHz
Channel bandwidth	20 MHz	20 MHz	20 MHz	20 or 40 MHz

Chapter 2 - EMF Exposure, Potential health effects, Protection limits

Mobile telephony and wireless networks in general, are widespread all over the world. The information broadcast is performed by radio signals using antennas or base stations networks. By passing of this technology in the third and fourth generation, the number of the antennas and base stations have increased significantly. Furthermore, in each country radio and television station antennas are used, whose operation is based on the emission of electromagnetic waves. Moreover, wireless networks which allow connection of the internet devices, are found in homes, in public places and also in workplaces.

2.1 Exposure to EMF in different wireless communication technologies

From the above, we notice that human exposure to electromagnetic fields has increased significantly and is inevitable. People willingly or not, are exposed to electromagnetic fields, whether they are using these communication systems or not. However, EMF belongs to non-ionizing radiation, which in contrast to ionizing radiation such as X-rays or gamma rays, are unable to break chemical bonds or cause ionization of molecules in the human body.

Electric fields are generated by electric charges and are shielded by common materials such as wood and metal. On the other hand, magnetic fields which are not shielded by most common materials and easily are passing through them. Both types of these fields become weaker when removed from their source while they are most powerful when they are near these. Electric fields are measured in Volts per Meter (V/m) and magnetic fields are measured in Tesla (T), usually in mT or μT while in some countries magnetic fields are measured in Gauss (G). 1 G is equal to 10^{-4} Tesla. In the frequency range of 80 MHz to 800 MHz, frequencies of FM radio and TV antennas broadcast, the output power of the antennas is between 10 to 50 KW. These antennas are horizontal or vertical dipole arrays.

The wireless communications technology offers many applications as we saw in the previous chapter. With the rise of exposure to electromagnetic fields, public concerns about possible adverse effects on human health, has also been increased. The human body has the particularity to absorb the electromagnetic radiation. This makes people susceptible in electromagnetic fields. The absorption of the electromagnetic radiation emitted by the wireless communications systems can cause both thermal effects and non-thermal effects in humans.

2.1.1 Thermal Effects

The EMF exposure could produce thermal heating. This practically means that the temperature of the exposed tissue increases, as with the microwave oven, which of course operates with much greater power of electromagnetic radiation. This is because RF absorbed energy is transformed into kinetic energy of molecules. When the human body gets within an electromagnetic field, the water molecules, which are dipoles, will start to rotate or vibrate in wave frequency rate. As the longer the pulse rate and the greater duration of the effect is, the higher amount of heat will be produced. It is worth emphasizing that the heat can be transferred to the environment only after it is first transferred to the surface of the body [16].

Human body has thermoregulatory mechanisms that keep body temperature stable between 36 and 37 degrees of Celsius. These thermoregulatory mechanisms can remove the heat generated by the electromagnetic radiation when radiation is at relatively low levels. In this manner, the human body temperature remains constant at 36 to 37 degrees of Celsius. Conversely, when the amount of heat exceeds a certain threshold, then these mechanisms fail to function properly, resulting in the warming of the tissues or organ of the body over 37 degrees of Celsius. In a more general form, we could say that thermal effects are caused when the deposition temperature is greater than the thermoregulatory capacity of the human body.

The temperature increase inside the biological organisms is performed in two stages. At the beginning, strong penetration of electromagnetic radiation into the human body (local or global) is made. Then, the temperature is increased, provided that for a sufficient amount of time the applied electromagnetic field and the power absorbed per unit of body mass is above a

particular threshold. It has been established that the increase of temperature in the human body, is caused when the power density of electromagnetic radiation to which it is exposed is higher than $1\text{mW}/\text{cm}^2$. The temperature increase may cause human dizziness, weakness, nausea, disorientation, even cataract or increased blood pressure. However, for adverse health effects in human's health occurred from exposure to RF fields, such as cataract and skin burns, power densities above $1000\text{ W}/\text{m}^2$ are needed. Such power density levels can be found in particular high power transmitters such as radars [17]. Typical electromagnetic radiation systems used in everyday human life does not operate at such high-power density levels.

2.1.2 Non - Thermal Effects

In addition to thermal effects, exposure to electromagnetic radiation could cause non-thermal effects, which are more important from biological and medical point of view. These effects usually are presented at frequencies lower than 10 MHz but are possible to be occurred at higher frequencies too. Feature of these effects is that increase of the temperature in the human body tissues is not observed, because they are caused by small amounts of power of some mW/cm^2 . Since the nervous system of the human body works according to the electro impulses, stimulation of cells from exposure to electromagnetic fields is possible to arise. Nevertheless, to reach the point of becoming cell stimulation, quite strong electromagnetic fields are required.

In general, field of the non-thermal effects in tissues of the human body from exposure to non-ionizing radiation has been recently studied. Some scientific experiments have shown that biological effects of non-thermal effects of exposure to RF radiation may exist, but according to scientific evidences, there is no clear proof that exposure to this type of electromagnetic radiation have adverse effects on human health.

2.1.3 Serious health issues reported and possible association with EMF

The potential effects on human health from exposure to electromagnetic fields consists a major subject of study for scientists. The most serious health endpoints that have been reported to be associated with extremely low frequency (ELF) and/or RF include childhood and adult leukemia, childhood and adult brain tumors, and increased risk of the neurodegenerative diseases, Alzheimer's and amyotrophic lateral sclerosis (ALS) [18]. There have also been reports of electromagnetic radiation effects produced from mobile base stations and concern disturbances in sleeping behavior, also known as insomnia phenomenon, changes in cognitive task performance as well as other related cell membranes such as blood–brain barrier, calcium flux through membranes, issues on genotoxic effects as DNA strand breaks etc. Furthermore, promotion of cancer has been discussed and clusters of cancer assigned to local base stations. There is no plausible biological or physical mode of action known for these claimed effects [19].

Most percentage of the electromagnetic radiation emitted by wireless systems technologies such as mobile phones, Wi-Fi etc. absorbed by the skin and thus it does not penetrate into the body. This is because the skin has a high electrical conductivity. The amount of energy per unit of tissue absorbed in a given time is called specific absorption rate (SAR) and is measured in W/Kg units. More particularly the increasing temperature of 1 °C in the tissue, the SAR will reach a value of 4 W/Kg.

2.1.4 Epidemiological studies

Epidemiology is a word derived from Greek words epi, meaning on or upon, demos, meaning people, and logos, meaning study of [20], and defined as the study of the occurrence and distribution of health-related events, states, and processes in specified populations, including the study of the determinants influencing such processes, and the application of this knowledge to control relevant health problems [21].

The method of epidemiology applied in this case in order to systematically study on morbidity and mortality due to frequent exposure to electromagnetic fields. In fact,

Epidemiological studies are case-control studies. This method applies in two categories of population. The first sample relates to people who live in areas with high electromagnetic radiation (e.g. near antenna installations) and the other people who live in pure electromagnetic areas. Sample size is an important consideration because it determines the correct evaluation of the results. The smaller the sample, the less reliable the information, for this reason the samples are usually applied to thousands of people. Finally, comparison of the frequency that diseases occurs to the people of the first sample with the diseases occurs to the people of the second sample is made.

For example, a study on exposure to electromagnetic radiation emitted by radars and cancer, two samples would be compared. One, consist of people who live in an area close to a radar system for a reasonable time, and the other of people who live in an area away from it. The result of the study is expressed as an odds ratio (OR)(2.1) [22] [17]. In this case, the numerator of the ratio expresses the group of people with cancer that has been exposed to EMF field produced from a radar system, and the denominator expresses the group of people that has not been exposed.

$$OR = \frac{\text{Odds of being exposed in cases}}{\text{Odds of being exposude in controls}} \quad (2.1)$$

In the context of research related to exposure to electromagnetic radiation, these studies concern the connection of the electromagnetic radiation with different types of cancer, neurological and psychiatric diseases and also for any potential effects on human reproduction.

2.2 EMF Exposure Guidelines and established Safety Limits

Possible effects of electromagnetic radiation are not concerned the scientific community in recent years only. In contrast, since 1970 the scientists are studying the potential impacts of exposure to non-ionizing radiation on human health and generally on living organisms.

According to World Health Organization (WHO), approximate 25000 articles have been published in biological effects and medical applications of non-ionizing radiation field. Although a public portion believes that further studies should be done, scientific knowledge in this field is more extensive than in most chemicals [23]. Based on studies carried out on this matter, no evidence to confirm with confidence the existence of harmful effects on human health from exposure to low level electromagnetic fields, are arising.

2.2.1 ICNIRP Guidelines

For the above reasons, it was necessary to establish safety limits for the exposure to electromagnetic fields. Thus, International Commission on Non-Ionizing Radiation Protection (ICNIRP) [24], taking into account scientific research and scientific literature on exposure to electromagnetic fields in the frequency range of non-ionizing radiation between 0 and 300Gz, and based on their scientific results in epidemiology, medicine, biology, physics and engineering areas, issued guidelines for establishing acceptable limits of exposure to non-ionizing electromagnetic radiation of both the general population and employees. It should be noted that these limits have been established according to research results of short-term exposure to electromagnetic fields and not from long-term exposure, as scientific literature until now for long-term effects is not considered sufficient for the establishment of quantitative limits.

2.2.2 Basic Restrictions and Reference Levels

Based on the above guidelines the permissible radiation limits are divided into two levels. The first level occurs to the general population while the second level to professional workers employed in areas with electromagnetic radiation. More specifically, based on scientific studies, it was considered that the adverse biological effects either partial-body or whole-body, resulting from thermal ascending variation of the body for 1°C. This has result, energy absorption by human body at a rate of 4 W/Kg averaged over the whole body. At the same time, restrictions for

the maximum local special energy absorption rate of 2W/Kg for the head and trunk, and 4W/Kg for the limbs of the body are specified; in order that areas which appear locally high energy absorption will not exist. These values are time depended and regarding to EMF exposure for 6 minutes.

As a consequence of the above was the establishment of time-varying Basic Restrictions for exposure of people to electromagnetic fields. A safety factor which ranges from 10 to 50 was introduced, in order to take into account the uncertainties that exist with regard to individual sensitivities, environmental conditions and differences in the age and health condition of public. The lower rate of 10 regards to the level of workers because it is considered that the professional employees are aware of how to protect against electromagnetic radiation, and the higher rate of 50 is for the public. Therefore, the maximum energy absorption rate is formed, for employees to 0.4W/Kg, and for the general population to 0.08 W/Kg. The physical quantities used to specify these restrictions are specific energy absorption rate –SAR (W/Kg), current density – J (A/m²), and power density – S (W/m²). Practically, the amounts involved in the Basic Restrictions are not easy to be estimated. Thus, depended on frequency Reference Levels provided as a benchmark for estimating the overrun of Basic Restrictions.

As mentioned above, the values provided by the Basic Restrictions are difficult to perform. Therefore, ICNIRP defined Reference Levels that correspond to quantities which can easily be measured. These levels are provided for practical exposure assessment purposes to determine whether the Basic Restrictions are likely to be exceeded [25]. For that, the quantities electric field strength – E (V/m), magnetic field strength – H (A/m), magnetic flux density – B (T), equivalent plane wave power density – S (W/m²) are used. These values are calculated when exposure measurements on electromagnetic fields carried out, and are compared to respective Reference Levels.

2.2.3 European and Greek Legislation for General Public EMF Exposure

Most recent guidelines from the ICNIRP for the protection of the general public exposed to electromagnetic fields, issued in 1998 and have been adopted by the Commission European de

Normalisation Electrotechnique (CENELEC) and European Council since 1999 [26]. The following Table 2.1 presents Basic Restrictions levels by case, for RMS values and 6 minutes time, at frequency “f”.

Table 2.1 Basic Restrictions for EMF in frequency range 0 Hz to 300 GHz

Frequency	Magnetic Flux Density (mT)	Current Density (mA/m ²)	SAR (Whole Body) (W/Kg)	SAR (Head and Trunk) (W/Kg)	SAR (Limbs) (W/Kg)	Power Density S (W/m ²)
0 Hz	40	-	-	-	-	-
> 0 Hz -1 Hz	-	8	-	-	-	-
1 Hz - 4 Hz	-	8/f	-	-	-	-
4 Hz - 1000 Hz	-	2	-	-	-	-
1 KHz – 100 KHz	-	f/500	-	-	-	-
1 KHz – 100 KHz	-	f/500	0,08	2	4	-
10 MHz – 10GHz	-	-	0,08	2	4	-
10 GHz – 300 GHz	-	-	-	-	-	10

Compliance with the reference level will ensure compliance with the relevant basic restriction. On the other hand, if the values obtained from the measurements are higher than Reference Levels, it does not necessarily mean that the Basic Restrictions have been exceeded. In this case, more detailed analysis is required to determine compliance with the Basic Restrictions. Table 2.2 presents the Reference Levels for general public exposure for EMF in frequency range 0 Hz to 300 GHz for RMS values and 6 minutes time, at frequency “f”.

Table 2.2 Reference Levels for EMF in frequency range 0 Hz to 300 GHz

Frequency	Electric field strength E (V/m)	Magnetic field strength H (A/m)	Magnetic field strength H (A/m)	Equivalent plane wave power density S_{eq} (W/m ²)
0 Hz - 1 Hz	-	$3.2 * 10^4$	$4 * 10^4$	-
1 Hz - 8 Hz	10000	$3.2*10^4/f^2$	$4*10^4/f^2$	-
8 Hz - 25 Hz	10000	$4000/f$	$5000/f$	-
25 Hz – 0.8KHz	$250 / f$	$4/f$	$5/f$	-
0.8 KHz – 3 KHz	$250 / f$	5	6.25	-
3 KHz – 150 KHz	87	5	6.25	-
0.15 MHz – 1 MHz	87	$0.73 / f$	$0.92 / f$	-
1 MHz – 10 MHz	$87 / f^{1/2}$	$0.73 / f$	$0.92 / f$	-
10 MHz – 400 MHz	28	0.073	0.092	2
400 MHz – 2 GHz	$1.375*f^{1/2}$	$0.0037*f^{1/2}$	$0.0046*f^{1/2}$	$f / 200$
2 GHz – 300 GHz	61	0.16	0.20	10

Greek Government in context of establishing safety limits for exposure to electromagnetic fields has issued two national legislative acts relating to the protection of the public from non-ionizing radiation. The first legislative act regards to electromagnetic fields emitted by all kinds of land-based antenna stations and named as Common Ministerial Decision “Protection measures for the exposure of the general public to all land based antenna stations” [27], and the second one concerning the protection of the public from exposure to low frequency electric and magnetic fields and is the Common Ministerial Decision “Protection measures for exposure of the general public to all low frequency electric and magnetic fields emitting devices”

[28]. According to these legislative acts, the protection limits were set in Greece to 80% of the European Recommendation Reference Levels.

More over in 2006 Greek Parliament decided to further reduce the exposure limits with the enactment of the Law 3431 “About Electronic Communications and other orders” [29]. Pursuant to this law, no areas around each antenna that emits electromagnetic radiation where exposure levels exceed 70% of the limits established by ICNIRP and can be accessed by the general population, should be exist. In addition, this law determines the exposure limit to 60% of ICNIRP and European Council Recommendation if such antennas are situated less than 300 meters from the perimeter of building nursery schools, childcare facilities, schools, nursing homes and hospitals. Consequently, the limits applying to Greece are even stricter, compared to those established by the ICNIRP and also adopted by European Council. The following figures 2.1, 2.2, 2.3 and 2.4 presents the general public exposure reference levels in European Union and Greece with blue and red line respectively for the E, S_{eq} , B and H.

Figure 2.1, 2.2 General public exposure EC and Greek reference levels of E and S_{eq}

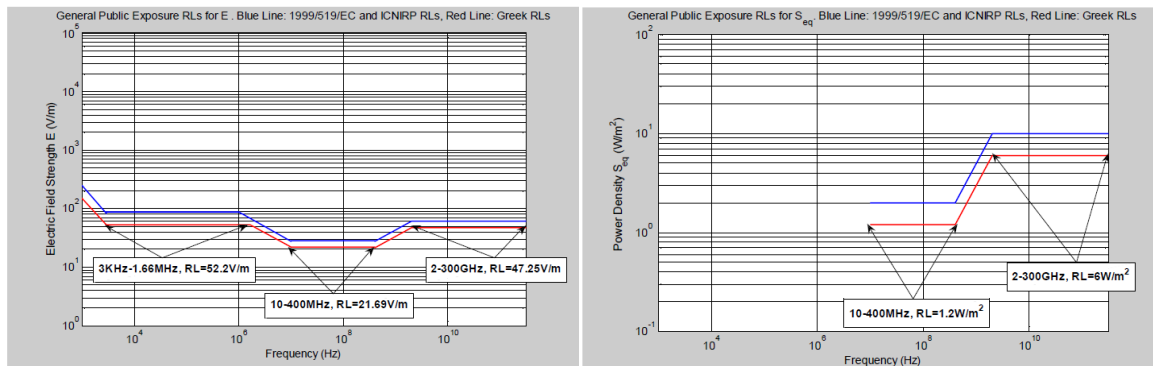
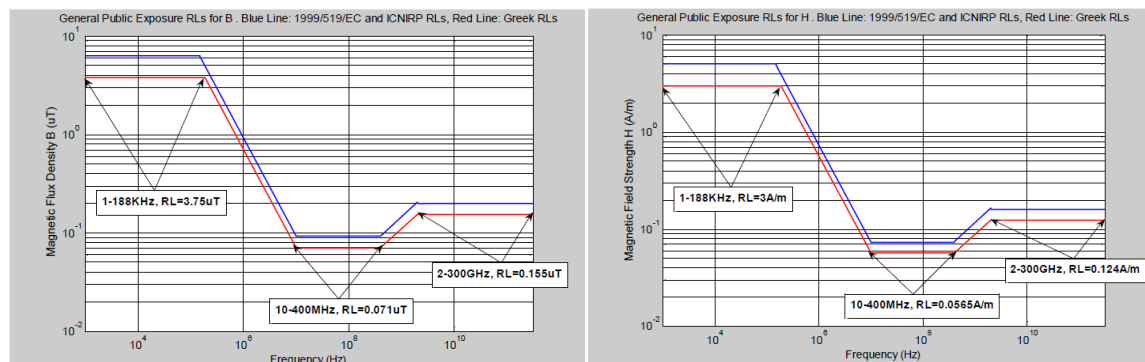

Figure 2.3, 2.4 General public exposure EC and Greek reference levels of B and H



2.2.4 Exposure to multiple frequencies Electromagnetic Fields

If simultaneous exposure to electromagnetic fields of many different frequencies exists, every possibility of incidence should be separately calculated. In other words separate estimates should be made, for both thermal and electrical effects on human health.

As regards electrical effects, they are of interest in the range of frequencies between 1Hz and 10MHz where the current densities, according to ICNRIP guidelines, are calculated using the mathematical formula (2.2). For thermal effects more than 100 kHz, SAR and power density values should be summarized (formula 2.3).

$$\sum_{i=1 \text{ Hz}}^{10 \text{ MHz}} \frac{J_i}{J_{L,i}} \leq 1 \quad (2.2)$$

$$\sum_{i=100 \text{ kHz}}^{10 \text{ GHz}} \frac{SAR_i}{SAR_L} + \sum_{i>10 \text{ GHz}}^{300 \text{ GHz}} \frac{S_i}{S_L} \leq 1 \quad (2.3)$$

Where,

J_i is the current density inducted at frequency i ,

$J_{L,i}$ is the inducted current density restriction at frequency i ,

SAR_i is the SAR caused by exposure at frequency i ,

SAR_L is the SAR limit,

S_i is the power density at frequency i .

The formulas 2.4 and 2.5 apply to field levels at frequencies up to 10 MHz and are associated with induced current density and electrical stimulation effects.

$$\sum_{i=1 \text{ Hz}}^{1 \text{ MHz}} \frac{E_i}{E_{L,i}} + \sum_{i>1 \text{ MHz}}^{10 \text{ MHz}} \frac{E_i}{a} \leq 1 \quad (2.4)$$

$$\sum_{j=1 \text{ Hz}}^{65 \text{ kHz}} \frac{H_j}{H_{L,j}} + \sum_{j>65 \text{ kHz}}^{10 \text{ MHz}} \frac{H_j}{b} \leq 1 \quad (2.5)$$

Where,

E_i is the electric field strength at frequency I ,

$E_{L,i}$ is the electric field reference level,

H_j is the magnetic field strength at frequency j ,

$H_{L,j}$ is the magnetic field reference level,

a is equal to 610 Vm^{-1} for occupational exposure and 87 Vm^{-1} for general public exposure

b is equal to 24.4 Am^{-1} ($30.7 \text{ } \mu\text{T}$) for occupational exposure and 5 Am^{-1} ($6.25 \text{ } \mu\text{T}$) for general public exposure.

The values a and b are constants that used above 1 MHz for the electric field and above 65 KHz for magnetic field.

For thermal effects related to higher frequencies of 100 KHz, the following mathematical formulas (2.6) and (2.7) should be applied.

$$\sum_{i=100 \text{ kHz}}^{1 \text{ MHz}} \frac{E_i}{c} + \sum_{i>1 \text{ MHz}}^{300 \text{ GHz}} \left(\frac{E_i}{E_{L,i}} \right)^2 \leq 1 \quad (2.6)$$

$$\sum_{j=100 \text{ kHz}}^{1 \text{ MHz}} \frac{H_j}{d} + \sum_{j>1 \text{ MHz}}^{300 \text{ GHz}} \left(\frac{H_j}{H_{L,j}} \right)^2 \leq 1 \quad (2.7)$$

Where,

E_i is the electric field strength at frequency i ,

$E_{L,i}$ is the electric field reference level

H_j is the magnetic field strength at frequency j

$H_{L,i}$ is the magnetic field reference level

c is equal to $610/f \text{ Vm}^{-1}$ for occupational exposure and $87/f^{1/2} \text{ Vm}^{-1}$ for general public exposure

d is equal to $1.6/f \text{ Am}^{-1}$ for occupational exposure and $0.73/f \text{ Am}^{-1}$ for general public exposure

For c and d values f is frequency calculated in MHz.

Moreover, requirements presented in the following mathematical formula (2.8) should be taken into account for limb current and contact current cases.

$$\sum_{k=10 \text{ MHz}}^{110 \text{ MHz}} \left(\frac{I_k}{I_{L,k}} \right)^2 \leq 1 \quad \sum_{n=1 \text{ Hz}}^{110 \text{ MHz}} \frac{I_n}{I_{C,n}} \leq 1 \quad (2.8)$$

I_k is limb current component at frequency k

$I_{L,k}$ is the reference level of limb current

I_n is the contact current component at frequency n

$I_{C,n}$ is the reference level of contact current at frequency n

The above mathematical formulas assume worst-case circumstances of simultaneous exposure to multiple frequencies electromagnetic fields.

Chapter 3 - EMF exposure measurements methodology

3.1 General remarks

Measuring exposure to electromagnetic radiation is a very complex and time consuming process. If measurements are taken with spectrum analyzers, then the spectrum analyzer settings must be made with accuracy and according to measurement protocols that apply in each case. For this reason it is very important to take measurements via automated software, relating to the spectrum analyzer and to undertake and make all the necessary settings and operations to perform correct measurements. In this master thesis measurements, that, performed with an application that implemented by using open source software, will be presented. For the measurement procedure a Linux computer, a spectrum analyzer and an antenna are used. The presented software supports the connection with the spectrum analyzer via network with Ethernet cable or via USB with GPIB cable.

3.2 Broadband and narrowband measurements

In electromagnetic field measurements two methods of measurement are mainly used, the narrowband measurements and broadband measurements. A broadband measurement detects all signals presented on a certain frequency band. The usefulness of this measurement is to calculate the total effect of exposure to electromagnetic radiation on the human body. For electromagnetic radiation measurements using the broadband method, a field meter with the use of appropriate shaped probes can be used to display the total exposure as a percentage of the relevant limit. This help to avoid time-consuming computations and comparison of results with limit tables [30]. Beside the ease of the broadband measurement procedure, this method cannot determine the contribution of each frequency separately in a multi-source transmission environment. Consequently, exposure to electromagnetic radiation is not accurately estimated since the reference levels are dependent on the transmission frequency.

The narrowband measurement method, resolves this problem, since the measurement of the signal strength is received at each individual frequency. Therefore, estimation of exposure to electromagnetic radiation can be achieved with great precision even in an environment with multiple transmission sources. For narrowband measurements spectral analyzers which can be tuned on a selected frequency and provide the field strength corresponding to the same frequency, with other complex equipment have to be used. These instruments give information about the spectral characteristics of the measured fields. The considered bandwidth has to be so narrow to allow accurate measurements of single components at different frequencies. This process is time-consuming and complicated in both measuring EMF and evaluating the results. For measurements performed in this thesis, narrowband method was used.

3.2 Spectrum Analyzer fundamentals

One of the most important instruments used for electromagnetic radiation measurements, but also more generally in the telecommunications field it is spectrum analyzer. Contrary to oscilloscope that captures the signal amplitude in the time unit, spectrum analyzer logs the signal amplitude versus frequency. Thus, spectrum analyzer can measure the harmonic frequency signals, bandwidth and periodic change of them. The most common measurements made with spectrum analyzer are configuration, distortion and noise. Figure 3.1 below displays the connection of the time domain to the frequency domain, and how the measurement of a signal is shown in both time and frequency domain. The method of measurement will be discussed more extensively in subsection 3.3.

Figure 3.1 Relation between time and frequency domain

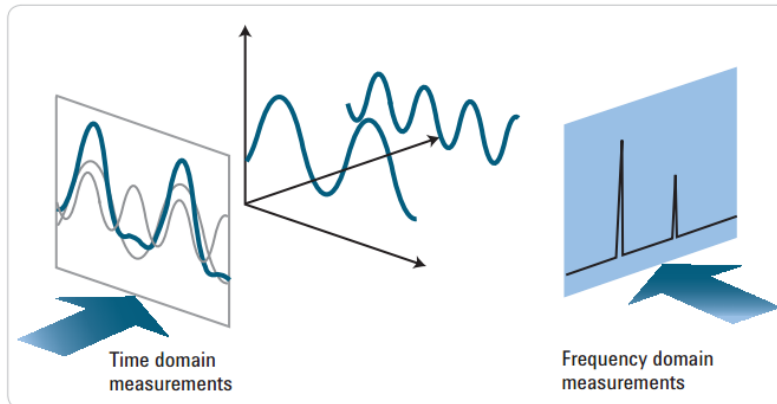

In the time domain, all frequency components are summed and displayed in total, while in the frequency domain, signals consisting of more than one frequencies are separated to different frequency components, and level at each frequency is separately displayed.

The spectrum analyzer has several advantages. For example, if a signal that on oscilloscope would be displayed as a simple wave, it may be composed of many different frequencies, which easily can be captured in the spectral analyzer. That would be very difficult to be ascertained if an oscilloscope was used. Frequency domain is better for determining the harmonic content of a signal, for that the analysis in the spectral domain is particularly important in wireless communications. The transmitted signals are often checked for possible interferences that may occur from the harmonics of the carrier signal, with other systems operating on the same frequencies as the harmonics. Moreover, many of the telecommunications systems use communication protocols associated with frequencies, such as FDMA in which different users occupy different frequencies to communicate as in cellular phones, and FDM which is used during broadcast from radio stations, where each station occupies a specific frequency band.

Spectrum analyzers separated into two types, Fourier and Swept analyzers, depending on how they measure the frequency domain. The first type concerns analyzers using Fourier analysis. Such analyzers receive the transmitted signal in the time domain and by using mathematical formulas, converts it to the spectral range and displays it. A Fourier analyzer is

able to measure phase as well as magnitude and is faster than the classic swept analyzer, but has limitations particularly in the areas of frequency range, sensitivity, and dynamic range.

On the other hand, swept-tuned type spectrum analyzers, are those which commonly used in frequency domain measurements. These analyzers operate using superheterodyne technique. The term super corresponding to super-audio frequencies and the term heterodyne means mix; and that is, to translate frequency. The swept analyzers are based on the scanning of the entire frequency range preset by the operator, and displaying all the present frequency components. This method is ideal for wireless systems as mobile, FM, TV etc., permitting measurements over a large dynamic range and a wide frequency range, in the frequency domain.

In order to understand how a spectrum analyzer function, we must consider the internal parts which it is comprised. In the figure 3.2 below the block diagram of a traditional swept type spectrum analyzer is distinguished.

Figure 3.2 Block diagram of a traditional swept-tuned spectrum analyzer.

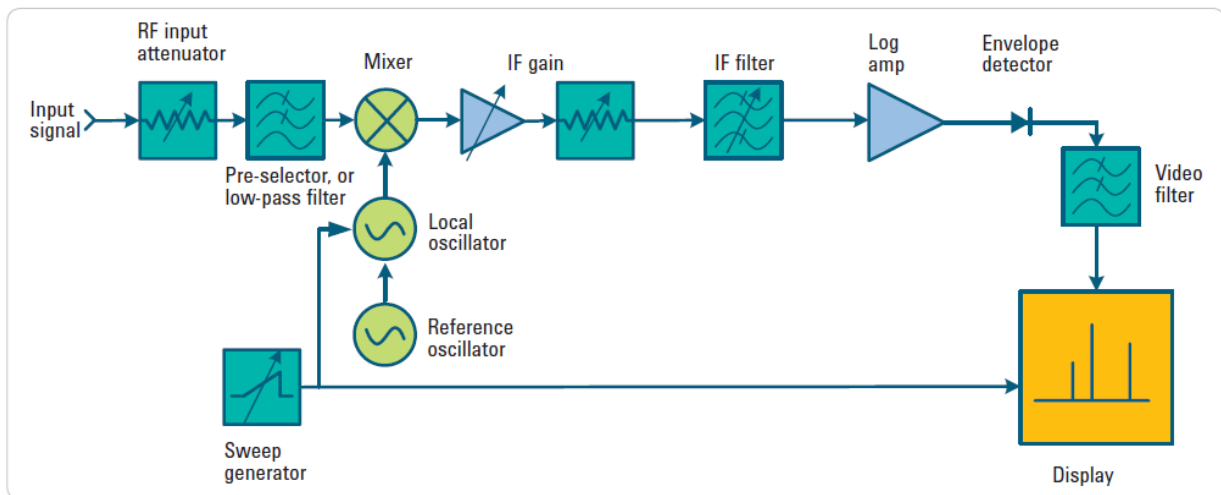

As mentioned above, a basic feature of swept-type spectrum analyzer's operation is the principle of superheterodyne. This principle uses a mixer and a second locally generated local oscillator signal to translate the frequency. More specific, the input signal is passed through an attenuator. The input signal enters into the mixer which is non-linear device, after having passed through the low pass filter. Into the mixer it is combined with another signal, generated by the

local oscillator. The mixer includes the two original signals with their harmonics as well as the sums and differences of the original signals and their harmonics too. Then, these mixed signals pass into the IF filter which filters the signals that not corresponding to its settings, and separates any relevance signals, for further correction of the envelope detector. Finally, the signals are digitized by the video filter and displayed on the analyzer's screen. The appearance of the signal on display is made as a scrolling form from left to the right. The movement is prepared by the sweep generator. This generator drives the sweep of the local oscillator and also the display.

A brief analysis of the elements that consists a sweep spectrum analyzer, follows below.

- RF attenuator: Initially, the signal inputs into the spectrum analyzer. The first element that the incoming signal meets is an RF attenuator. This attenuator regulates incoming signal to the optimum level. If the input signal is too high, it cannot be properly displayed on the analyzer display, and also cannot become an optimal management of this signal by the mixer. The RF attenuator can protect the mixer from possible damage due to high power input signals. Because of these mixers are high-performance components, replacing them is very costly. Also, the input attenuator contains a capacitor which undertakes to protect the mixer from any DC that may occur on the line being measured.
- Low pass filter and pre-selector: After the signal exiting from the RF attenuator, the signal enters to Low pass filter and Pre-selector. This component removes the out-of-band signals, which create undesirable responses at IF and also prevents from mixing with the local oscillator and for appearing to analyzers display. Next component that signal reaches is the mixer.
- Mixer: The quality of the analyzer greatly depends on the mixer. The mixers are very expensive and high-performance components. They should be able to manage a wide range of signals as well as to have a small amount of incorrect responses to prevent false signals to be generated and present on spectrum analyzer's display.

- IF gain: Following the mixer, the output signal passes through an additional amplifier, the IF gain, to ensure that the gain level is the desired. A large enough gain level can lead to noise increasing and masking of low level signals. A proper method for optimum noise performance is the RF gain control generally be kept at the highest possible level without overloading the mixer. The IF gain is automatically adjusted to an abrupt change of input attenuation in order to offset the effect of this modify. Thus, the final representation of the signal on the spectrum analyzer display remains constant.
- IF filter: The IF filter is used to detect signals having a bandwidth known as a resolution bandwidth that can be adjusted by the analyst. By decreasing the resolution bandwidth, displayed frequencies are optimized. For example, signals at close frequencies enough distinct. However, decreasing the resolution, costs to frequency selectivity, SNR, and measurement speed. Figure 3.3 shows the SNR increasing as IF Bandwidth decreases. Resolution comes into play because the IF filters are band-limited circuits that require finite times to charge and discharge. If the mixing products are swept through them too quickly, there will be a loss of displayed amplitude [31]. The time that mixing products stays in the pass band of the IF filter is proportional to resolution bandwidth (RBW) and sweep time (ST) and is presented in Mathematical formula 3.1 below.

$$Time\ in\ passband = \frac{RBW}{\frac{Span}{ST}} = \frac{RBW \cdot ST}{Span} \quad (3.1)$$

Figure 3.3 SNR related to RBW

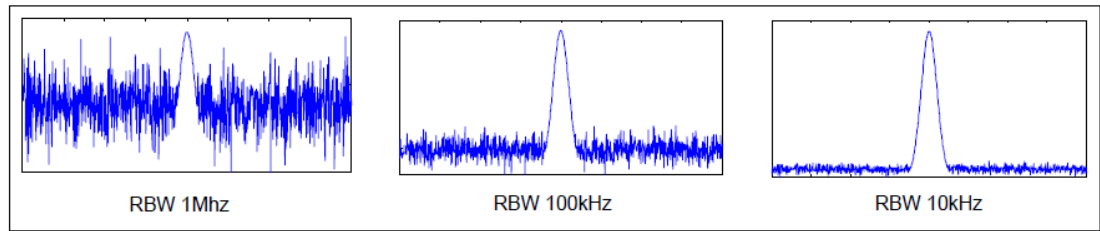

- **Envelop Detector:** The detector allows the analyzer to convert the signal from IF filter into a digital signal that can be display on analyzer’s screen. After the signal enters the envelop detector, is converted to video through an analog-to-digital converter and presented at the spectrum analyzer’s display as the signal’s amplitude. The type of detector used may depend on the kind of measurement and can be Average or Route-Mean-Square (RMS). The difference between the RMS and the Average detector is that in RMS the samples are squared, added and the sum divided by the number of samples. The RMS value is calculated from the root of the previous result. In average detector, the samples are simply added and this sum is divided by the total number of samples with result the average value. The following figure 3.4 shows a width modulated sine wave signal as it enters the detector. The output of the detector presents the changes in the envelop of the IF signal, but not the instantaneous value of the IF sine wave itself [32].

Figure 3.4 Envelop Detector

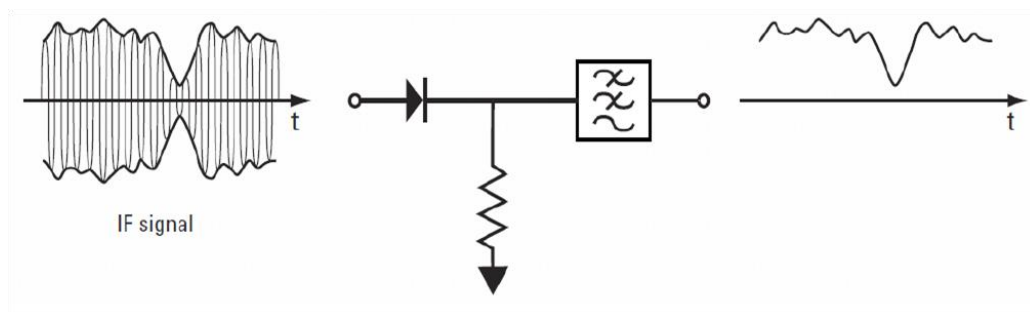

- **Video Filter:** After the envelop detector the low-pass video filter is located. The role of this component is to smooth and average the trace shown on the analyzer’s screen by determine the video amplifier bandwidth. The correct setting of the

video bandwidth can make signals obscured by noise, more visible. Figure 3.5 displays a signal with two different video bandwidth filter settings.

Figure 3.5 Signal with two different Video bandwidth filter setting

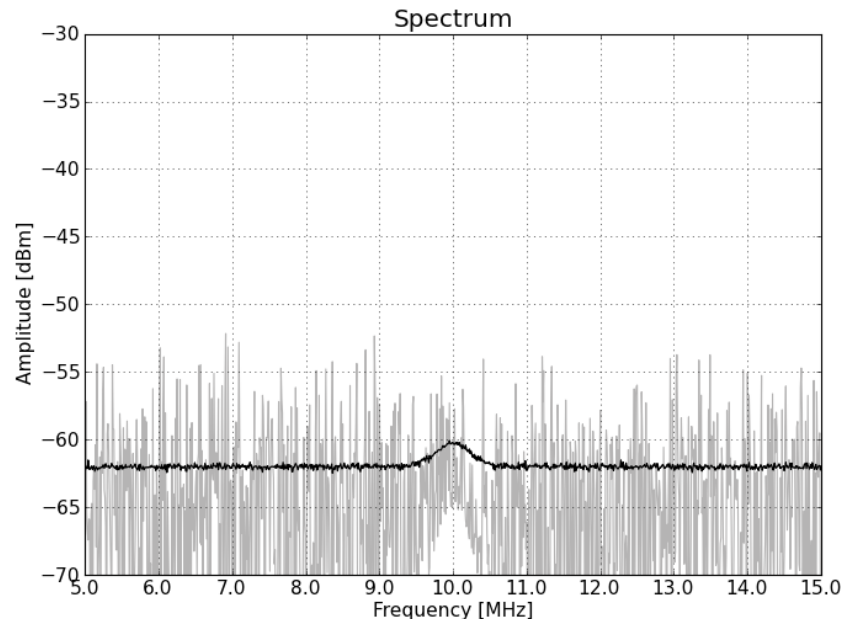

- Local Oscillator: One of the most basic elements of the spectrum analyzer is the local oscillator. The local oscillator is voltage-controlled and must be coordinated in a fairly wide frequency range to enable the analyzer to scan over the required range. Its coordination is done by the sweep generator and changes in proportion to the ramp voltage.
- Sweep generator: The sweep generator operates based on the setting made through the spectrum analyzer and refers to the sweep rate. Since the sweep generator besides the local oscillator also synchronizes the video signal too, for generating the x-axis of frequency, and because the local oscillator is associated with the input signal, the x-axis is calibrated in frequency of the input signal.
- Display: The display is the element of the spectrum analyzer in which the user can observe all of the information of the measurement and also to modify the settings of spectrum analyzer. Display presents the frequency of the measured signal in

the x-axis and amplitude in the y-axis. Also on display during the measurement process, items such as markers for minimum signal, maximum peak, auto peak, highlighting and many more elements can be controlled. Previously, displays used by the spectral analyzers were cathode ray tubes, but nowadays these displays are of liquid crystals (LCD) and provide flexibility and quality required for the proper illustration of the measurement.

- Display detectors: The display detectors are different from the envelope detectors that convert the IF signal to a video signal, and should not be confused. The term “Detector” refers to the choice of signal processing, for the conversion of the video signal to an array of digital results. Regardless of the data points used in the analyzer display, each point must represent what has happened over some range of frequencies and over some time interval. For each interval, the data are thrown in a bucket and mathematical formulas are applied in order to obtain the desired results, which are stored, and then appear on the analyzer display. Each bucket contains data from a span and the time period determined by the following mathematical formulas (3.2) and (3.3).

$$\text{Frequency: bucket width} = \frac{\text{Span}}{\text{Trace Points} - 1} \quad (3.2)$$

$$\text{Time: bucket width} = \frac{\text{Sweep Time}}{\text{Trace Points} - 1} \quad (3.3)$$

The “bucket” can be also termed as “points” and “pixels”. Its concept is important because it helps to separate six detector types. These are Positive peak, Negative peak, Sample, Normal, Average and Quasi-peak. The positive peak detector (also simply called and peak detector) stores the largest signal for subsequent A/D conversion. The negative peak detector stores the lowest amplitude signal and the sample detector merely store the final amplitude [33]. These first three detectors

are easier to understand and are presented in next figure 3.6, in spite the other three (normal, average and quasi-peak) which are more complex and we will not further expand on them.

Figure 3.6 Example of Positive peak, Negative peak and Sample Detectors

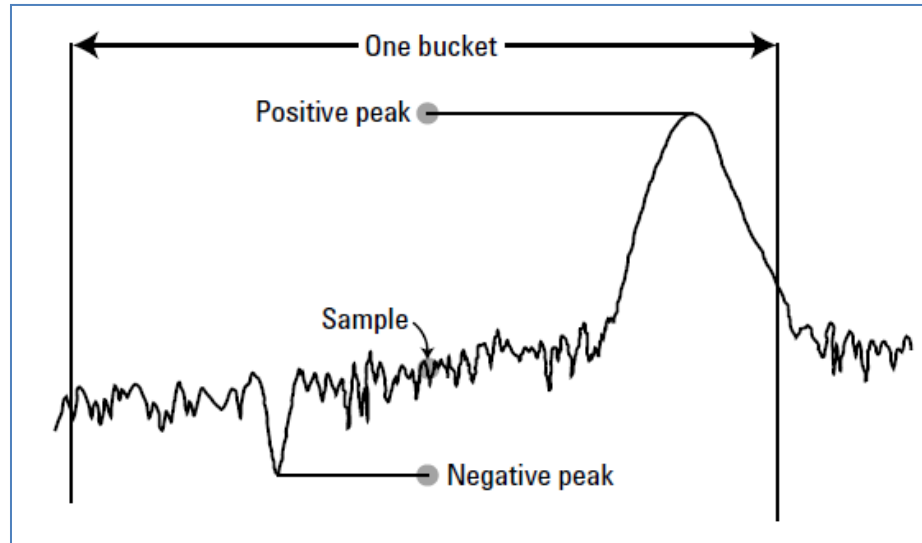

The software presented through this master thesis, offers default settings of Resolution Bandwidth, Video Bandwidth, Detector, Sweep Time etc. Also automatically adjusting the Reference Level and Input Attenuation for each frequency band separately is possible. Finally, the above settings can also accept and manual values by the operator, as will be presented in the the chapters regarding the analysis of the developed software.

3.3 Methodology of measurements

To determine the level of exposure to electromagnetic radiation and to estimate the compliance to the relative safety limits, specified quantities should be calculated. These quantities are electric field strength – E (V/m), magnetic field strength – H (A/m), magnetic flux density – B (T), and equivalent plane wave power density – S (W/m^2). The methodology followed in this thesis includes electromagnetic radiation measurements with spectrum

analyzers, by using an application that has been developed entirely in free and open source software and fully automates the process of measurement and also estimate the results compared with the existing safety limits.

First the proper point of measurement is important to be determined according the general guidelines. The measurement point should be selected in such a way so as to represent the locations with the highest exposure levels that a human can be exposed, taking into account the locations of adjacent antennas. This is where the antenna used for measurements is placed. This antenna should have a distance of 1.5 meters above the ground. All measurements should be performed in the far field (known as Fraunhofer region) where the angular field distribution is essentially independent of the distance from the antenna. This field is located at a distance determined by the following mathematical formula (3.4). In this area, the electric and magnetic field strengths are distributed evenly.

$$R = 2 * \frac{D^2}{\lambda} \quad (3.4)$$

Where,

- R distance of far field region for the antenna that is measured
- D is the largest dimension of the antenna
- λ is the wavelength

The measuring antenna is connected to the spectrum analyzer by RF cables which have been checked for any mechanical damage. The spectrum analyzer must be calibrated according to the manufacturer's recommendation. Thereafter the analyzer is connected to the laptop containing the software developed to automate the measurement process, with GPIB or Ethernet cable. After the connection of spectrum analyzer with the software, the analyzer is properly configured for each measurement frequency band that has been selected by the operator. Software recognize the model and type of spectrum analyzer automatically - of course in case that the spectrum analyzer exist in software's database - and loads the respective commands from

the database. The user have to select the type of antenna and the direction of measurement which can be X, Y or Z. For EMF measurements an omnidirectional antenna is suggested to be used. In case that this type of antenna is not available then for best results and to compensate for the unknown polarization of EMF incident field, a type of rotator (manual or automatic) is proposed to be used [34], [35], [36] and [37]. The software supports the connection with ARC-PCD8250 antenna rotator from Austrian Research Centers (ARC) which is able to rotate the used dipole type antenna model ARC-PCD8250 in three mutually perpendicular polarizations. All the commands for antenna rotating are given from the software automatically. For this reason the described software has been implemented with a specific subroutine which is able to rotate the ARC rotator at preprogrammed or the user desired polarizations.

When the measurement process begins, the software loads the predefined default settings and commands that should be used, separately for each selected by the operator frequency bands and configures the spectrum analyzer respectively. These settings consists of start and stop frequency, resolution bandwidth, video bandwidth, number of sweep points, sweep time, input attenuation, reference level, scale type etc. Moreover the measurement parameters can be easily configured manually from the operator. The software automatically captures the measurement data from the spectrum analyzer, which are the trace of Power in dBm vs Frequency, for a specific timeframe. These data supplemented with spectrum analyzer, antenna and connection cables are either processed for the estimation of compliance with the reference levels imposed by the Greek legislation or they are stored in a spreadsheet file (ods type) for further processing. For measurement to be valid, all guidelines given in [38], [39], [40] and [41] are followed. In the following section reference is made to mathematical calculations that are used for the evaluation of exposure to electromagnetic radiation.

3.4 Mathematical analysis of EMF exposure measurements

According to ICNIRP Guidelines [24] compliance with the reference levels is achieved when the mathematical equations (2.3), (2.4), (2.5)and (2.6) that mentioned in chapter 2.2.4 are valid in our measurements. Therefore the quantities power density, electric field strength and

magnetic field strength have to be measured. Because of the connection between these quantities as shown in the following mathematical equations (3.5), only one of them should be calculated.

$$S = E * H = \frac{E^2}{\eta} = \eta * H^2 \quad (3.5)$$

Where “ η ” is the characteristic resistance of free space, equal to 120π Ohms.

For the calculation of the quantities S, H and E the following computations are taken into account: The trace points P_i (power in dBm at frequency f_i) in the SA output are corrected for the equivalent noise bandwidth imposed by intermediate frequency filter (RBW filter). [42]. The correction factor is expressed (in dBm) by the mathematical equation (3.6) bellow.

$$P_c = 10 \cdot \log_{10} \frac{B_{ch}}{B_{noise}} \cdot \frac{1}{N} \quad (3.6)$$

Where,

N is the number of trace points

B_{ch} is the specified bandwidth (integration bandwidth)

B_{noise} is the equivalent noise bandwidth of the resolution Bandwidth filter used by the SA and is expressed by the (3.7) mathematical type:

$$B_{noise} = k \cdot RBW \quad (3.7)$$

Where,

RBW is the 3 dB bandwidth of the Resolution Bandwidth filter used

k is proportionality correction factor for B_{noise}

Channel Power is the total received power over a frequency band and is equal to:

$$Channel\ Power = \sum_{i=1}^N 10^{\frac{P_{ci}}{10}} = \sum_{i=1}^N 10^{\frac{P_c + P_i}{10}} = \frac{B_{ch}}{B_{noise}} \cdot \frac{1}{N} \cdot \sum_{i=1}^N 10^{\frac{P_i}{10}} \quad (3.8)$$

With channel power method the average power across the frequency band of interest can be measured [43]. The Channel Power is very useful when we measure pulsed radar because it has complex signals and often the PRF and the pulse width are changed [44]. Thus, the spectrum of these signals is also complex and the power cannot be easily calculated from the spectrum [45], and [46].

Calculation of the power $P_{in}(f_i)$ in dBm at frequency f_i , at the input of the receiving antenna is following. P_{in} is expressed as the sum of output power and total losses (mathematical equation 3.9).

$$P_{in}(f_i) = P_{out}(f_i) + L_{total}(f_i) \quad (3.9)$$

Input power and total losses are calculated according (3.10) and (3.11):

$$P_{out}(f_i) = P_i + P_c \quad (3.10)$$

$$L_{total}(f_i) = \sum_{j=1}^m L_{ji} - G_{dB}(f_i) \quad (3.11)$$

Where,

L_{ji} is the frequency dependent loss of each (j) component of the measurement (cables, connectors, external attenuators etc.) at f_i , in dBm

$G_{dB}(f_i)$ is the antenna gain at f_i . frequency, in dBi

As we know to convert a number to dB, is just to multiply the decimal logarithm of the number with number ten (3.12).

$$G_{dB}(f_i) = 10 \cdot \log_{10} G_i \quad (3.12)$$

Where G_i is the gain of antenna at frequency f_i .

Moreover the antenna factor in dB at frequency f_i and the effective area of the antenna in m^2 at frequency f_i can be calculated by using (3.13) and (3.14):

$$AF_{dB}(f_i) = 10 \cdot \log_{10} \left(\frac{9.73}{\lambda \cdot \sqrt{G_i}} \right) \quad (3.13)$$

$$AF_{dB}(f_i) = \frac{\lambda^2 \cdot G_i}{4 \cdot \pi} = \frac{9 \cdot 10^8 \cdot G_i}{4 \cdot \pi \cdot f_i^2} \quad (3.14)$$

By calculating the above quantities, we can also easily calculate the power density at the input of the measuring system both in dBm and in W/m^2 by using the mathematical formulas (3.15) and (3.16) respectively.

$$S_{in,dBm}(f_i) = -48.7 + P_{out}(f_i) + L_{total}(f_i) + AF_{dB}(f_i) \quad (3.15)$$

$$S_{in}(f_i) = 10 \cdot 10^{\frac{S_{in,dBm}(f_i)}{10}} \quad (3.16)$$

Since the power density is related with the electromagnetic field strength and the magnetic field strength as we have seen in the mathematical formula (3.2), we can now calculate the electric field strength and the magnetic field strength at the entrance to the measuring system as follows (3.17), (3.18):

$$E_{in}(f_i) = \sqrt{120 \cdot \pi \cdot S_{in}(f_i)} \quad (3.17)$$

$$H_{in}(f_i) = \sqrt{\frac{S_{in}(f_i)}{120 \cdot \pi}} \quad (3.18)$$

After all the above steps and calculations carried out for all three directions X,Y and Z of the receiving antenna, the total electric field strength can be calculated with the use of the following equation (3.19):

$$E_{total}(f_i) = \sqrt{E_{in,x}(f_i)^2 + E_{in,y}(f_i)^2 + E_{in,z}(f_i)^2} \quad (3.19)$$

Currently, the final multiple sources exposure factor for both the electric and the magnetic fields can be calculated by using (3.20) and (3.21) respectively:

$$sumE_{in} = \sum_{i \geq f_{start}}^{i \leq f_{stop}} \left(\frac{E_{total}(f_i)}{E_{limit}(f_i)} \right)^2 \quad (3.20)$$

$$sumH_{in} = \sum_{i \geq f_{start}}^{i \leq f_{stop}} \left(\frac{H_{total}(f_i)}{H_{limit}(f_i)} \right)^2 \quad (3.21)$$

Where $E_{total}(f_i)$, $H_{total}(f_i)$ are the electric field and the magnetic field at a frequency f_i and $E_{limit}(f_i)$ and $H_{limit}(f_i)$ are the reference levels of the electric and magnetic field strength, at the frequency f_i respectively. According to the above calculations and also the instructions and

established limits that have been mentioned in section 2.2.3, the total exposure to electromagnetic radiation is estimated.

3.5 Uncertainty of measurements

3.5.1 General Remarks

Since ancient times, Aristotle had formulated the certainty and uncertainty of a result. Up to now the measurement uncertainty is an issue that has preoccupied scientists. Nowadays various research centers and organizations, as International Organization for Standards (ISO), that they develop methodologies for determining the measurement of uncertainty. The uncertainty of measurement is the difference between the actual value of a quantity which is measured and the final result of a measurement process [47]. The contribution to the overall uncertainty can be calculated from calibration measurements, or according to the manufacturer's specifications.

According to [48], there are many possible sources of uncertainty in a measurement, including:

- Incomplete definition of the measurand
- Imperfect realization of the definition of the measurand
- Non representative sampling — the sample measured may not represent the defined measurand
- Inadequate knowledge of the effects of environmental conditions on the measurement or imperfect
- Measurement of environmental conditions;
- Personal bias in reading analogue instruments
- Finite instrument resolution or discrimination threshold
- Inexact values of measurement standards and reference materials
- Inexact values of constants and other parameters obtained from external sources and used in the data-reduction algorithm

- Approximations and assumptions incorporated in the measurement method and procedure
- Variations in repeated observations of the measurand under apparently identical conditions.

3.5.2 Evaluation of uncertainty components

No matter how many times you repeat a measurement, the result will not always be exactly the same but has a deviation to some extent. Even if the measurement is made under the same conditions, there is always someone uncontrolled factor that may adversely affect even to a small extent the result. For estimating uncertainty, all factors that introduce some error in the measurement of electromagnetic fields are first recorded, whether they are external or is internal compared with the measurement system. A categorization of uncertainties that these factors contribute is the systematic effects and the random effects. Systematic effects are repeated with the experiment and there is a reason that creates them. They are owed to the equipment used in measurement (instruments, cables, etc.) and are often hard to detect. However, with proper calibration these effects can be eliminated. On the other hand, random effects are not repeated with the experiment, but are due to random incidents. Random effects cannot be eliminated and their value changes even if the measurement is being at the exact same conditions. However, confusion may occur since a systematic component with a metric may be random component in another measurement. To overcome this ambiguity uncertainties are categorizing based on the calculation method of the components into two types [49], [50]. Thus, the uncertainties are divided into two categories.

Type-A refers to uncertainties calculated using statistical methods resulting from the repetition of measurements and is used when the result x of measurement derived from the values x_i , $i = 1, 2, \dots, n$ of “ n ” independent repeated measurements of a non-variable quantity x , under controlled conditions of repeatability using instrumentation characterized by insignificant deviation in the time duration of the measurement. Type-B refers to uncertainties calculated with different methods, for example through the manufacturer's specifications and datasheets or via experience from previous measurements. Mathematical formula (3.22) is the basic equation for type-B uncertainties calculation,

$$U_s = k \cdot s^2 = k \cdot \sqrt{s_{sa}^2 + s_{sg}^2} \quad (3.22)$$

where,

s_{sa} is the standard deviation in the case of rectangular distribution

s_{sg} is the standard deviation in the case of normal distribution

For the calculation of the overall measurement uncertainty the method of the International Bureau of Weights and Measures (BIPM) [48], proposed by the ETSI (European Telecommunications Standard Institute), has to be adopted. To accomplish this, the following procedure, according to [50], has to be performed.

Initially, description is made on each uncertainty component that contributes to the overall uncertainty with a calculated standard deviation which is defined as a standard uncertainty (u). Standard uncertainties of type-A and type-B are denoted by u_i and u_j respectively. Then, the combined standard uncertainty is estimated (u_c) is estimated, which is obtained by the root of the sum of squares of the standard uncertainties (RSS), on condition that the components are stochastic and independent and aggregated affect the total uncertainty.

For the estimation of expanded uncertainty, the combined standard uncertainty is multiplied by a constant k_{xx} , which is called coverage factor. For example, when the combined standard uncertainty follows normal distribution, the expanded uncertainty corresponds to a confidence level of 68% for $k_{xx} = 1$, while corresponds to a confidence level of 95% for $k_{xx} = 1,96$. The information provided for the uncertainty factors whether they are derived from the manufacturer through measurements, or experience, are usually provided in form $\pm a$. In other words, the upper (+a) and lower (-a) limit of uncertainty or the period of uncertainty lies (2a), is given. If the contribution of uncertainty components are cumulative then just linear terms should be used (e.g. voltage, % rate, etc.), while if the contribution is multiplicative, then just logarithmic terms should be used (dB). However, for small standard uncertainties (<30% or 2.5 dB) we can carry out in common calculations for multiplier and cumulative contributions, provided that all components are first expressed in a common unit. When uncertainty

components are not expressed in the same units (% voltage or power rate, absolute voltage or power values, dB), before the combined standard uncertainty is calculated, it must be conversion of all the expressions in order to have a common unit. As a common unit dB is selected.

For the calculation of the expanded uncertainty, confidence level of 95% will be assumed and therefore the coverage factor is $k_{95} = 1.96$. This means that the overall uncertainty will lie in the range $2 \cdot u_c$ at 95% possibility.

3.5.3 Estimation of uncertainty using spectrum analyzer

In order to determine the combined standard uncertainty u_c , if any of the standard uncertainties are not already expressed in the measured quantity, then they should be converted by using the appropriate sensitivity coefficient c_i , and then: $u_i = c_i \cdot u(x_i)$. For calculating the total uncertainty in a measurement with spectrum analyzer, RSS method at % values of the individual uncertainties is used. According to [35] and [51] the standard uncertainty $u(x_i)$ and the sensitivity coefficient c_i shall be evaluated for the estimate x_i of each quantity. The combined standard uncertainty $u_c(y)$ of the estimate y of the measurand is given by equation (3.23):

$$U_c(y) = \sqrt{\sum_{i=1}^n (c_i \cdot u(x_i))^2} \quad (3.23)$$

The expanded measurement uncertainty u_e is calculated from (3.24):

$$u_e = k \cdot u_c = 1.96 \cdot u_c \quad (3.24)$$

for constant $k = 1,96$ which corresponds to a confidence level of 95%.

Chapter 4 - Software Implementation

4.1 General Remarks

This chapter presents the process that application has been implemented, the programming languages, modules and libraries that was used and licenses of free and open source software. Also a comparative reference to several other similar software, which have been implemented in the past for commercial or educational purposes is made.

4.2 Free and Open Source Software Terms and Licenses

As already mentioned in the previous chapter, the software developed in this thesis is completely implemented in free and open source software. What exactly these terms mean, which are the benefits and advantages they have, and from what licenses are they governed, will be analyzed in this subchapter.

4.2.1 Free and Open Source Software benefits and advantages

Free software and open source software has become the backbone of modern information technology. It runs on mobile phones, on laptop and desktop computers, and in embedded microcontrollers for household appliances, automobiles, industrial machinery and countless other devices that we too often forget even have software. Open source is especially prevalent on the servers that provide online services on the Internet [52]. Often made confuse of the term free software with freeware software that available free of charge to the public. Free software refers to freedom, not price, and relates on software that is licensed under the Free Software Foundation (FSF) [53] and General Public License (GNU) [54]. This software can freely use, copy, distribute and modify by anyone according to his needs. It is an alternative development model and Software use, based on the freely available source code, which allows changes or improvements in order to cover needs of the one who uses it [55].

Free and open source software is perfectly legal and is available most of the times without any cost, while the cost of maintenance, if this exists, is very low. In this software, unlike commercial software which licenses are usually costly, there is no need to purchase licenses, while they offer an unlimited number of installations. The use of this software does not create dependent relationship by companies, while the error correction, distribution and development can be done by trained technical teams, which results in low prices with high quality support. Free and open source software has a great and friendly development and support community worldwide, consist of users and developers who cooperate to continuously improve and upgrade software with new versions at regular periods of time. This lends the advantage to continuously test the software by multiple users, and any bugs and security gaps to be immediately identified and also be corrected in a very short time. Furthermore is significantly safer and more reliable than with proprietary software downloaded from the Internet, while providing the opportunity to explore and learn the mode of software adjusting it to our needs.

Open source software is expanding because of heavy use of the web and constantly earning new users worldwide. Due to the above advantages that provides, it is increasingly used in education, in public administration and in businesses. Thereby, more and more resources are devoted to technical support with significant benefits for the local and national economy [55].

4.2.2 Free and Open Source Software Licenses

Although there exist many of different free and open source software licenses, almost all refer to similar things. Free software used to implement the application, are governed to their majority on the GNU General Public License (GPL) [56]. Some other licenses allow the covered code to be used in proprietary programs. Proprietary programs can contain some non-proprietary source code without affecting their licensing terms. These licenses are permissive free licenses (non-copyleft). Such proprietary-compatible types of licenses are BSD, Apache, X Consortium and MIT licenses types.

The GNU General Public License is a free, copyleft license and is intended to guarantee freedom of sharing and also changing all versions of a program while remaining free software.

General Public Licenses are designed to provide user the freedom to distribute copies of free software (and charge them if he wish), to receive source code, to change the software or to use pieces of it in new free programs. If someone distributes copies of a program that contains code of this license type, whether it is free or for a fee, must give to the recipients the same freedoms that he received, and make sure that they, too, receive or can get the source code. Moreover, he must show them these terms so they know their rights [57].

4.3 Ubuntu open source software

From the beginning of application developing, free and open source software was used. For this reason, the latest version -until that day- Linux-Ubuntu software was installed. This version was Ubuntu 14.04 LTS.

Ubuntu operating system software was introduced in 2004 and is based on the Debian which is considered the rock upon that Ubuntu is built. Debian is a volunteer project that has developed and maintained a GNU/Linux operating system of the same name for well over a decade [58]. Ubuntu is an open source and free operating system that includes the Kernel Linux, and implemented in order to offer to the user a friendly environment with easy installation and operation. The company behind the Ubuntu Linux operating system, Canonical, has recently changed the licensing terms of Ubuntu in order to comply with the GNU General Public License and other free software licenses. Nevertheless, this change regards to the projects covered by the GPL, but does not address other free individual works distributed by Ubuntu which may be covered by copyrights and weaker copyleft licenses.

Each new Ubuntu version is available by Canonical Ltd every six months. The version number stems from the year and month that software has released. For example, the first Ubuntu version that was released in October 2004 is 4.10. Version 14.04 LTS that is used in this thesis was released on April 17, 2014 and it is 20th edition of Ubuntu (Figure 4.1).

Figure 4.1 Version 14.04 LTS of Ubuntu operating system software

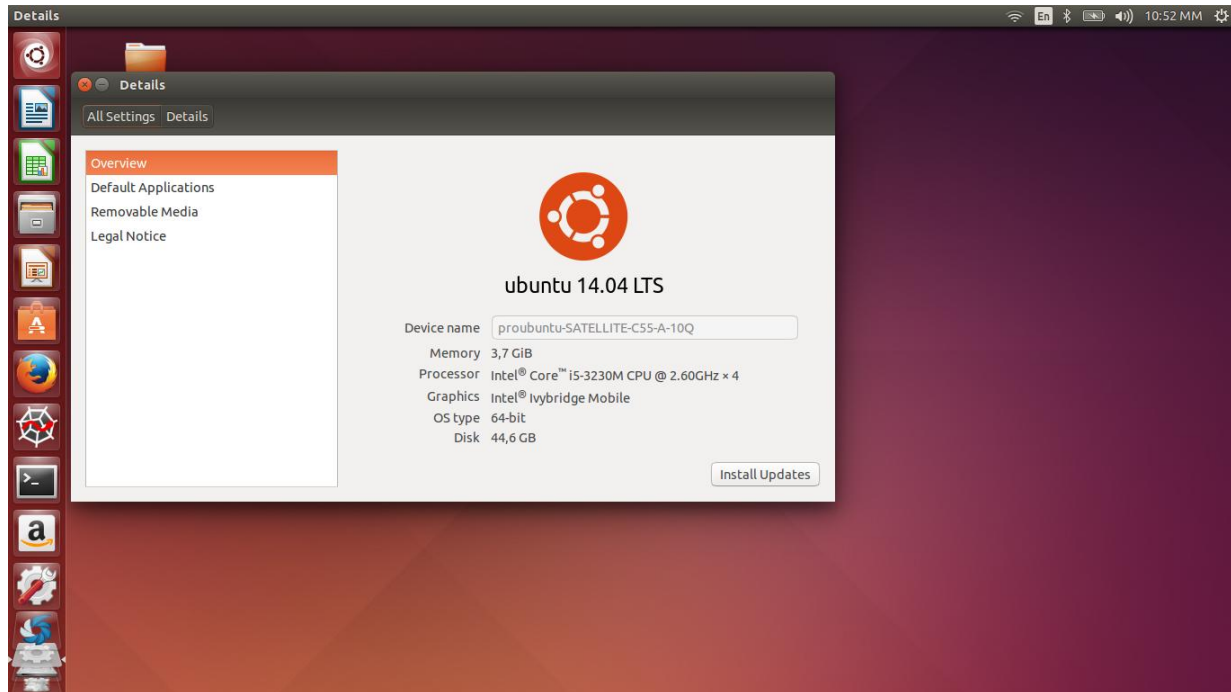

The LTS is acronym of the words Long-Term Support. The LTS defines that support and upgrades for this version lasts for a long time and is determined in each fourth edition that is released the second quarter of even-numbered years. In other words, a new LTS version is released every two years. In previous releases, LTS version had three years support on Ubuntu Desktop and five years on Ubuntu Server. Starting with Ubuntu 12.04 LTS, both versions received five years support [59], while for versions that are not LTS, technical support lasts for the next 18 months from their release. The Ubuntu LTS versions that have been circulated until now are 6.06, 8.04, 10.04, 12.04, 14.04 and 16.04.

4.4 Ubuntu open source software installation

The Ubuntu operating system that used in this thesis was downloaded from official website of the Ubuntu software [58]. After the downloading, an Ubuntu 14.04 LTS USB Boot stick was created. The computer used is running on Microsoft Windows 10 operating system and

for this reason a separate partition on the hard disk had to be made, to install the new Linux operating system on “Dual Boot” mode. Then, the computer rebooted from bootable USB and the version Ubuntu 14.04 LTS installed. The installation of Ubuntu was a simple process.

Nevertheless, during the installation, operator should pay attention to the field "Installation Type" which various options for the area that the user wants to install the software are offered. This option consists automatically or manually selection of install area, and create or resize partitions in case of other software existence (Figure 4.2).

Figure 4.2 Ubuntu LTS 14.04 Installation type selection menu

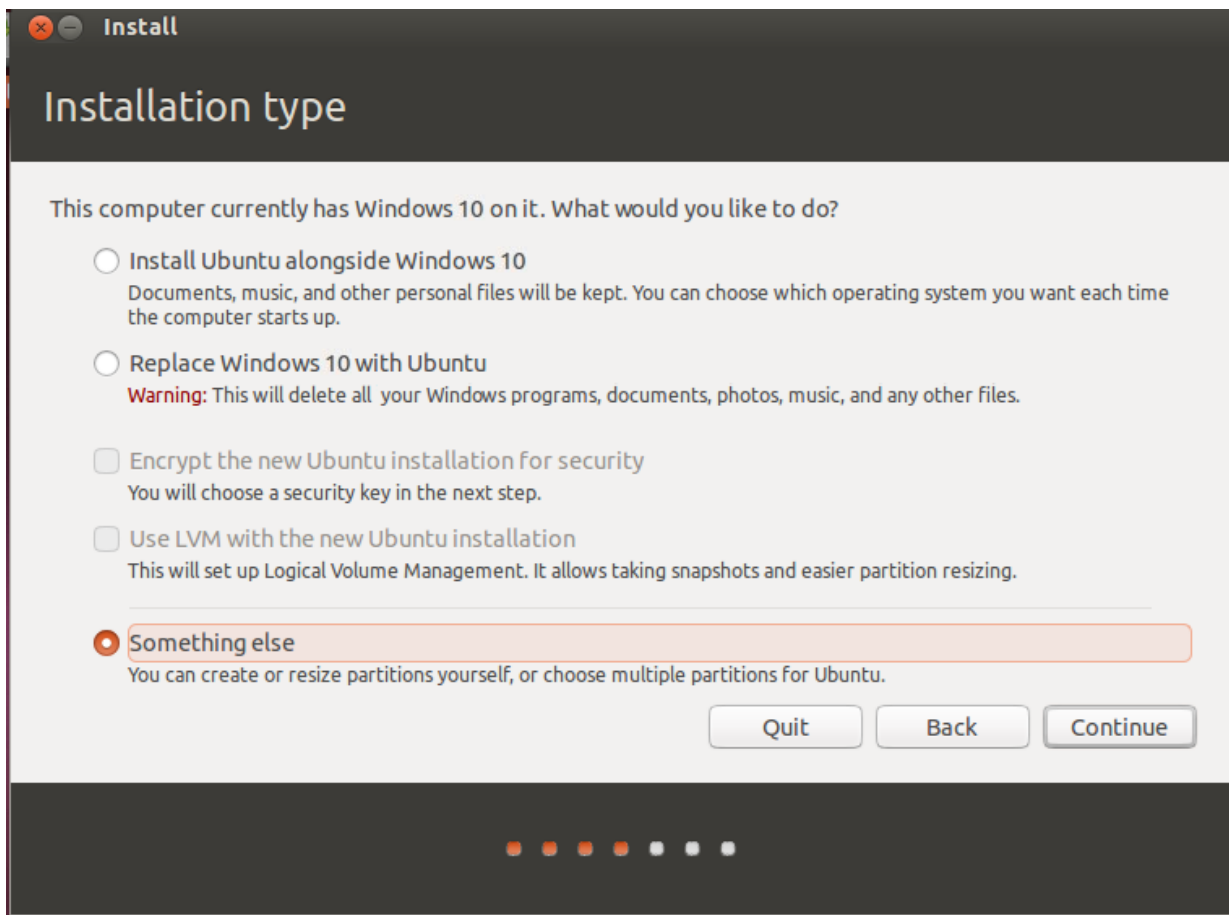

Automatic installation which is the easiest way of Ubuntu installation can be selected by the first option "Install Ubuntu alongside Windows 10". In our case manual installation mode –

option "Something else"- was preferred, so all the parameters relating to the partition, and also the installation and boot files on disk can be set (Figure 4.3). In case that user has no experience with Linux software, and more generally with operating system software installations, this option is preferable to avoid because of the complexity in relation to the first option.

Figure 4.3 Create partition for Ubuntu

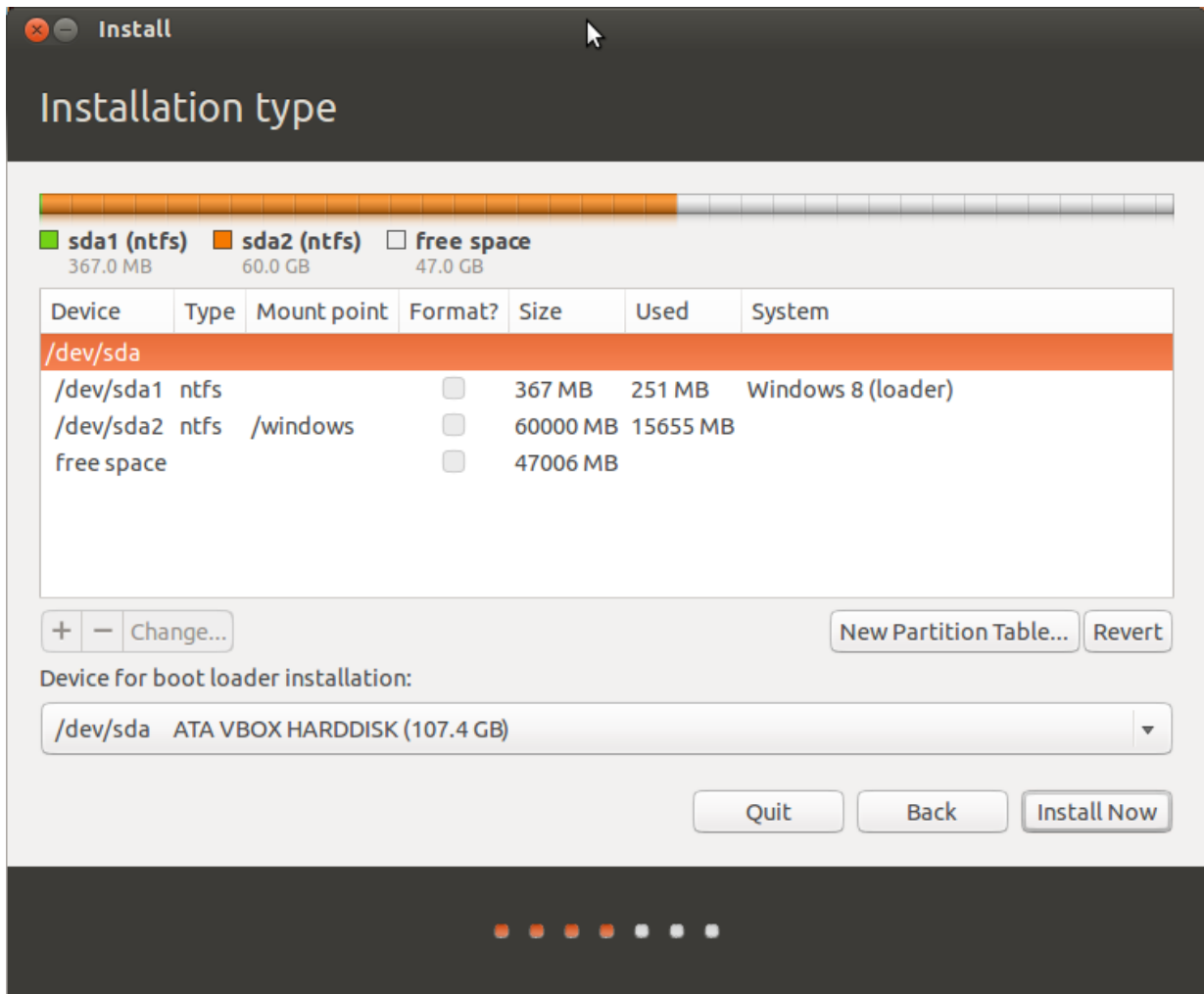

The version of Ubuntu that initially chosen and installed was 32-bit, since for the communication of the spectrum analyzer with the PC, VISA of National Instruments in combination with PyVISA was used, and there was an issue of compatibility in 64-bit Ubuntu version, as will be explained in following subchapter. Later, in the final form of application, the

PyVISA-Py in place of NI-VISA was used, which had no compatibility issue, and thus Ubuntu 14.04 LTS was reinstalled, this time at 64-bit version.

Having completed the installation and the necessary software settings, an Internet connection became to install the necessary programming languages and libraries, which are all free and open source software.

4.5 Python programming language and Spyder IDE environment

For development of EMF exposure measurement software, Python [60] was chosen. It is a widely used high-level programming language for general-purpose programming, created by Dutch Guido van Rossum and first released in 1991. Python has clear syntax in combination with major power, while it is a very expressive language. This means that enables the developers to express concepts in less lines of code than would be possible in other respective languages like Java, C ++ etc. Python is distinguished for the variety of libraries possessing, but also for the occupancy, productivity, efficiency and scalability and uses modules, classes, exceptions, as well as high level dynamic data types. The scalability of this language can be done by adding new modules implemented in other programming languages such as C or C++. All these modules can define new functions and variables as well as new object types. In general, the Python can be used to develop various applications on domains such as internet, system management, text file processing, education etc., and can be installed in most operating systems (Windows, Linux, Unix, Mac OS, etc.) [61].

Until 2000, python versions were under the Python License, which was incompatible with the GPL. Unlike the GPL, the Python license is not a copyleft license, and allows modified versions to be distributed without source code [62], [63]. The newer versions are governed under the Python Software Foundation License which is BSD-type and compatible with the GNU GPL [64] . Thus, python version 1.6.1 is essentially the same as Python 1.6 with a different license that enables later versions to be GPL-compatible. All of the above combined with that Python language is free and open source software contributed to the selection of that language

for implementing the presented EMF exposure measurement software. Being free and open source language, it is possible to distribute copies of and to edit the source code of, even use parts of it in new free programs.

The version of Python that was initially used was the Python 3.4 on 32-bit, however after installing the 64-bit Ubuntu, the version of Python 3.5 on 64-bit ultimately preferred. The development environment (IDE) installed for the use of Python is the Spyder 2 and in particular the version 2.7, which is available free online. Spyder is an interactive development environment Python and provides features similar to the MATLAB while being simple and lightweight software. This IDE is also offers Python widgets to implement application with the libraries PyQt5 and PyQt4, source code syntax field with syntax highlighting, Python console and other features while offers numerical calculations environment due to IPython support and popular libraries like NumPy for linear algebra, SciPy for signal analysis and image, or Matplotlib for graphical 2D/3D representations. The figure below (Fig. 4.4) shows the environment Spyder during the process of implementing the application code.

Figure 4.4 Develop of the application in Spyder IDE environment

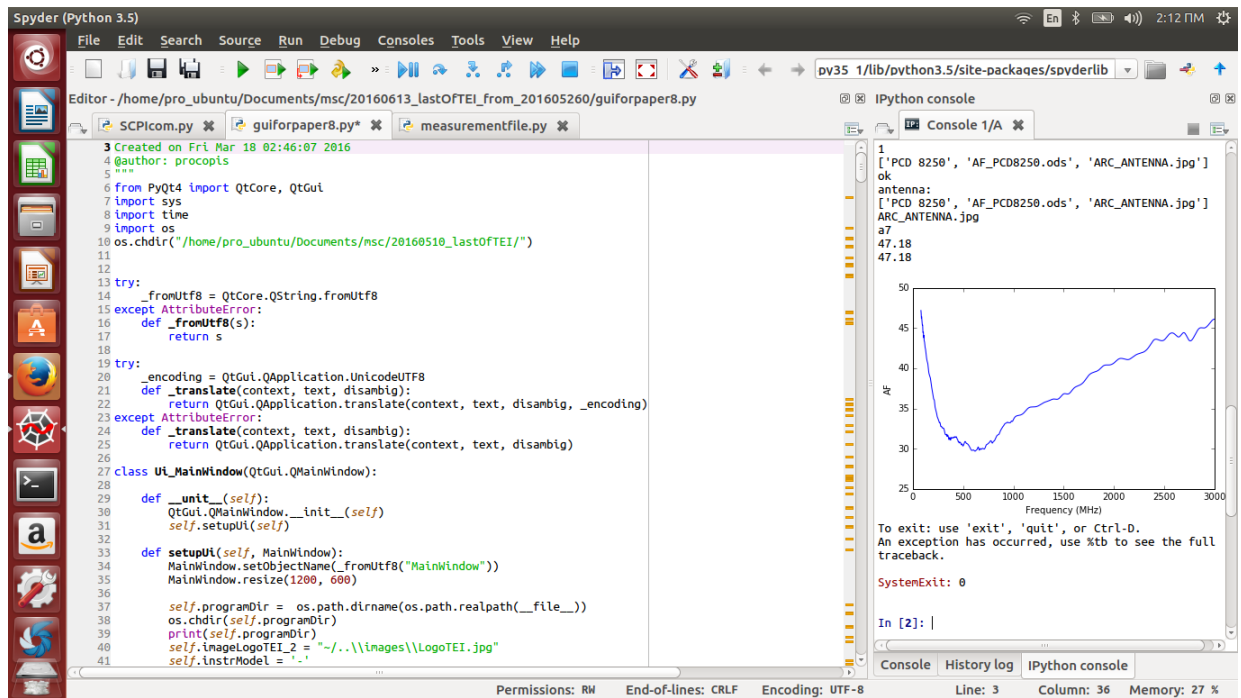

4.6 Virtual Instrument Implementation Standard (VISA)

For the interface of the presented software with spectrum analyzer, the use of a VISA library is required. The VISA acronym derived from the words Virtual Instrument Software Architecture which is a widely used I/O API. The industry VISA standard has the advantage that it can be used for the configuration, programming and troubleshooting instrument systems regardless of the interface type. For example, VISA command which sends an ASCII phrase in a measuring instrument is the same regardless of whether the interface of the instrument is (GPIB, VXI, PXI, Serial, Ethernet or USB). This standard provides the programming interface between the application development software and programming languages such as LabVIEW, Microsoft Visual Studio, Matlab, Python, C, etc., and the instrument, and also applied by various test and measurement (T & M) companies as Anritsu, Bustec, Keysight Technologies, Kikusui, National Instruments, Rohde & Schwarz and Tektronix. Therefore, this standard provides to the developers an easily programming of the instruments with different interfaces through a common language.

Initially the NI-VISA for Linux systems, which is the implementation of the VISA I / O standard of National Instruments was selected to be used. NI-VISA is offered on the Web in versions for MAC OS X, Microsoft Windows and Linux operating systems [65]. However, the installation of NI-VISA in combination with the Python programming language requires special attention, because the version of Python should be in the same with the NI-VISA version, whether 32-bit or 64-bit. For this reason it is recommended to firstly install the version of VISA for the operating system that the computer already has, and then based on this, the equivalent 32-bit version or 64-bit of Python should be installed. The version of NI-VISA used, was the NI-VISA for Linux systems which is offered in 32-bit version combined with PyVISA. Thus, the programming language that was initially installed was Python 3.4 on 32-bit. During program execution, communication of the software with spectrum analyzer by using the NI-VISA was completely successful.

Alternatively, the NI-VISA, the communication of the instrument with the software, can also be achieved through the use of PyVISA-py library [66]. The PyVISA-py is a backend for PyVISA that is designed for instruments communication using the Python programming

language, and is available free online. This library implements most of the methods used to communicate the Python with the instrumentation interfaces via Serial, USB, GPIB and Ethernet. An example of instrument connection using Python code and PyVISA-py is presented in the following figure (Figure 4.5).

Figure 4.5 Instrument connection using Python and PyVISA-py

```
>>> import visa
>>> rmm = visa.ResourceManager('@py')
>>> rmm.list_resources()
('USB0::0x1AB1::0x0588::DS1K00005888::INSTR')
>>> inst = rmm.open_resource('USB0::0x1AB1::0x0588::DS1K00005888::INSTR')
>>> print(inst.query("*IDN?"))
```

In this code example, we notice that initially the visa library is introduced. Then through the constructor Resource Manager, type of library is specified. In this case the "*@py*" corresponds to PyVISA-py. In the previous case, which NI-VISA had been used, in the position of "*@py*" was the "*/pathToVisaFile/libvisa.so.7*". Both the NI-VISA and the PyVISA-py are backend of PyVISA. This means that to achieve the interconnection of the instrument to the PC is necessary the existence of either of two backend, and also the frontend of VISA library the PyVISA. The PyVISA is designated as a Python package that allows the control of different types of measuring instruments supporting different types of interfaces such as (RS232, USB, GPIB, Ethernet, etc.).

In the above image (Figure 4.5), at the third line of code, the command used is requesting the list of the connected interfaces, and as distinguished from the response, a measuring instrument attached to USB0 interface already exists. Then, the statement of the instrument in the variable "*inst*" follows. Finally, the SCPI command [67] which is asking the spectrum analyzers data (such as model, type etc.) is sent. More about SCPI commands will be presented in the following subchapter. The PyVISA is available on the Web without any cost, is governed by the MIT Licence since version 1.3 and can be used on Linux operating systems, MAC OS X and Microsoft Windows. The PyVISA version that installed and used for the interconnection of the

PC with the spectrum analyzer was initially PyVISA 1.6 which was then upgraded in PyVISA 1.8.

4.7 Standard Commands for Programmable Instruments (SCPI)

For the communication of this thesis software with the spectrum analyzer, SCPI commands are used. The SCPI provides a standard for syntax commands to control programmable test and measurement devices. This standard was created in 1990 as an additional level of IEEE 488.2 specification and defines a common syntax, command structure, and data format so that it can be used by various types of measurement instruments. The SCPI standard consists of general commands, for example “*CALCulate:*” or “*DISPlay:*” and then subcommands are following, as “*CALCulate:DATA*” for reading or writing of measurement data or memory data and “*DISPlay:WINDow:TRACe:DATA*” for reading or writing data to the instrument display. More generally, SCPI commands used either to perform a number of functions or a query operation, for example to read the value of a voltage. To perform a query operation a semicolon “?” is added to the end of the command. For example, the command that returns the current time of the instrument is “*SYSTem:TIME?*”. The SCPI standard has been structured in such a way that similar commands have the form of a tree. Thus, any command for measuring, will begin with the prefix “*:MEASure*” and then subcommands as “*:VOLTage*” and “*:DC?*” will follow. The command “*:MEASure: VOLTage: DC?*” for example asks the DC voltage of the instrument. Figure (4.6) below presents the relevant commands as a tree format.

Figure 4.6 Tree format of SCPI commands for measuring instruments voltage and current

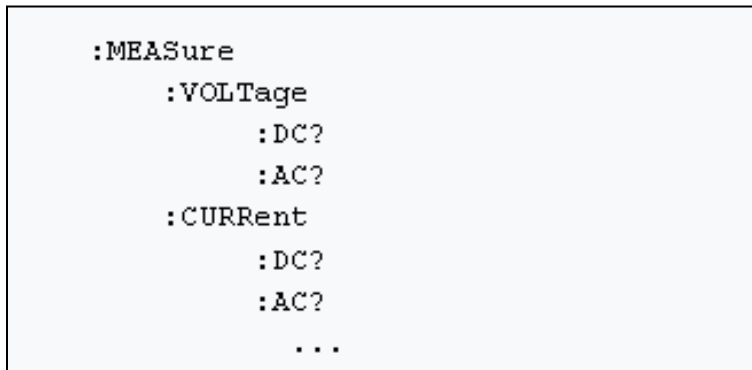

The SCPI commands can be in one line. This occurs if a Greek question mark placed between different commands. For example if in addition the DC voltage we wanted to measure also the alternating current, we could write in line the following command “*MEASure:VOLTageDC?::MEASure:CURRent:AC?*”. Character “:” that appears at the beginning of a command specifies the command root. If the specific character is not entered at the beginning of the command, then reference to the last node is made. Thus, command “*:SOURce:FREQuency:STARt 100::SOURce:FREQuency:STOP 200*” can be written as “*:SOURce:FREQuency:STARt 100;STOP 200*”. It is observed that some characters are in uppercase while others in lowercase. Characters in block indicate that is necessary in order to perform the command while the characters in lowercase are optional. Therefore, the previous command could also be written as “*: SOUR: FREQ: STAR 100; STOP 200*”, having the same effect. The SCPI was originally created for the IEEE-488 i.e. GPIB interface but today this standard can also be used with RS-232 interface, Ethernet, USB VXibus, HiSLIP etc.

The software implemented through this thesis uses SCPI commands for global settings of the spectrum analyzer, such as date and hour of measurement, settings of measurement parameters (Start and Stop Frequency, Video Bandwidth, Resolution Bandwidth, Attenuation, Reference Level, Sweep Time, etc.), for carrying out the measuring process and also to transfer the data to the computer for further processing. For the communication of spectral analyzer with PC and software, more than thirty different SCPI commands are used.

4.8 PyQt Graphical User Interface widget tool

For the implementation of the presented software great effort had been made so as to give the final user a very friendly Graphical User Interface (GUI). To implement the graphical interface, PyQt was used. PyQt is a Python binding of the cross-platform GUI toolkit Qt [68]. PyQt is a blend of Python programming language and the Qt library. In addition to Linux platform, the PyQt also supports all recent versions of Windows, Mac OS X and most of the Unix-based systems. The management of an application that has been implemented in an operating system

from the previous ones, can be also achieved to the rest supported operating systems without requiring any different compilation, thanks to Python being interpreted, and no source code modifications for adapting to a different platform is necessary thanks to Qt features, if Python and PyQt are both installed.

Figure 4.7 Source code for simple window creation by using Python and PyQt4

```
import sys
from PyQt4 import QtGui
def window():
    app = QtGui.QApplication(sys.argv)
    w = QtGui.QWidget()
    b = QtGui.QLabel(w)
    b.setText("Hello World!")
    w.setGeometry(100,100,200,50)
    b.move(50,20)
    w.setWindowTitle("PyQt")
    w.show()
    sys.exit(app.exec_())

if __name__ == '__main__':
    window()
```

This widget tool is used to develop GUI applications of all kinds. A lot of commercial applications from accounting applications to visualization tools used by scientists and engineers are based on that. Similarly to Python, PyQt, and Qt can be used free of charge for noncommercial purposes. Nevertheless, Python license allows the developing of both commercial and noncommercial applications, but are both PyQt and Qt are dual-licensed. This essentially allows them to be used to develop noncommercial applications—which must in turn be licensed using an acceptable open source license such as the GNU General Public License (GPL); or to be used to develop commercial applications—in this case, a commercial PyQt license and a commercial Qt license must be purchased [69]. To download and install PyQt

version 4 on Linux system, “*apt-get*” command with the syntax “*sudo apt-get install python-qt4*” must be executed. The examples are shown in figures 4.7, 4.8 and 4.9, represents the source code needed to create a simple window that includes the text "Hello Word" and also to create a file dialog that load its file contents respectively, by using Python and PyQt4

Figure 4.8 Source code for a file dialog that load its file contents by using Python & PyQt4

```
#!/usr/bin/env python
# -*- coding: utf-8 -*-
#
import sys
from PyQt4.QtGui import *

# Create an PyQT4 application object.
a = QApplication(sys.argv)

# The QWidget widget is the base class of all user interface objects in PyQt4.
w = QWidget()

# Set window size.
w.resize(320, 240)

# Set window title
w.setWindowTitle("Hello World!")

# Get filename using QFileDialog
filename = QFileDialog.getOpenFileName(w, 'Open File', '/')
print filename

# print file contents
with open(filename, 'r') as f:
    print(f.read())

# Show window
w.show()

sys.exit(a.exec_())
```

Figure 4.9 Result of “figure 4.8” source code

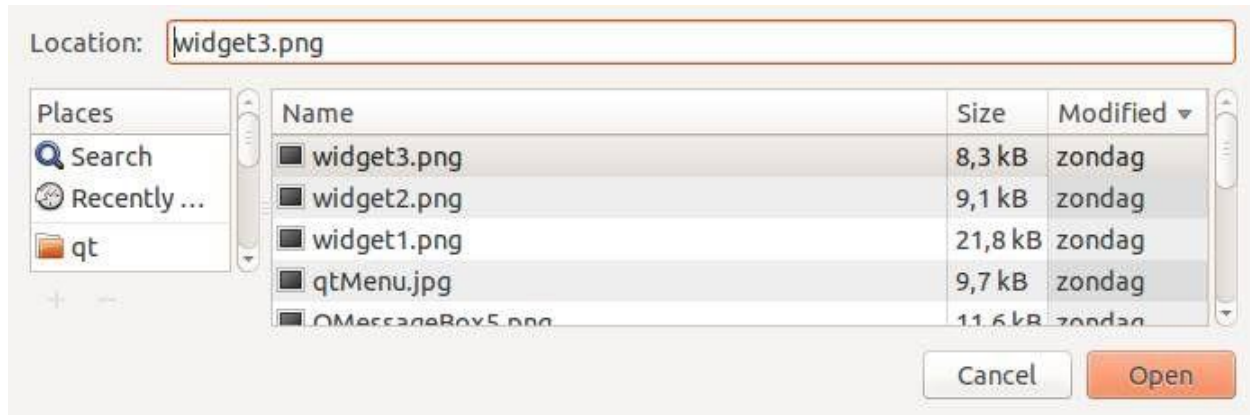

4.9 Software applications for automating EMF measurements

Software applications for automating EMF measurements have been developed, mainly using closed-source and commercial software tools (e.g. Matlab, LabView), and may provide simplicity and usually a friendly user Interface [70], [71]. Such software tools are either offered with the buying of costly instrumentation, or they are usually quite expensive both to be purchased or for being upgraded, without giving the ability to the user to control the whole process (measurements and/or evaluation of the results).

On the other hand, free and open source software usually has zero cost and offers the ability to control its operation. Nevertheless, the implementation of open source software similarly with commercial software may consists of complicated processes, since it requires the correct choice for type and versions among various programming languages, libraries and modules that should be used in order to collaborate in harmony. The presented software is developed exclusively using free and open source software tools and provides graphical user interface, usability, reliability and also convenience for upgrading.

Table below presents a brief comparison with others software developed for automating EMF measurement process.

Table 4.1 Software for automating EMF measurement comparison

Software	Software for R&S Instruments	Virtual Instrumentation System (VIS)	NIRL existing software	Presented Software
Software Tool	Matlab	LabView	Visual Basic	Python
OS	Windows	Windows	Windows	Ubuntu (Linux)
VISA	Agilent VISA	NI-VISA	Agilent VISA	PyVISA
Instruments	R&S SA's Oscillators , Generators	SA R&S FS300	SA R&S FSH8 , ESA-E4407B , Field Meter PMM 8053	SA – R&S FSH4, R&S FSH8 , ESA-E4407B and others SA's if updated
Evaluation	No	Yes	Yes	Yes
Compare with limits	No	Yes	Yes	Yes
Update ability	No	No	No	Yes
Report Creation	No	No	Yes	Yes

Chapter 5 - Software Presentation

5.1 General Remarks

The main purpose of this master thesis is the design and the develop of open source software, which in operation with Spectrum Analyzers fully automates the electromagnetic radiation measurement procedure at multiple frequency fields as UMTS, GSM, Wi-Fi, TETRA, etc. This application was developed based to open source and free software, libraries and modules that presented in the previous chapter. It contains default settings adapted to these frequency bands. User has the ability to customize the measurement setting according to his personal requirements.

In addition, selections of different types of antennas, cables and spectrum analyzer models which adopt the SCPI standard are allowed and new elements can also be imported with a simple update. Also, storage of measurement data for their further processing and comparison with the protection limits can be enabled. Furthermore, a relevant report with the results and conclusions of the measurements made can be generated. Figure 5.1 presents the main screen of the developed software. Basic options, settings and functions are presented in this chapter.

Figure 5.1 Main Screen of the presented application in Ubuntu environment

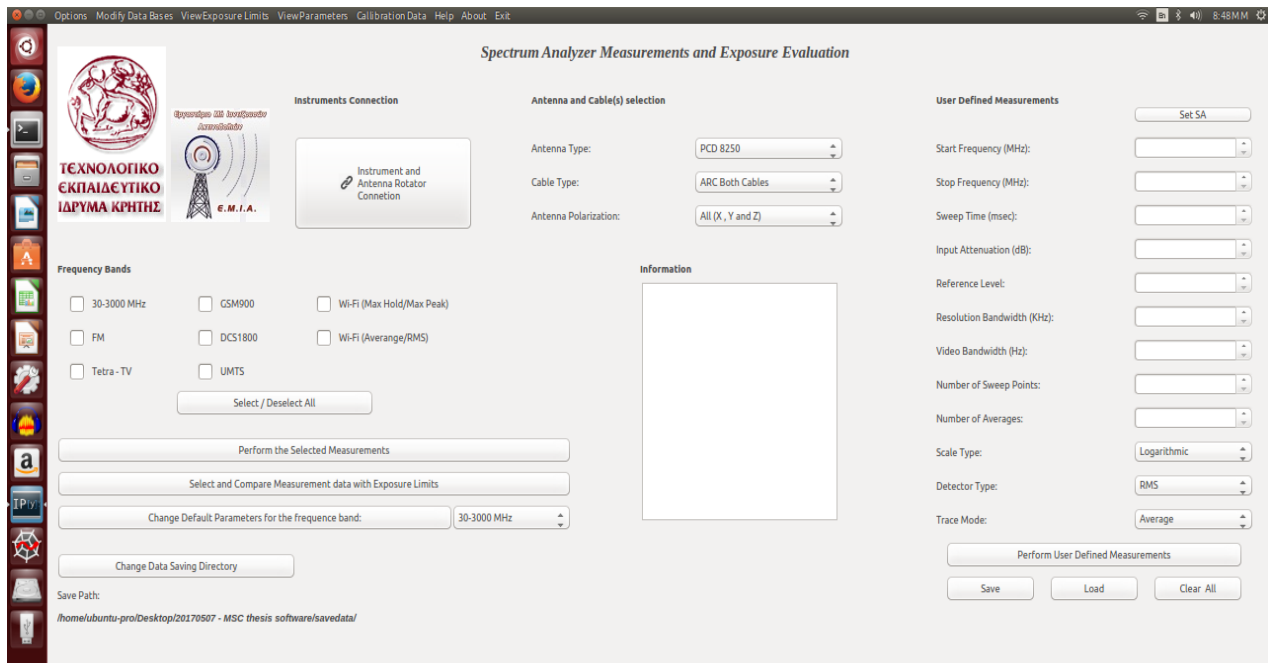

5.2 Antenna and Cables selection

This Prior to any other operation, the user must have set the antenna and the cable that will be used for the measurements. This is necessary because these parameters have an important role in the connection of the software with the measurement instruments and also in the correct way to receive and process the results of measurements. Through the software, the choice of various types of antennas e.g. PCD8250 and various cables such as ARC Both Cables is available. The data relating to antennas and cables are stored in the folder "databases" and specifically in spreadsheet files "antennas_database.ods" and "cables_database.ods". The user can update this database by adding or removing data. It can even upgrade the existing data on antennas and cables with new ones. This process is discussed later.

Sometimes the user may want to measure signals in a certain direction of the used antenna. Therefore, user through this software has the ability to select the receive direction of the measure he wishes. Options in such cases are X or Y or Z axe as well as "All axes" (X, Y and Z). In the last case, if an isotropic antenna does not exist, for the rotation of the antenna from axis to axis, a rotating antenna is used. As we will see in the next chapter with real measurement examples, antenna rotation is performed automatically from the software by sending serial commands via USB port that antenna is connected with the PC that runs our software. The selection of receiving antenna model and orientation, and also the selection of cables type that are used for the measurement, becomes from the field "Antenna and Cable (s) selection that is located at the center of the initial software screen.

Figure 5.2 Antenna and Cable(s) selection field

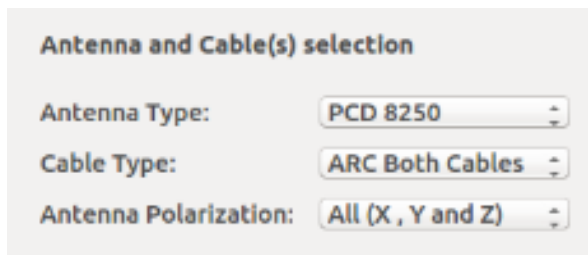

Antenna and Cable(s) selection

Antenna Type: PCD 8250

Cable Type: ARC Both Cables

Antenna Polarization: All (X, Y and Z)

5.3 Connection with the Spectrum Analyzer

After assembling the measurement equipment, and before any other action by the software, the application must be connected with the measurement instrumentation. This is necessary for the communication of the software with both the spectrum analyzer and the receiving antenna, to perform EMF measurements. Connection with the spectrum analyzer is made by the button “Instrument and antenna connection” which is placed in the field “Instruments Connection” of the home screen. By pressing this button, the relevant window appears, which includes choices concerning to the type of connection (TCP, GPIB), the number of the COM port that antenna is connected (this option is enabled only if rotating antenna e.g. PCD8250 is selected from the main screen), the spectrum analyzer’s IP Address (this option is enabled only if TCP connection type is previously selected) and GPIB address (this option is enabled only if GPIB connection type is preselected). Furthermore, an indicative figure shows the cable is displayed, and also the button "Connect" which activates the connection process with the spectrum analyzer and the receiving antenna. Figure 5.3 presents the “Instrument Connection Window”.

Figure 5.3 Instrument Connection Window

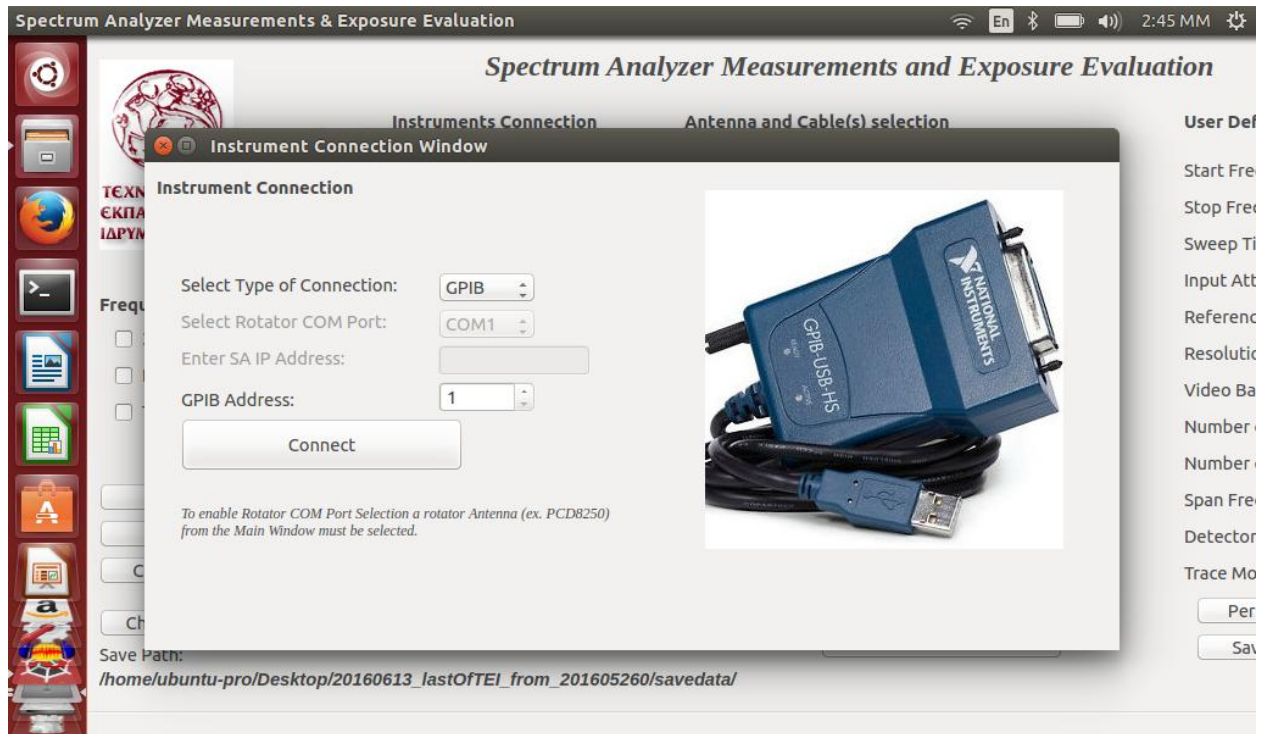

For the connection of the software and the spectrum analyzer, “instrumentConnection()” function is applied (figure 5.4). If for any reason connection is not possible, an error message appears on the main screen of PC. The connection is made through PyVISA-py for the spectrum analyzer and py-serial library for the antenna rotator.

Figure 5.4 Python code for SA and antenna rotator connection using PyVisa

```
7 def instrumentConnection(self, address, port):
8     import visa
9     import re
10    import os
11    import serial
12
13    os.chdir(self.programDir)
14    rm = visa.ResourceManager('@py')
15
16    if self.icwcomboBox_2.currentText() == 'TCP':
17        instrumentName = 'TCPIP0::'+address+'::inst0::INSTR'
18    else:
19        instrumentName = 'GPIB0::'+address+'::INSTR'
20
21    try:
22        myinst = rm.open_resource(instrumentName)
23        print("connected")
24    except(visa.VisaIOError):
25        print("connection error")
26        self.noConnectionFunction
27
28    myinst.write("*CLS")
29    myinst.write("*IDN?")
30    Instrument_string = myinst.read()
31    [Manufacturer,Instrument_Model, Instrument_Serial_Number, Firmware_Version]=re.split(
32        "[,]",Instrument_string);
33
34    print("\n Manufacturer: " + Manufacturer)
35    print("\n Model: " + Instrument_Model)
36    print("\n Serial Number: " + Instrument_Serial_Number)
37    print("\n Firmware version: " + Firmware_Version)
38
39    ser = serial.Serial(port,9600,timeout=10)
40    ser.close()
```

Afterwards, common basic SCPI commands are used for identification of the model and type of the spectrum analyzer. Through these commands the present spectrum analyzer is recognized and the answer is its manufacturer, model, serial number and firmware version. This information, as well as the result of the connection procedure displayed into the information box located at the center of the software’s main screen (figure 5.5).

Figure 5.5 Information of spectrum analyzer and the antenna rotator connection result

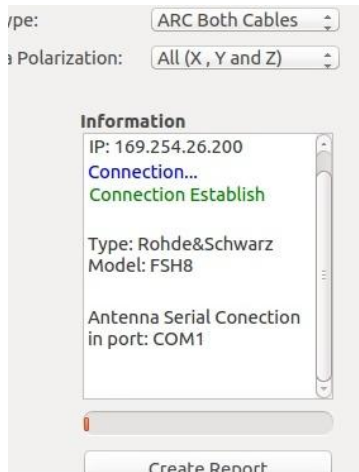

Assuming that the connection between SA and remote control software is established with TCP/IP protocol via an Ethernet cable, the user is initially requested to introduce the IP address of the SA which will be used for carrying out the measurement (this IP address can be found for example from the setup menu of the used SA). Once connected, using specific SCPI commands, the information about the brand and the model of the SA will be displayed in the “Information frame” of the GUI. Automatically, specific commands for the particular SA will be selected and loaded from the application's database, of course if for the model of SA, a respective database exists. Following the successful connection and identification of SA, the user can choose from a variety of options. Some of these options are described in the following paragraphs.

5.4 Perform measurements with default parameters

Measurements can be performed both with predetermined parameters and with parameters that can be entered by the user. The "Frequency Bands" field contains a range of bands at frequencies from 80MHz to 3000 MHz with predefined parameters which are most appropriate for measurement at each separate band respectively. These bands are FM, Tetra-TV, GSM900, DCS1800, UMTS and Wi-Fi. The parameters mentioned above are located in

spreadsheet "dataBaseFile.ods" file at the folder "databases". Each time a measurement at a specific band starts, respective parameters of this band are imported. The user can select some or all of the bands that offered, and begin the process of measurement by pressing the button "Perform the Selected Measurements". Figure 5.6 presents the "Frequency bands" filed. The button "Perform the Selected Measurements" is located below.

By using the button "Perform selected measurements", the process of performing measurements for bands that have been selected begins. The software checks the parameters that are set and refer to the type of antenna, cables, direction of the antenna, type and model of the spectrum analyzer and frequency bands that have been selected to be measured. Based on the previous, appropriate parameters are loaded from the corresponding libraries that contain them. More particularly, when this button is pressed the function "checkBoxState()" is activated. This function is built to check the status of checkboxes, and identify which frequency bands are chosen for the measurement. This function is based on a repeating loop that controls one by one if checkboxes are checked, and if so stores the corresponding band in the variable "frequencyBand". Then the "measurement()" function that begins the measurement process for the selected bands, is activated.

Figure 5.6 Frequency Bands Selection

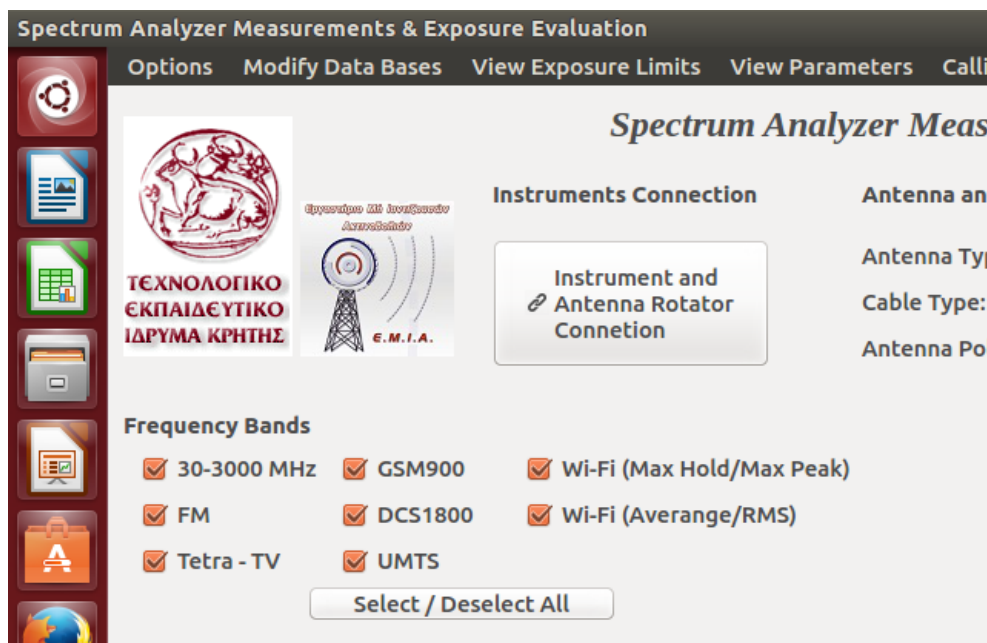

Function “measurement() ” is included in the file "measurementfile.py" in the root folder of the program and has been created to take over all the basic processes that is need to be performed by the software for carrying out the measurement. With the execute of this function, the visa libraries time, re, os, as well as libraries “pyexcel_ods3” and “pyexcel” which are used to retrieve from the database the relating to measurements parameters, are imported. More particularly, from open source spreadsheet file “dataBaseFile.ods”, the column that refers to the selected frequency band is loaded. This column includes the parameters Start and Stop Frequency, Sweep Time, Resolution Bandwidth, Video Bandwidth, Number of Sweep Points, Number of Averages, Scale Type, Detector Type and Trace Mode.

For conducting the electromagnetic radiation measurement, the methodology and the mathematical calculations referred to in section 3.2 and 3.3 respectively, are used. To achieve this, the function “Set_measurement()” has been implemented, which is called just after the setting of the attenuation and the reference level. In order to set the attenuation and the reference level as mentioned above, “attenref()” function is used. This adjustment is made to protect the spectral analyzer, but also for better visualization of measurements on the spectrum analyzer’s display. This function is included in the file “measurement.py” and its operation is based on scanning of the selected frequency spectrum that corresponds to the measuring band, to locate the max peak of the trace. After, depending on its value, it sets the Attenuation and Reference Level. For example, if the max peak is calculated that is less than -80 dB and greater than -90 dB, the Attenuation value is set to zero while the Reference Level is set to -70 dB just above the Max Peak of Trace. If reception carried out in all three directions (X, Y and Z), then the setting of attenuation and reference level carried out based on the largest max peak of these three axes. Essentially, this function locates and returns the appropriate values for Attenuation and Reference Level, while their setting on the spectrum analyzer is made later with the function “Set_measurement”.

After calculating the values of attenuation and reference level, the function “Set_measurement” is executed. This function sets all the necessary parameters in the spectrum analyzer according to its model and type by using the respective SCPI commands. Besides of the parameters Attenuation and Reference Level that are calculated, the default parameters Start and Stop Frequency, Resolution Bandwidth, Video Bandwidth, Sweep Number of Points, Sweep

Time, Detector Function, Trace Mode, Scale Type and Number of Trace Averages for each frequency band are loaded from the file “database.odt” and can be easily changed from button "Change Default Parameters for the frequency band", for each respective band that is chosen from the next drop-down menu as seen in figure 5.6. This process will be discussed in following subsection.

Figure 5.7 Measurement data at FM frequency saved on ods spreadsheet file

	A	B	C	D	E	F
1	Frequency (Hz)	Trace1 (dBm)	Information			
2	80000000	-107.0288772583	Attenuation (dB)			
3	80047619	-107.0288772583		0		
4	80095238.1	-109.7884368896				
5	80142857.1	-107.1686859131	Center Frequency (Hz)			
6	80190476.2	-106.9663391113		95000000		
7	80238095.2	-108.9727401733				
8	80285714.3	-107.9993209839	Date/Time			
9	80333333.3	-109.1040878296		13/10/2016 15:38		
10	80380952.4	-108.6687927246				
11	80428571.4	-107.8065490723	Instrument Model			
12	80476190.5	-108.2337341309	FSH8			
13	80523809.5	-108.6874313355				
14	80571428.6	-105.8264160156	Span Frequency (Hz)			
15	80619047.6	-108.0725097656		30000000		
16	80666666.7	-107.8699874878				
17	80714285.7	-108.2311935425	Reference Level (dBm)			
18	80761904.8	-107.9170379639		-40		
19	80809523.8	-107.8758621216				
20	80857142.9	-107.9910354614	Resolution BW (Hz)			
21	80904761.9	-108.5380249023		100000		
22	80952381	-108.1754760742				
23	81000000	-108.308380127	Scale Type			
24	81047619	-108.455291748	LOG			

After the spectrum analyzer’s configuration with the parameters that mention above, the function “sPut2Excel” is called which assumes to read the defined parameters and also the captured trace data from the spectrum analyzer, and then to enter them into a spreadsheet file of “ods” type. This file is stored in folder with name that corresponds to the date and time the measurements were performed, while the file name corresponds to the measured frequency band. For example, if the measurement was made on date 27/10/2016 at time 15:58, and the frequency

band that has been measured was the FM band at 3 axes, the folder “20161027_1558” and the data files “FM_X.ods”, “FM_Y.ods” and “FM_Z.ods” for each axis respectively will be generated. These spreadsheet files are containing in the first column the frequencies in Hz, in the second column the Trace in dBm and in the third column important data such as model and type of the spectrum analyzer, date and time of the measurement, measurement parameters that used and other important information. Figure 5.7 above presents an “ods” file from a measurement that carried out at X polarization of FM band.

5.5 Change default parameters for any frequency band

As mentioned in the previous subsection, the software contains predefined parameters for each frequency band separately. These parameters can be easily modified and stored again as default parameters, with the following procedure. Initially from the drop-down menu beside the Button “Change Default Parameters for the frequency band”, the frequency band that we want to change the parameters must be selected. Then, from the previous button, the window “Change Default Parameters Mode” is displayed (figure 5.8).

Figure 5.8 Change Default Parameters Mode Window

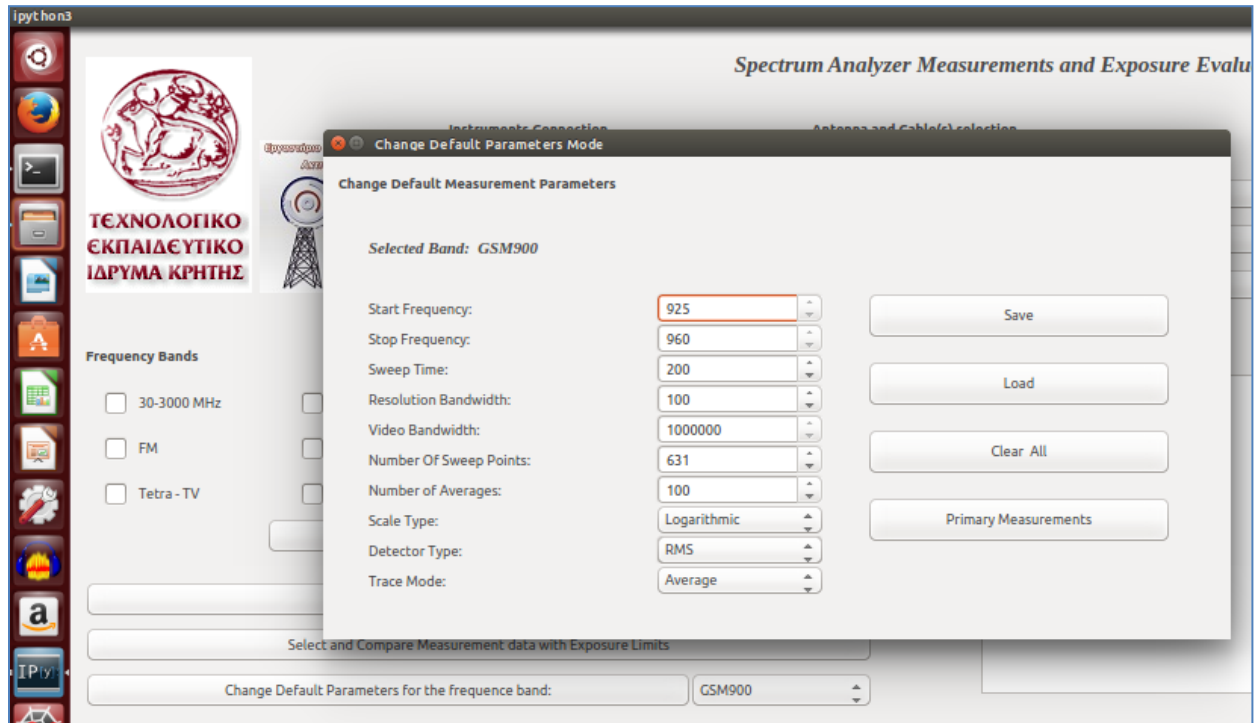

By opening this window, the Change Default Measurement Parameters field is displayed, which indicate the selected band at the left-top area, and includes the edit boxes where the desired new default parameters can be entered. These parameters can be stored into the spreadsheet file “databasefile_new.ods” that is located in the software’s database folder by using the “Save” button. Thus, by performing measurements at default frequency bands, these new parameters will be used. The application enables the recovery of other user defined measurement parameters from the "Load" button, and also stores them as default parameters. Moreover, any unsaved values can be cleared via the “Clear” button. Finally, if the user desires to return the default parameters that have been originally set by the software, this is possible by pressing the button “Primary Parameters”. These data are included into the file “dataBaseFile-original.ods” which should not be deleted or modified in any circumstances and for any reason.

5.6 User defined measurements

In addition to the predefined parameters and bands of the measurements that referred above, the user can insert directly the parameters that want to measure. This is very helpful in case the user wish to perform a specific measurement without changing the default settings of the software. Of course, the software takes into account the maximum and minimum values that each parameter can get. The user can enter the Start and Stop frequency in MHz, Sweep time in milliseconds, Input Attenuation in dB, Reference Level, Resolution Bandwidth in KHz, Video Bandwidth in Hz, Number of Sweep Points, Number of Averages, Span Frequency in Hz, Detector Type (RMS, Max Peak, Min Peak, Sample and Auto Peak) and Trace Mode (Average Mode, Max Hold, Min Hold and Clear / Write). The frame where the user can import the desired parameters is located on the right side of the main screen of the application and more particular in the field "User Defined Measurements". Furthermore, by moving the cursor to the corresponding input field of the parameter value, the software displays the range of values that the specific parameter can receive. It should be noted that if the value of any parameter entered by the user is above or below the limit value, then the software stores the maximum or minimum value respectively that this parameter can have.

This function provides a satisfactory parameterization of the spectrum analyzer according to the user's wishes. All the above values can be stored in spreadsheet ods files and can be retrieved for later use by the user. The files are stored in the default folder "userPerformedMeasurements" located in the root folder of the software. By pressing the button "Save" a window titled "Save File Name" opens, where user is requested to input a name for storage file. Next, by pressing the "OK" button, the numeric date and time in the form "YearMonthDate_HourMinute_" is added at the beginning of the name declared by the user, and the file is saved with suffix "ods". For example, if the operator during the storage of user defined measurement parameters, enter the name "userdefinedmeasurements" and the current time and date is 15:52 of 01/11/2016, the file "20161101_1552_userdefinedmeasurements.ods" will be created and saved in "userPerformedMeasurements" folder. Information regarding the confirmation of the storage as well as the name of the generated file will be also appeared in the information box at software's the main screen.

To retrieve parameters that has been previously saved, the user can press the button "Load" located under the import parameter field. Then, user automatically is transferred to the

folder that the files with the user defined parameters are located. By selecting one of these files, the corresponding parameters are loaded into the field “User Defined Measurements”, and so the user can perform measurements with these parameters or even to modify some of them before performing any measurement. The user can use the “Clear” button to clear all the entered parameters. All these fields are presented in figure 5.9.

Figure 5.9 User defined measurements menu

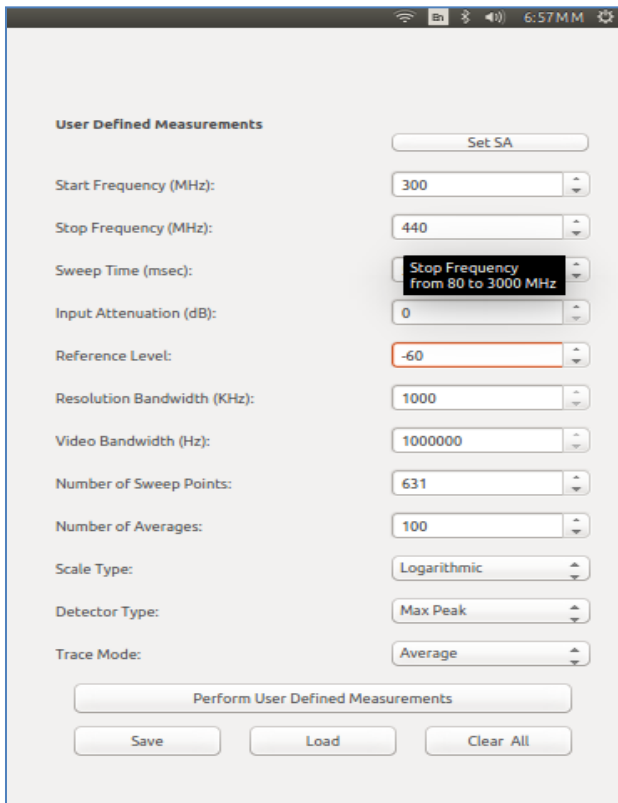

Since all parameters are entered, the measurement process can begin from the "Perform User Defined Measurements" button. Then, similar procedure to obtain measurements with default parameters that mentioned in subchapter 5.4 is followed. In case no parameter has been entered the software shows a warning message and does not allow measurement process to begin.

5.7 Storage of measurement captured data

The storage of measurement data is made after the completion of each measurement procedure. These files are stored in the folder “savedata”. The user is able to change the location of storage by using the button “Change Data Saving Directory”. Clicking on this button, a window from which the user can select the folder that the measurement data files will be stored, is displaying. In case the user closes the window without selecting any folder, the software stores the data at the folder that was predetermined. Inside the folder that is designated to store the measurement data, the software at the beginning of the measurement process, creates automatically a subfolder in which all files with measurement data will be stored. This subfolder derives its name from the current date and time, that measurement took place. Into this folder, an ods spreadsheet file is generated and stored, during the measurement process which contains the data of the captured trace, the frequency, and various other information.

For each individual axis is measured (X, Y, and Z), the corresponding “ods” spreadsheet file that contains the measurement data is generated. Furthermore, with the use of “screenshot()” “binblock_raw()” function that has been implemented, the software automatically captures a picture of the spectrum analyzer’s display for each axis during the measurement procedure, and stores it in the data storage folder in png format. The names of the generated “ods” and “png” files are associated to the frequency band and the axis that being measured.

As mentioned above for capturing the spectrum analyzer’s display and store data in a png file in the computer, two functions which have been developed for this purpose are used. Initially, the “screenshot()” function which performs the SCPI command that receives the image of the spectrum analyzer display in binary form, is executed. There is also the possibility of taking the data in ASCII format, but is not preferred since the download is slower, unless the spectrum analyzer does not support the download of data in binary form. Then, the “binblock_raw()” function is called, which decodes and returns the appropriate data that are required to generate the image. This data is stored in a file with a png extension. In this way the display of the spectrum analyzer during the measurement, is saved in the PC as a png image file.

5.8 Measurement analysis and comparison with the exposure limits

Besides performing measurements of electromagnetic radiation, and store the measurement data and other relevant information in spreadsheet files, the described software offers measurement analysis and evaluation of the results in terms of exposure. It calculates the estimation of exposure to electromagnetic radiation, displays relevant chart of the quantities that are required for the overall evaluation in relation to the frequency, and also the limit according with current legislation in Greece for the certain frequencies, as well as how many times the result is below the limit. In order to open the window, of processing and analyze the measurement data, as well as to calculate and estimate the exposure to electromagnetic radiation, we use the button “Select and Compare Measurement data with Exposure Limits”. By opening this window, text boxes with different frequency bands are displayed. In these text boxes the separation of files according to the frequency band that we wish to analyze is performed. The user is asked to select the folder in which the measurements he wants to process are stored, by using the button “Select Data Folder” which is located on the left area of this window. The measurement data files are automatically sorted in the corresponding text boxes depending on the frequency range that has been measured (FM, TETRA-TV, UMTS, GSM900, Wi-Fi, etc.).

Then the frequency band that user wants to evaluate the exposure to electromagnetic radiation must be selected. This is made by checking the respective check box above the text box of that band. By pressing the “Analyze” button, the process and calculation of quantities Power Density (S), Electric field strength (E) and Magnetic field strength (H) in the corresponding frequency band is carried out. The Exposure Factor that shows how many times the radiation is below the limit is also calculated. These calculations are performed according to mathematical analysis presented in subchapter 3.3.

After the data analysis, a corresponding message appears in the information text box that exist upper right side of the window. Thereafter, the user can select one of the three aforementioned quantities (S, E, H) and clicking on the button “Plot”, to display the diagram of the specific quantity versus frequency, as well as the RMS value of this quantity, the Exposure

Factor and how much below the limits is the specific measurement values. In that diagram, the limits for the selected measured quantities are also displayed. Thus, we can have an apparent estimation of the exposure to electromagnetic radiation in relation to the established limits. Moreover, useful options such as Zoom in and Zoom out, Grid on and Grid off etc. can appear by right-clicking on the diagram. The graphical depiction of the quantity versus frequency is displayed on the chart in a yellow line while the limit in a red line (Figure 5.10).

Figure 5.10 Chart of Power Density vs Frequency on FM band measurement

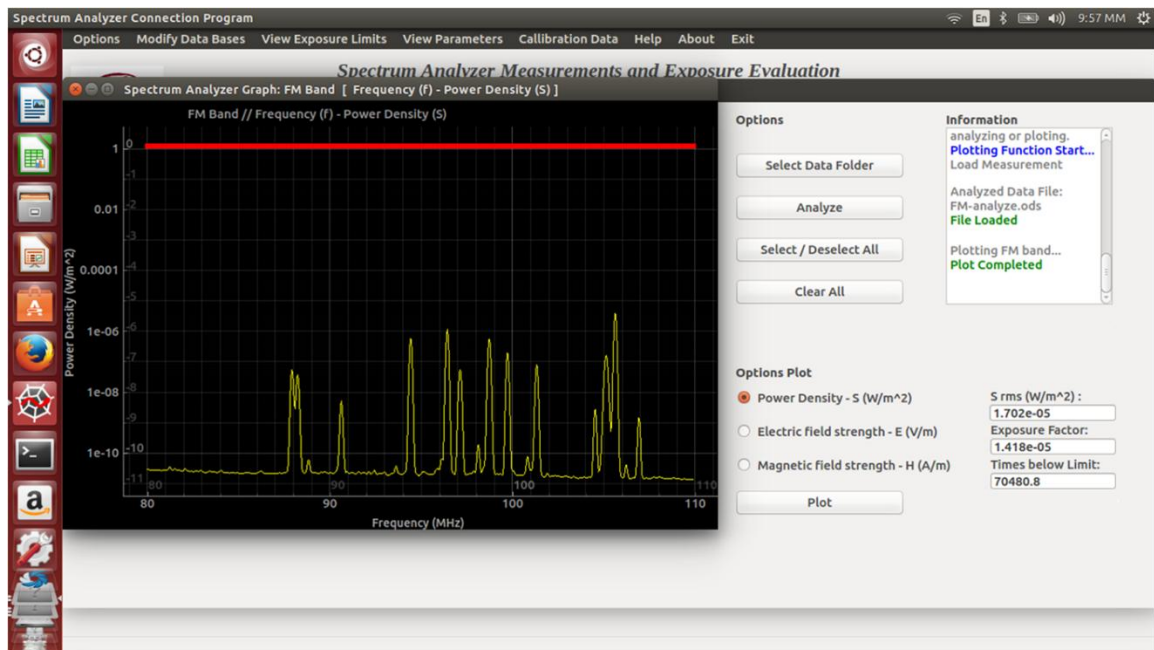

5.9 Generate the report of the measurement

The software has been developed with main focus on simplifying procedures and saving significant time for the operator's benefit. Therefore, the function "createReport()" has been implemented. This function is used to generate a report in a text file of "odt" type, which is supported by open source text editors like Libre Office, Open Office etc. and can be achieved forthwith after the analysis of the measurements, as previously presented. The generated report contains analytical results of the measurements performed, instruments and other components used, such as type and model of SA, antenna, cable(s) etc., as well as the settings and parameters

that were used. Additionally, the measurement results are presented and compared with the exposure limits.

Moreover, this report includes the screenshots from spectrum analyzer display which was automatically captured through the software during the measurements and stored in the respective measurement files, and also diagrams with the measured and calculated values. Furthermore, date and time of performing the measurements, as well as conclusions about the comparison of the results with the exposure limits are included.

5.10 Modification of Antenna and Cable's data

For proper evaluation of the measurement results, it is necessary to take into account both the losses of the connected cables and the antenna factor of the antenna. For that reason, corresponding functions have been created, which calculate the above. The data for both the antenna factor and the cable losses can be imported into the program, from the field “Modify Data Bases” at the top of the main screen menu. Assume we wish to add an antenna. First we must select the field “Update Antenna's Factor Calibration Data” and then we press “Insert Antenna” button that displays the relevant box on the screen. This window contains the options “Add Data AF File”, “Add Image of Antenna”, “Remove Data AF File”, and “Save Data AF File”, as well as a text input field where the user can enter the desired name of the antenna. Finally on the right side of the window there is a box which presents the names of the added data files, and the area where the antenna image is displayed. The antenna image addition is optional.

At this point, for the addition of the new antenna, we follow the procedure below. Initially, we press the button “Add Data AF File” and then we select the “ods” type data file of the new antenna. This file contains in the first column the frequencies and in the second the corresponding Antenna Factor as given by the antennas manufacturer. The software stores the antenna data to the “Calibration” folder into the database. The image addition of the antenna becomes from the button “Add Image of Antenna” where we choose the antenna image file that should be “jpg”, “gif” or “png” type. The name of the antenna is automatically filled, but also

offered the possibility of its alteration. Finally, for the antenna storage into the database, we click on button “Save Data Antenna File” and the antenna is added to the field “Antenna and Cable(s) selection” at the home screen, thus the new antenna can be used to obtain measurements. The button “Remove Data Antenna File” is used for deletion of the antenna data file. From the previous window “Update Antenna Data”, we can update an existing antenna with new data or even delete an antenna from the database and also from the “Antenna and Cable(s) selection” area. This is achieved after selecting the antenna from the relevant checkbox on the left side of the window and then by pressing the button “Update Antenna” or “Remove Antenna” for update and delete respectively.

Figure 5.11 Modify cable(s) data window

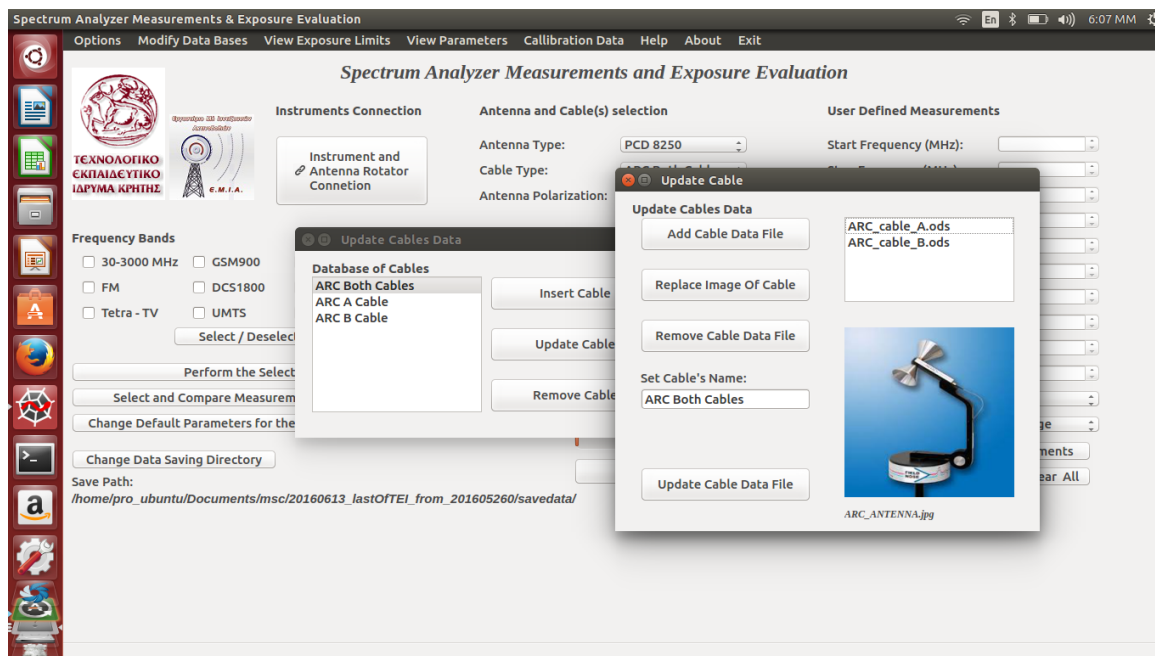

Identical process is performed for adding, updating or deleting a cable. The addition of the cable is carried out from the “Modify Data Bases” menu and then the “Update Cable's Calibration Data” option. It is noteworthy, that if two wires are used during the measurement, they may be added together to a selection into the software database. For example, in the

measurements that performed and analyzed in the next chapter, a PCD8250 antenna in combination with the Austrian Research Center (ARC) antenna rotator took place. For that, one cable for the connection of the antenna and the rotator, and also another cable for the connection of the rotator with the spectrum analyzer were used. These two cables were inserted in the software database as a single option of “ARC Both Cables”, by uploading the two data files (ARC_cable_A.ods and ARC_cable_B.ods - one for each cable) into the software database, and which were taken into account for the calculation of total losses. Figure 5.11 presents the window during the ARC Both Cables import procedure.

5.11 Computation of Antenna Factor and Cable’s Attenuation

After insertion of an antenna cables or to the software, the user can calculate and display the Antenna Factor diagram of the antenna but also for Cable(s) losses. This is carried out by selecting “View Parameters” from the main top menu, and then the option “View Antenna Factor” or “View Cable's Attenuation”. With this option, the corresponding window is displayed, where the user is required to select the name of the antenna or the cable, and then press the button “Display Antenna Factor”, or “Display Cable's Attenuation” respectively.

For the calculation of both the Antenna Factor and Cable(s) Attenuation, cubic linear interpolation is applied to data files, to compute the value of the above mentioned quantities, at any frequency from the range of 80MHz - 3000 MHz at 1 MHz step, in relation with the respective values at several frequencies given by the manufacture. This interference is achieved by “scipy.interpolate” library which is included in the function “AFplot ()” that we created for this purpose. A similar calculation process through the cubic linear interpolation is followed for the calculation and displaying of the diagram "Cable's Attenuation". Figure 5.10 and figure 5.11 are relate to the charts of Antenna Factor and Cable's Attenuation for the antenna PCD8250 and ARC Both Cables respectively, as calculated and displayed by the presented software.

Figure 5.12 PCD8250 Antenna Factor Chart

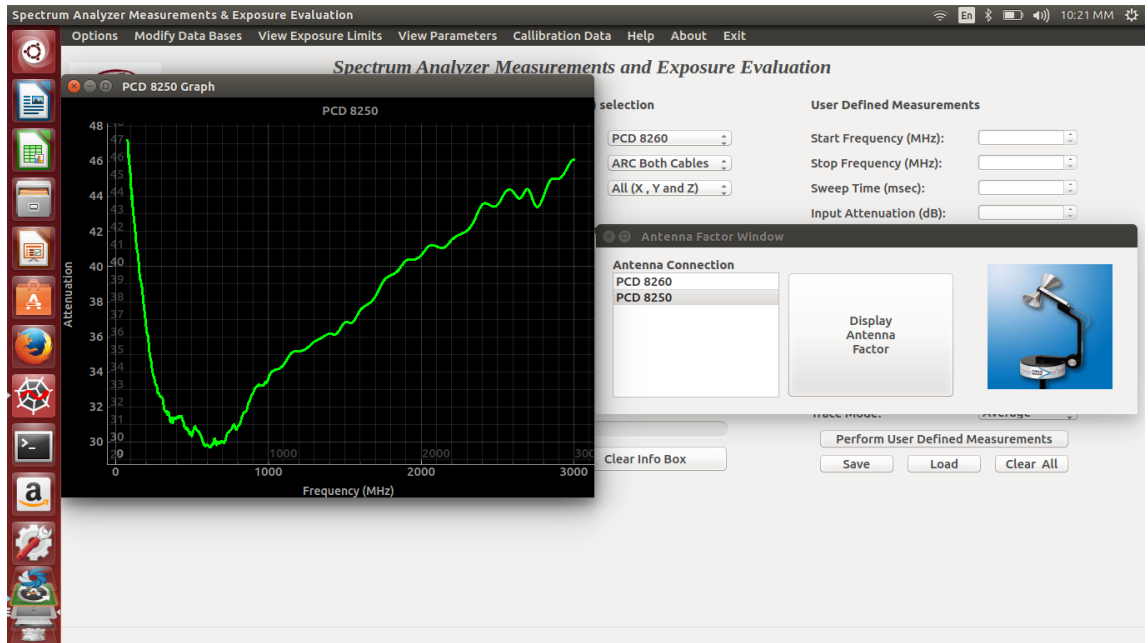
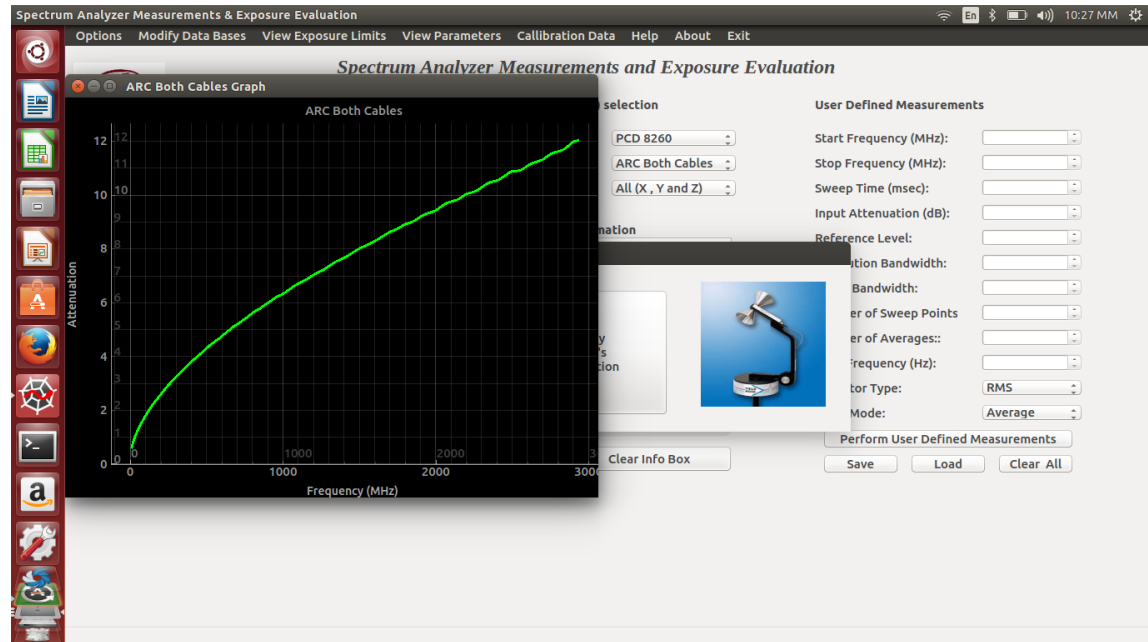

Figure 5.13 ARC Both Cables Attenuation Chart



5.12 Insert spectrum analyzer

The software presented, besides the possibility of entering the program of different types of antennas and cables, also offers the feature of input different models of spectrum analyzers. This feature is available through the menu in the upper part of the field “Modify Databases”. After selecting “Update spectrum Analyzer’s Data” the “Update SA Data” window appears, from where we can see the list of spectral analyzers already contained in our software. From this area, we can insert and delete a spectrum analyzer data. Suppose we want to insert the R&S FSH3 spectrum analyzer. We will select “Insert SA” and the corresponding window will appear, from which we are invited to add the corresponding “ods” file containing the spectral analyzer data, such as manufacturer, model, SCPI commands, etc. Information and details on how this file should be written can be found at the “Help” field in the menu at the top of the screen. We can also optionally select an image of the spectrum analyzer.

Figure 5.14 Insert spectrum analyzer data process

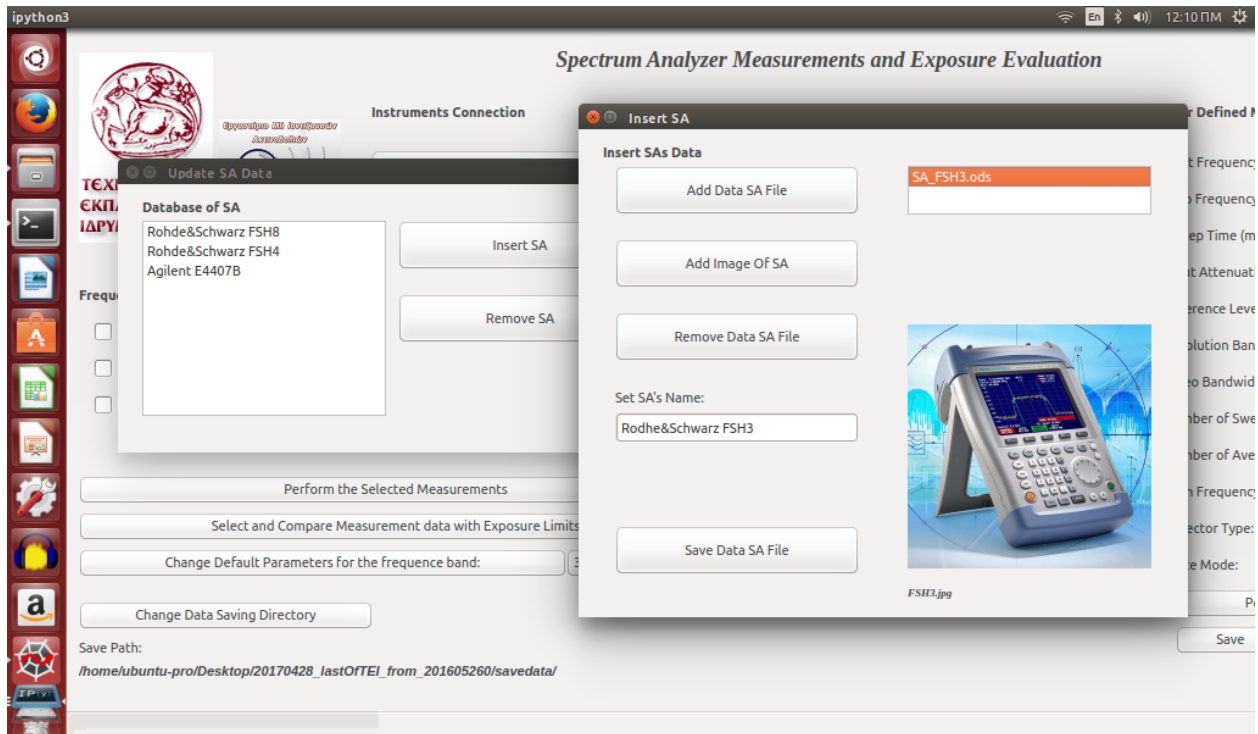

The figure 5.12 above shows the relative window “Insert SA”. After entering all the necessary data, we press the “Save Data SA File” button and all data are stored into software database. After that, the software has the ability to automatically recognize if such a spectrum analyzer is connected to the computer and the software automatically loads the SCPI commands needed to perform the measurements.

Chapter 6 - Using presented software to perform measurements

6.1 Connection of measurement equipment and software

In this chapter, the process of real measurement carried out with the presented software is analyzed. In order to perform these measurements, the equipment of the Non-Ionizing Radiation Laboratory (NIRL) of Technological Educational Institute of Crete was used. This equipment consists of a spectrum analyzer R&S FSH8, a dipole type antenna, model ARC-PCD8250 (30MHz - 3GHz), an antenna rotator from Austrian Research Centers (ARC), a laptop running Ubuntu 14.04 operating system and includes the developed software and ARC Both Cables. The ARC antenna rotator used since an omnidirectional antenna is not available in NIRL laboratory. The step motor of the ARC-PCD8250 antenna rotator is controlled by an Arduino board (the original rotator manufacturer board has been replaced in NIRL laboratory). More information about arduino boards and the ways of programming them can be found in Arduino official webpage [72]. All measurements were performed in an open area, at the courtyard of TEI of Crete in Heraklion on 27 April 2017.

Figure 6.1 Chart of NIRL equipment connection for performing measurements

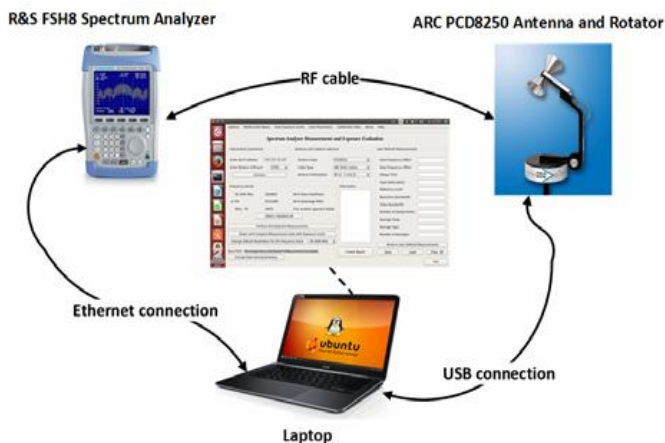

For measurements performing, procedures and conditions that are presented in Chapter 3 and relating to the methodology of EMF measurements, have been followed. As is shown in the

above chart, the spectrum analyzer is connected via the ARC Cable with the antenna. The antenna is mounted on the rotator and is connected through the second ARC Cable. Also, the ARC Rotator is connected via USB cable to Laptop which contains the software while the spectrum analyzer, is network connected via UTP cat.6 cable to the Ethernet port of Laptop.

Figure 6.2, 6.3 The instrumentation of NIRL that used for the EMF measurement process

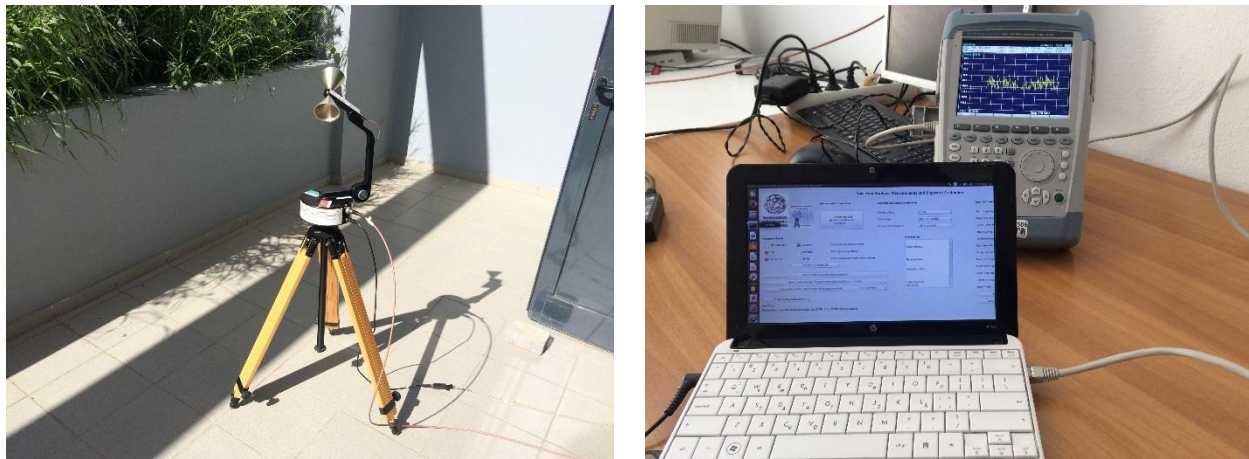

From field "Antenna and Cable (s) selection", the antenna type and the cables used as well as the antenna polarization are selected. Thus, we choose the antenna PCD8250 and the ARC Both Cables and also the three mutually perpendicular polarizations X, Y and Z in order to simulate isotropic characteristics. Then the spectrum Analyzer and Antenna rotator must connect with the software. In the initial screen of the software we press the push-button "Instrument and Antenna Rotator Connection" and we are moving in the "Connection" Instrument" window. If the Analyzer is connected via network, we select "TCP" as the connection type, and at the input field of the IP Address of the spectral analyzer we add the IP of the instrument. This IP can be found and be modified in the settings of the spectrum analyzer. We also add the COM Port to which is attached the antenna rotator. In our case as shown in the figure 6.4 below, the IP Address 169.254.26.200 and COM1 Port are entered.

Figure 6.4 Instrument connection window

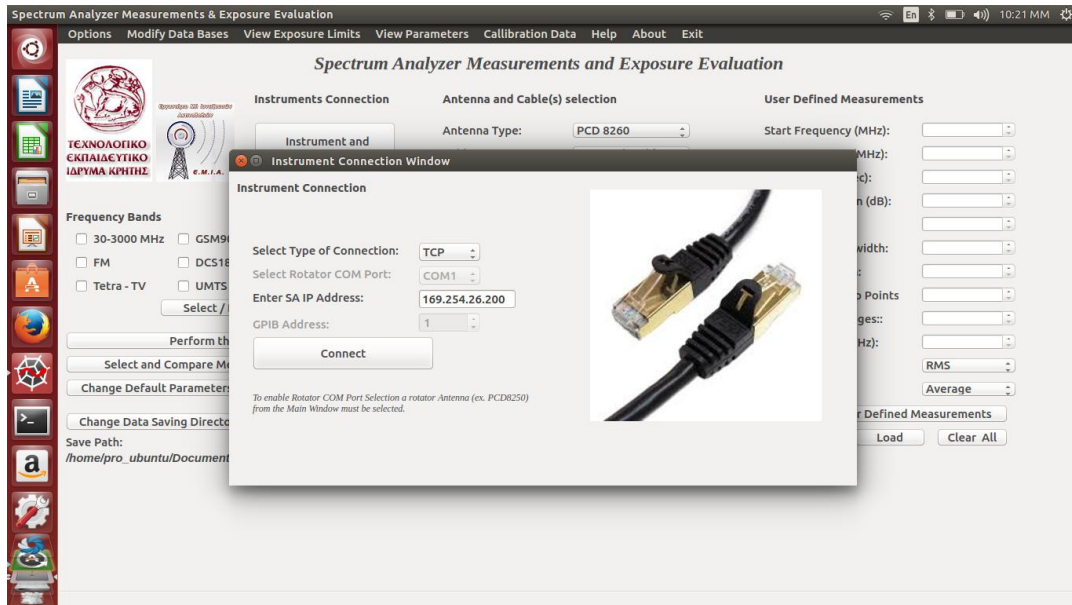

6.2 Perform measurements with predefined settings

After the instrument connection, the selection of desired for measurement bands, have to be selected. Assume we want to take measurements all frequency bands that are provided by the software. In the field of “Frequency Bands” selection, we check the respective options and press “Perform the Selected Measurements” button to begin the measurement process. We selected all the available frequency bands (FM, TETRA-TV, GSM900, DCS1800, UMTS, and Wi-Fi). The software begins the process from the first in line frequency band is scanning one by one the selected frequency bands at the three X, Y, and Z polarizations and finds the trace max peak value in all axes. The trace max peak value is used for setting the attenuation and the reference level.

For the storage of the total measurement data (files with trace data of the particular measurement on each band and for each axis as well as corresponding pictures of the spectrum analyzer display), a folder is created. The software automatically sets all the necessary parameters of the respective band, performs the measurement by sending commands to the SCPI spectrum analyzer via Ethernet and to the antenna rotator through USB, and collects all

necessary data in accordance to the procedure discussed in section 5.7. After the measuring process for the X axis is completed, the measurement data and a photo of the analyzer display are stored in the storage folder for further processing. Similar procedure is followed for each of the three X, Y and Z polarizations and for all bands that has been selected for measurement.

6.3 Evaluation of the EMF exposure

Once the measurements have been completed, we can process the data at any time. To analyze the data, we follow the procedure described in subchapter 5.8, by selecting the folder where the measurements are stored. The results of the analysis are stored in a file of “ods” type for each band separately. This file and also png files presenting charts of calculated quantities are stored into the same folder that contains the measurement data. During the analysis, the antenna factor and cable losses are taken into account for the necessary mathematical calculations. The following figure 6.5 presents the relative window after selection and analyzation of the measured bands.

Figure 6.5 Select and Compare data window – Analyze data procedure

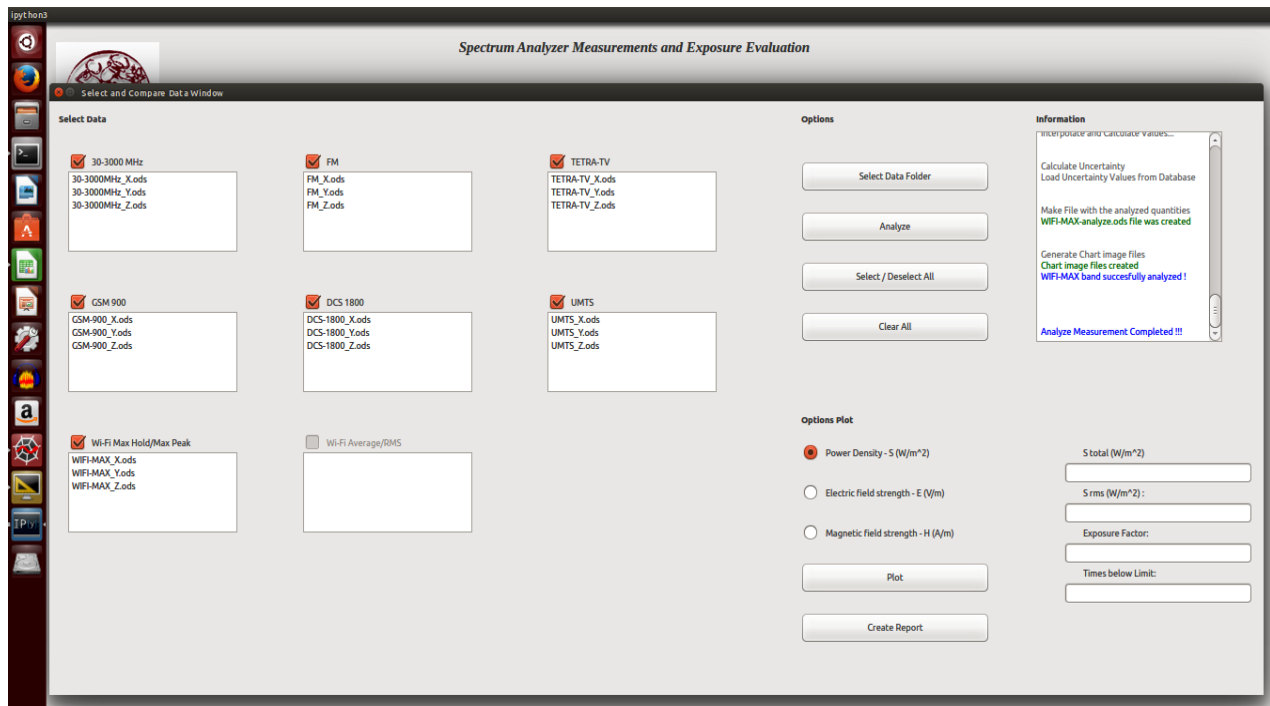

Now we can generate the diagram of one of the quantities S, H, E as a function of frequency, as well as the corresponding values, exposure ratio, exposure factor, uncertainty, etc by pressing the "Plot" button. Figure 6.6 displays the evaluation results for the FM band measurement and more specific the total Electric Field Strength (E_{total} V/m) in function of Frequency (f - MHz). Note that the red line in chart presents the safety limit of the specific quantity as established by the Greek legislation. Moreover, at the right side of the screen, calculated values of maximum E, total E, Exposure Factor and times below safety limits are displayed.

Figure 6.6 Chart of Frequency vs Electric Field Strength as generated by plot function

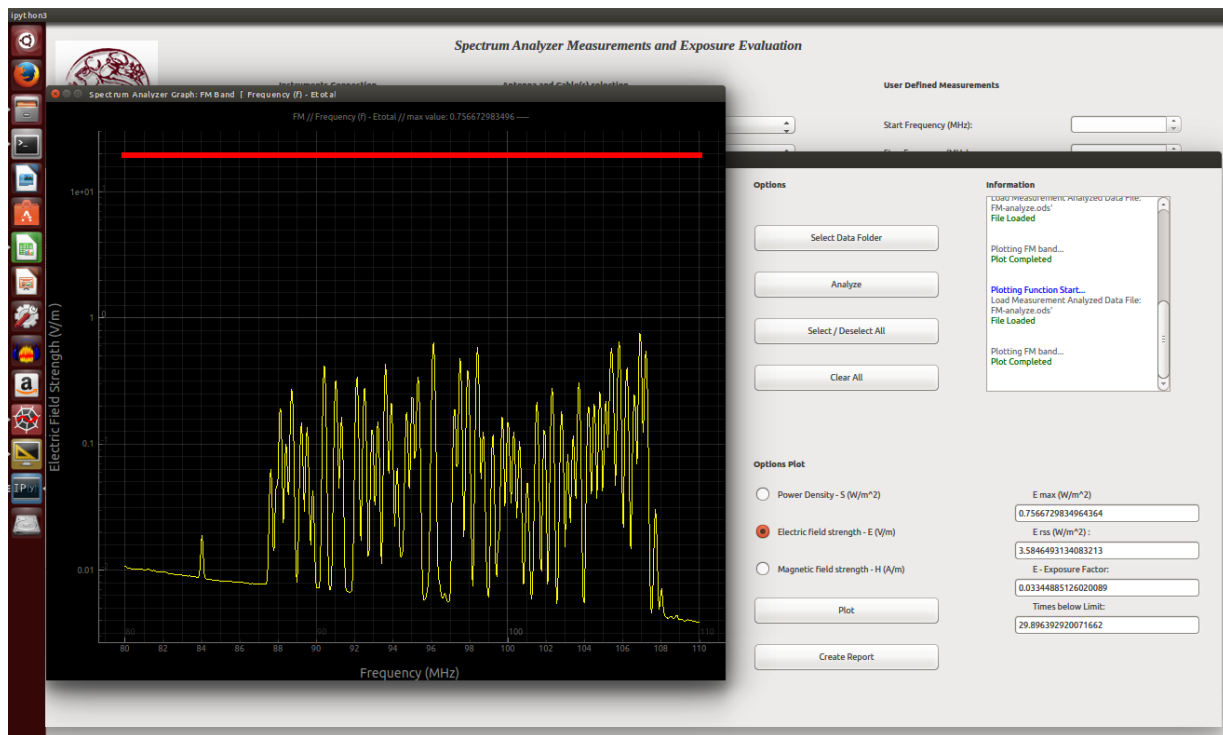

By pressing the button “Create Report”, the software automatically will create a report that includes the calculated results of the quantities S,E,H, the exposure factor and uncertainty of the measurement, charts of these quantities in all frequency bands as well as screenshots of the

spectrum analyzer during the measurement process. It is also including the area, the date, and the time the measurement took place, the instrumentation that used and many other information.

6.3 Results of the measurement

In this subchapter, all the results as received from the generated report are presented. These results refer to the power density S in W/m^2 , the Electric Field Strength in V/m , the Magnetic Field strength H in A/m , the exposure factor, the uncertainty and the times that the calculated quantity is below the limit.

6.3.1 Results of FM band measurement

In Figure 6.7, 6.8 and 6.9 the screenshots of the R&S FSH8 SA used for measurements taken in X, Y and Z polarizations of the receiving ARC-PCD8250 antenna in the FM band (80MHz-110MHz), are presented.

Figure 6.7, 6.8, 6.9 Screenshot from SA during the FM Band EMF measurement process

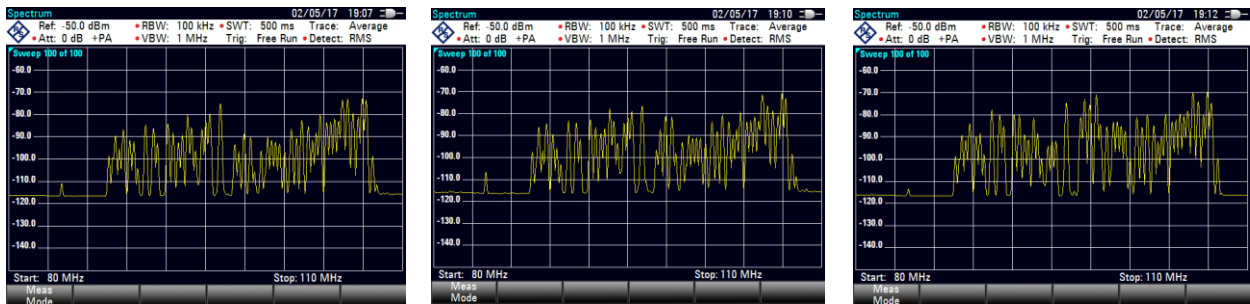

Next figures 6.10, 6.11 presents the charts of S_{total} and E_{total} in the same band as generated for the software in comparison with the established limits.

Figure 6.10, 6.11, Generated charts of S_{total} and E_{total} at FM band

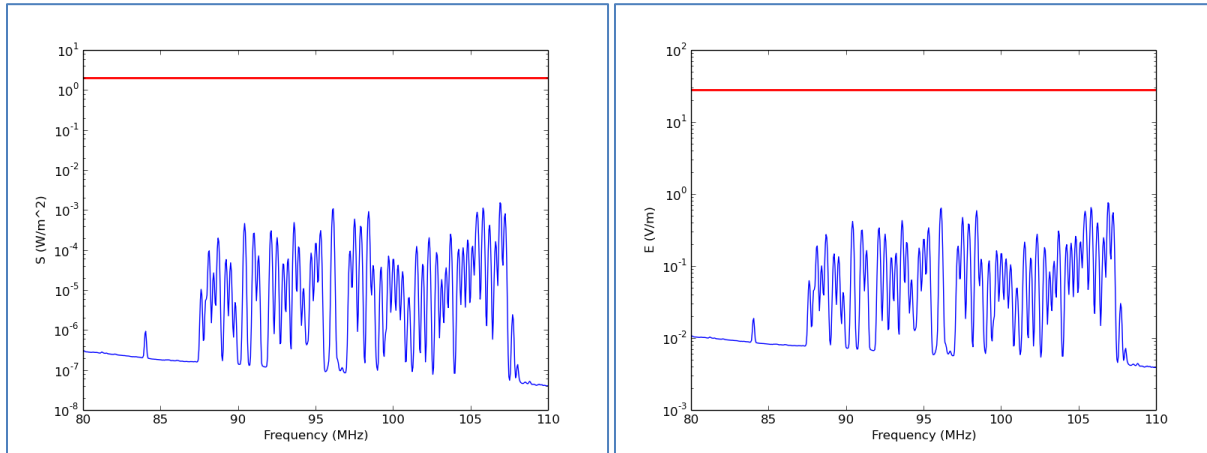

The following table 6.1 presents the respective results.

Table 6.1 Brief calculated measurement results for FM band

Bandwidth	30 MHz
Frequency zone	80 MHz – 110 MHz
Total Electric Field Strength	$6,17 \cdot 10^{-2}$ (V/m)
Total Power Density	$1,01 \cdot 10^{-5}$ (W/m ²)
Total Magnetic Field Strength	$1,6366 \cdot 10^{-4}$ (A/m)
Uncertainty	$\pm 2,49 \cdot 10^{-7}$
Exposure Factor	$8,34 \cdot 10^{-6}$
Times Below Limit	119.858,33

6.3.2 Results of TETRA-TV band measurement

In Figure 6.12, 6.13 and 6.14 the screenshots of the R&S FSH8 SA used for measurements taken in X, Y and Z polarizations of the receiving ARC-PCD8250 antenna in the TETRA-TV band (200 MHz-860 MHz), are presented.

Figure 6.12, 6.13, 6.14 Screenshot from SA during the TETRA-TV Band measurement

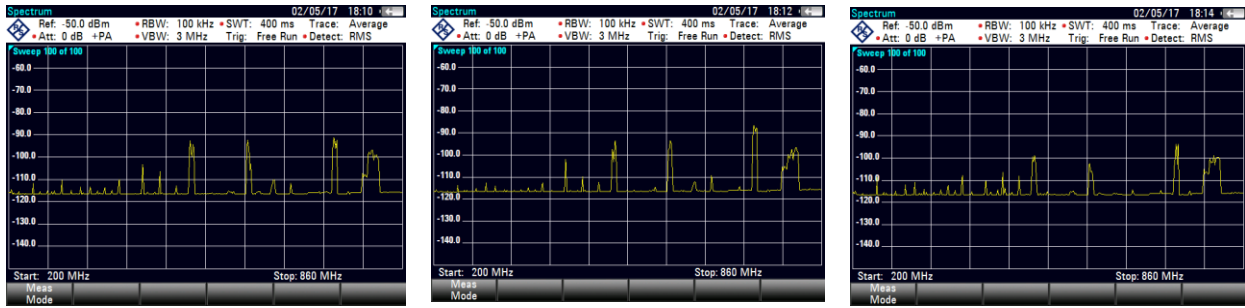

Next figures 6.15, 6.16 presents the charts of S_{total} and E_{total} in the same band as generated for the software in comparison with the established limits.

Figure 6.15, 6.16, Generated charts of S_{total} and E_{total} at TETRA-TV band

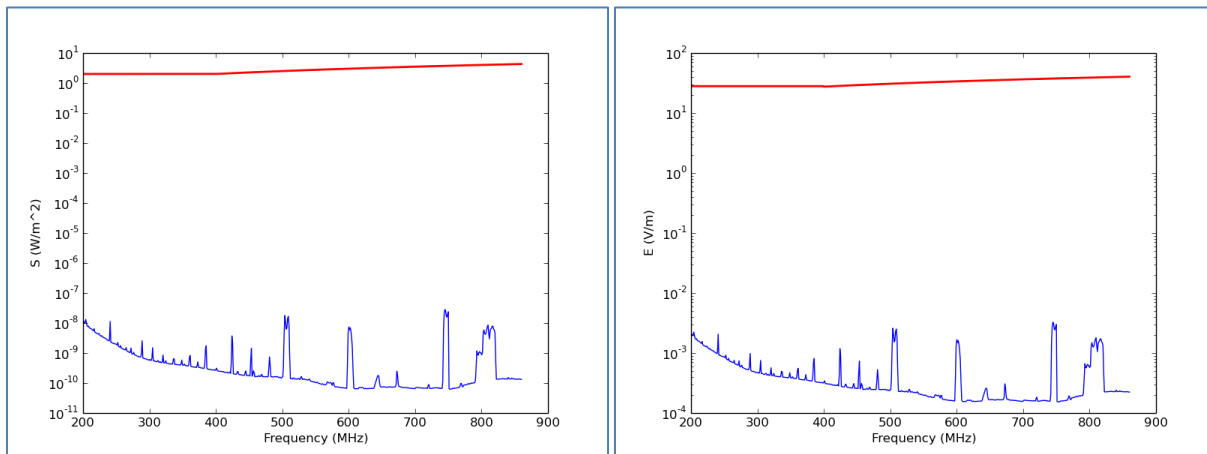

The following table 6.2 presents the respective results.

Table 6.2 Brief calculated measurement results for TETRA-TV band

Bandwidth	660 MHz
Frequency zone	200 MHz – 860 MHz
Total Electric Field Strength	$8,36 \cdot 10^{-3}$ (V/m)
Total Power Density	$1,86 \cdot 10^{-7}$ (W/m ²)
Total Magnetic Field Strength	$2,2176 \cdot 10^{-5}$ (A/m)
Uncertainty	$\pm 3,40 \cdot 10^{-9}$
Exposure Factor	$9,36 \cdot 10^{-8}$
Times Below Limit	$1,07 \cdot 10^7$

6.3.3 Results of GSM900 band measurement

In Figure 6.17, 6.18 and 6.19 the screenshots of the R&S FSH8 SA used for measurements taken in X, Y and Z polarizations of the receiving ARC-PCD8250 antenna in the GSM900 band (925 MHz - 960MHz), are presented.

Figure 6.17, 6.18, 6.19 Screenshot from SA during the GSM900 Band EMF measurement process

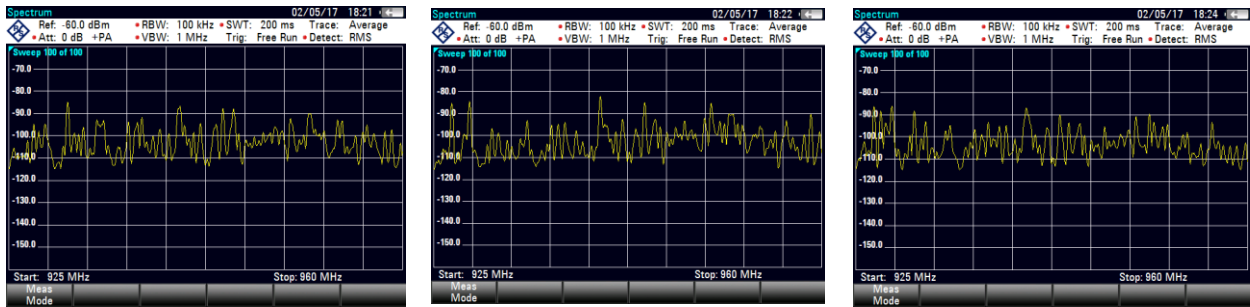

Next figures 6.20, 6.21 presents the charts of S_{total} and E_{total} in the same band as generated for the software in comparison with the established limits.

Figure 6.20, 6.21, Generated charts of S_{total} and E_{total} at GSM900 band

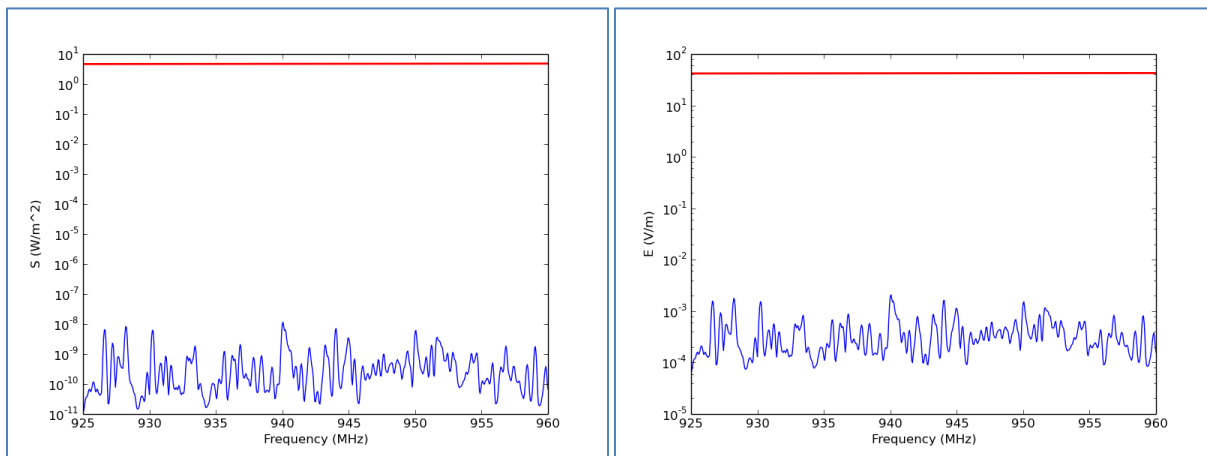

The following table 6.3 presents the respective results.

Table 6.3 Brief calculated measurement results for GSM900 band

Bandwidth	35 MHz
Frequency zone	925 MHz – 960 MHz
Total Electric Field Strength	$8,32 \cdot 10^{-3}$ (V/m)
Total Power Density	$1,83 \cdot 10^{-7}$ (W/m ²)
Total Magnetic Field Strength	$2,21 \cdot 10^{-5}$ (A/m)
Uncertainty	$\pm 1,27 \cdot 10^{-9}$
Exposure Factor	$6,60 \cdot 10^{-8}$
Times Below Limit	$1,51 \cdot 10^7$

6.3.4 Results of DCS1800 band measurement

In Figure 6.22, 6.23 and 6.24 the screenshots of the R&S FSH8 SA used for measurements taken in X, Y and Z polarizations of the receiving ARC-PCD8250 antenna in the DCS1800 band (1805 MHz – 1880 MHz), are presented.

Figure 6.22, 6.23, 6.24 Screenshot from SA during the DCS1800 Band measurement



Next figures 6.25, 6.26 presents the charts of S_{total} and E_{total} in the same band as generated for the software in comparison with the established limits.

Figure 6.25, 6.26, Generated charts of S_{total} and E_{total} at DCS1800 band

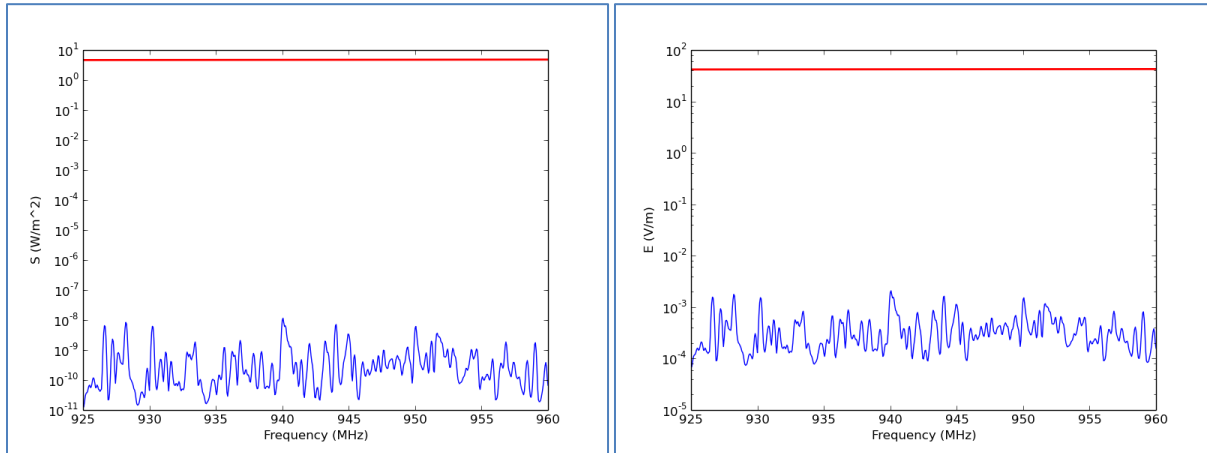

The following table 6.4 presents the respective results.

Table 6.4 Brief calculated measurement results for DCS1800 band

Bandwidth	75 MHz
Frequency zone	1805 MHz – 1880 MHz
Total Electric Field Strength	$1,12 \cdot 10^{-2}$ (V/m)
Total Power Density	$3,31 \cdot 10^{-7}$ (W/m ²)
Total Magnetic Field Strength	$2,97 \cdot 10^{-5}$ (A/m)
Uncertainty	$\pm 8,05 \cdot 10^{-10}$
Exposure Factor	$6,04 \cdot 10^{-8}$
Times Below Limit	$1,66 \cdot 10^7$

6.3.5 Results of UMTS band measurement

In Figure 6.27, 6.28 and 6.29 the screenshots of the R&S FSH8 SA used for measurements taken in X, Y and Z polarizations of the receiving ARC-PCD8250 antenna in the UMTS band (2110 MHz – 2170 MHz), are presented.

Figure 6.27, 6.28, 6.29 Screenshot from SA during the UMTS Band measurement process

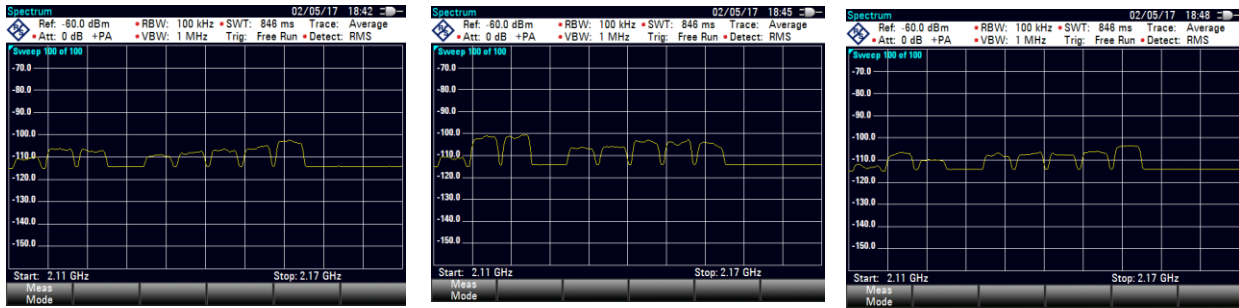

Next figures 6.30, 6.31 presents the charts of S_{total} and E_{total} in the same band as generated for the software in comparison with the established limits.

Figure 6.30, 6.31, Generated charts of S_{total} and E_{total} at UMTS band

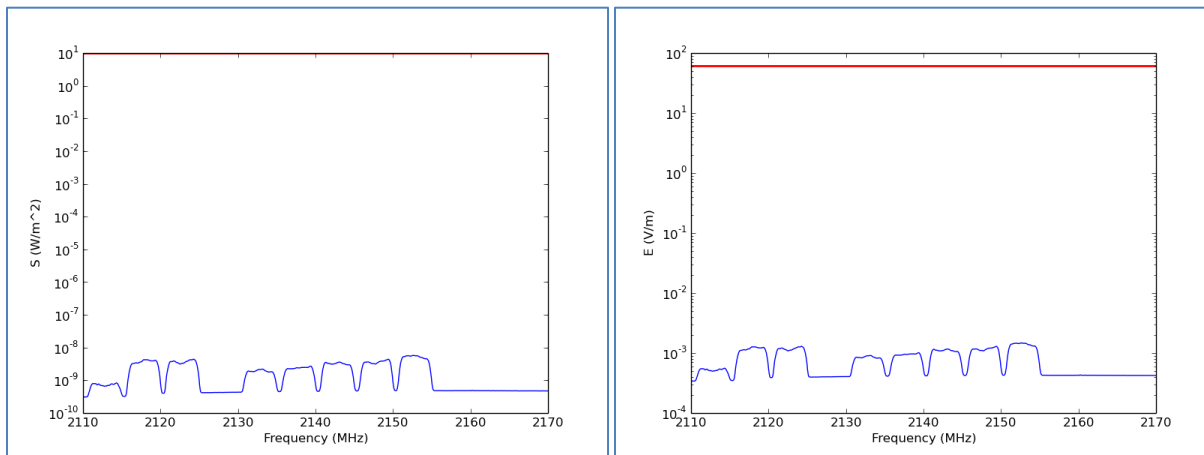

The following table 6.5 presents the respective results.

Table 6.5 Brief calculated measurement results for UMTS band

Bandwidth	60 MHz
Frequency zone	2110 MHz – 2170 MHz
Total Electric Field Strength	$1,54 \cdot 10^{-2}$ (V/m)
Total Power Density	$6,33 \cdot 10^{-7}$ (W/m ²)
Total Magnetic Field Strength	$4,09 \cdot 10^{-5}$ (A/m)

Uncertainty	$\pm 1,16 \cdot 10^{-9}$
Exposure Factor	$1,08 \cdot 10^{-7}$
Times Below Limit	$9,26 \cdot 10^6$

6.3.6 Results of Wi-Fi band measurement

In Figure 6.32, 6.33 and 6.34 the screenshots of the R&S FSH8 SA used for measurements taken in X, Y and Z polarizations of the receiving ARC-PCD8250 antenna in the Wi-Fi band (2500MHz-2600MHz), measured with the configuration of detector type to RMS and trace mode to average, are presented.

Figure 6.32, 6.33, 6.34 Screenshot from SA during the Wi-Fi Band measurement process



Next figures 6.35, 6.36 presents the charts of S_{total} and E_{total} in the same band as generated for the software in comparison with the established limits.

Figure 6.35, 6.36, Generated charts of S_{total} and E_{total} at Wi-Fi band

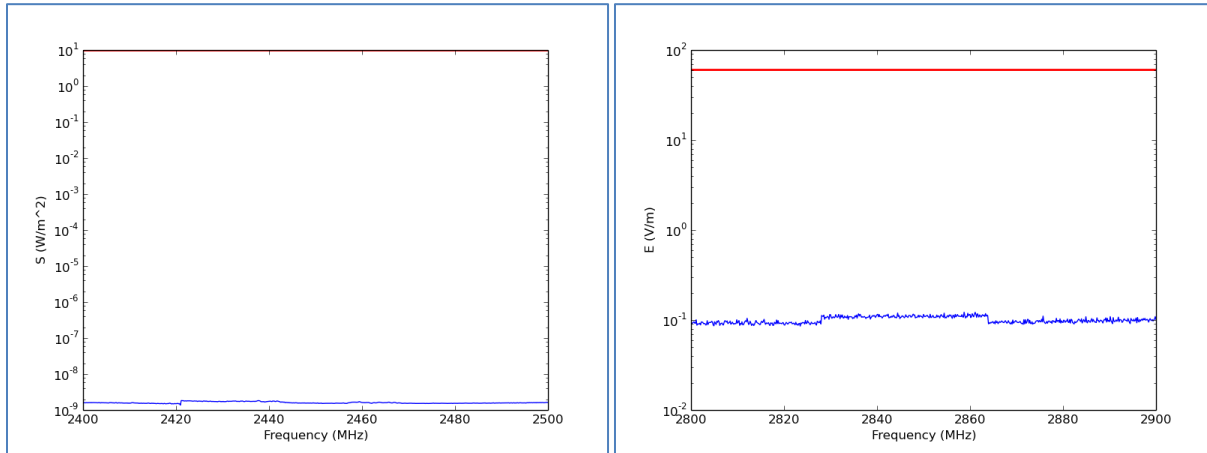

The following table 6.6 presents the respective results.

Table 6.6 Brief calculated measurement results for Wi-Fi band

Bandwidth	100 MHz
Frequency zone	2400 MHz – 2500 MHz
Total Electric Field Strength	$1,35 \cdot 10^{-2}$ (V/m)
Total Power Density	$4,86 \cdot 10^{-7}$ (W/m ²)
Total Magnetic Field Strength	$3,58 \cdot 10^{-5}$ (A/m)
Uncertainty	$\pm 7,77 \cdot 10^{-10}$
Exposure Factor	$8,28 \cdot 10^{-8}$
Times Below Limit	$1,21 \cdot 10^7$

In the above diagrams of this measurement, we observe that almost no signal appears. This is because the measurement was made away from a 2.4 GHz router and because the wireless network was not being used at the specific time by any user. For this reason, we conducted another measurement for Wi-Fi band with the detector type in Max Peak and the trace mode at max Hold. Also during the measurement, we used Wi-Fi on a router about 20 meters away from the receiving antenna.

In Figure 6.37, 6.38 and 6.39 the screenshots of the R&S FSH8 SA used for measurements taken in X, Y and Z polarizations of the receiving ARC-PCD8250 antenna in the Wi-Fi band (2500MHz-2600MHz measured with the configuration of detector type to Max Peak and trace mode to Max Hold), are presented.

Figure 6.37, 6.38, 6.39 Screenshot from SA during the Wi-Fi Band measurement process



Next figures 6.40, 6.41 presents the charts of S_{total} and E_{total} in the same band as generated for the software in comparison with the established limits.

Figure 6.40, 6.41, Generated charts of S_{total} and E_{total} at Wi-Fi band

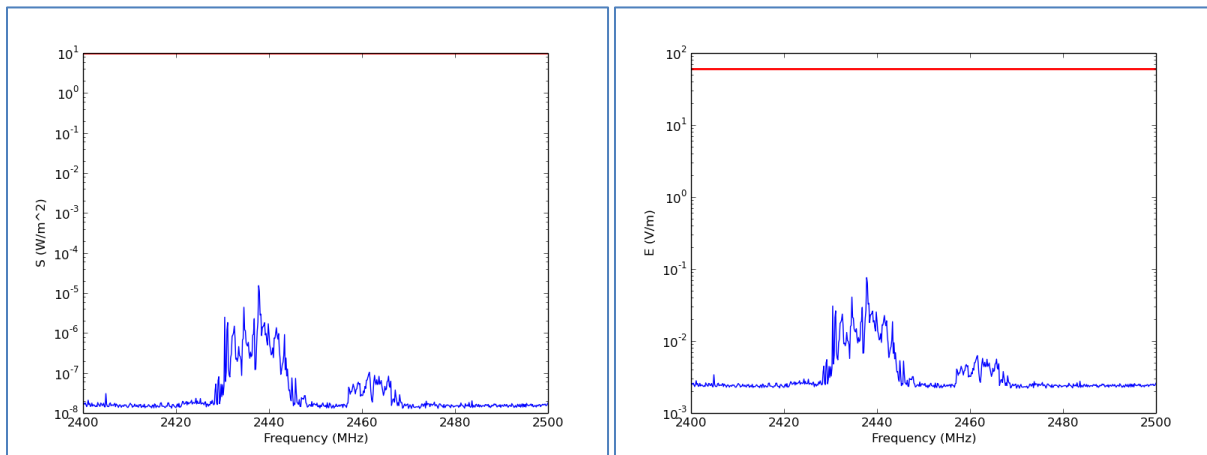

The following table 6.7 presents the respective results.

Table 6.7 Brief calculated measurement results for Wi-Fi band

Bandwidth	100 MHz
Frequency zone	2400 MHz – 2500 MHz
Total Electric Field Strength	0,13 (V/m)
Total Power Density	$4,78 \cdot 10^{-5}$ (W/m ²)
Total Magnetic Field Strength	$3,45 \cdot 10^{-4}$ (A/m)
Uncertainty	$\pm 5,15 \cdot 10^{-7}$
Exposure Factor	$8,59 \cdot 10^{-6}$
Times Below Limit	116.378,42

6.3.7 Estimate the exposure to EMF of measurement in multi-band field

As stated in the second chapter, in order to estimate the exposure to electromagnetic radiation, the sum of the rates of power densities, or electric field squares or magnetic field squares, to the maximum permissible reference levels at each frequency, should be calculated. This sum is also known as a multi-source exposure factor and must be less than 1 value (0 dB), in order to be complied with the reference levels and therefore the basic restrictions.

From the calculations of the software the total values of the measured quantities are presented in table 6.7.

Table 6.8 Brief calculated measurement results for multi-band field

Total Electric Field Strength	0,16 (V/m)
Total Power Density	$6,67 \cdot 10^{-5}$ (W/m ²)
Total Magnetic Field Strength	$4,21 \cdot 10^{-4}$ (A/m)
Total Uncertainty	$\pm 5,73 \cdot 10^{-7}$
Total Exposure Factor	$1,85 \cdot 10^{-5}$
Times Below Limit	54.077,86

The total exposure factor in multi-band field is $EF_{\text{total}} = 3,3471 \cdot 10^{-2} \leq 1$

We observe that the multi-source exposure factor is less than one unit ($EF_{\text{total}} \leq 1$), thus, exposure levels to electromagnetic radiation in the specific measurement are within the legislative safety limits.

Chapter 7 - Conclusions and Future Work

In this master thesis, a software developed for performing EMF measurements and evaluating compliance with exposure limits was described. Moreover, measurement in different frequency band of range 80 MHz – 3 GHz were made. For these measurements, the appropriate equipment of the Non-Ionizing Radiation Laboratory (NIRL) of Technological Educational Institute of Crete was used. The described software was exclusively implemented with open and free source tools and can support different types of spectrum analyzers, antennas and cables, and different kind of EMF measurements. In addition, modularity of the software allows for an easy extension with new instrumentation.

The software automatically identifies the connected spectrum analyzer and loads the appropriate communication commands from its database, of course if that spectrum analyzer exists in the software database. It also supports serial port programming commands for the rotation of the receiving antenna for measuring at different polarizations providing better appreciation of the incident EMF, if a proper rotator and antenna are used. The developed GUI provides convenience and handiness even by novice users, since it fully automates measurement process at predefined modern wireless communication frequency bands, as well as processing, calculation, estimation and evaluation of measurement results. Moreover, automatic report implementation can save several hours of valuable time.

Finally, using predefined settings to the spectrum analyzer (according to the widely-adopted measurement protocols), ensures reliability of the whole measurement and evaluation process, for one of the major issues that concern the modern society; the risk from the exposure to non-ionizing radiofrequency electromagnetic radiation.

The use of exclusively open source tools for the development of this software has proved challenging. The described software is running under 32 bit and 64 bit Ubuntu environment, and other versions have also been developed for 32 and 64 bit MS Windows environment (of course with some differences in Python programming commands and using the appropriate libraries).

Future work may introduce more options which will make the software more flexible with the use of different kind of instrumentation and for different kind of EMF measurements, in

order to give to the final user all the benefits that are related to the use of open and free source programming tools, i.e., customizability, community support, low hardware demands, auditability, low cost compared with commercial products etc. Moreover, measurement and evaluation of results for civil aviation approach radar, which requires specific procedure and calculations, can be introduced.

References

- [1] G. DJ, Introduction to electrodynamics 3rd edition, San Fransisco: Calif. Pearson Benjamin Cummings, 2008.
- [2] J. Lucas, "Live Science," Live Science, 12 03 2015. [Online]. Available: <http://www.livescience.com>.
- [3] E. Board, Concise Dictionary Of Physics, V&S Publishers, 2012, p. 146.
- [4] E. Britanica, "Merriam-Webster," 6 8 2015. [Online]. Available: <https://www.merriam-webster.com>.
- [5] M. Manikas, Study and experimental determination of levels of non-ionizing radiation (100KHz-3GHz) in different geographical areas, S. Kotsopoulos, Ed., Patra: Univercity of Patra, 2011.
- [6] N. Faruk, A. Ayeni and Y. A. Adediran, "On the study of empirical path loss models for accurate predicrion of TV signal for secondary users," *Progress In Electromagnetics Research B*, no. 49, pp. 155-176, 2013.
- [7] A. Lazakidou, K. Siassiakos and K. Ioannou, Wireless Technologies for Ambient Assisted Living and Healthcare: Systems and Applications, New York: Medical Information Science Reference, 2010, p. 33.
- [8] D. P. Agrawal and Q.-A. Zeng, "Instroduction to Wireless & Mobile Systems (4th edition)," Cengage Learning, USA, 2016.
- [9] R. C. V. Macario, Modern Personal Radio Systems, United Kindom: The Institution of Electrical Engineers, 1996.
- [10] S. Tindal, "ZDNet," 8 12 2008. [Online]. Available: <http://www.zdnet.com>. [Accessed 30 1 2017].
- [11] "wikipedia," 25 01 2017. [Online]. Available: <https://en.wikipedia.org>. [Accessed 30 01 2017].
- [12] M. Sauter, From GSM to LTE: An Introduction to Mobile Networks and Mobile Broadband, UK: Wiley, 2011, p. 117.

- [13] I. Soldo and K. Malaric, "Wi-Fi Parameter Measurements and Analysis," in *9th International Conference*, Smolenice, Slovakia, 2013.
- [14] "Terns, Tech," 11 03 2014. [Online]. Available: www.techterms.com. [Accessed 31 01 2017].
- [15] P. Heltzel, *Complete Wireless Home Networking*, Prentice Hall, 2003.
- [16] D. Poljak, *Human Exposure to Electromagnetic Fields*, United Kindom: WIT Press, 2004, p. 123.
- [17] R. Habash, *Electromagnetic Fields and Radiation: Human Bioeffects and Safety*, New York: Marcel Dekker Inc., 2002, pp. 102, 224-225.
- [18] C. Sage and D. O. Carpenter, "Public health implications of wireless technologies," *Pathophysiology*, vol. 16, no. 2-3, pp. 233-246, August 2009.
- [19] M. Otto and K. E. Muhlendahl, "Electromagnetic fields (EMF): Do they play a role in," *Science Direct*, vol. 210, pp. 635-644, 2007.
- [20] CDC, *Principles of Epidemiology in Public Health Practice*, 3rd ed., Atlanta: U.S.Department of Health and Human Services, 2012, pp. 1-2.
- [21] M. Porta, *A Dictionary on Epidemiology*, 6th ed., M. Porta, Ed., Oxford Univercity Press, p. 95.
- [22] J. Swason and D. C. Renew, "Power-Frequency Fields and People," *Engineering Science and Educational Journal*, pp. 71-79, 1994.
- [23] WHO, 2 2017. [Online]. Available: www.who.int.
- [24] ICNIRP, "Guidelines for limiting exposure to time-varying electric, magnetic and electromagnetic fields (Up to 300GHz)," *Health Physics*, vol. 74, no. 4, April 1998.
- [25] E. Portal, 2 2017. [Online]. Available: <https://www.emf-portal.org>.
- [26] EU Council, "Recommendation of the Council of July 12, 1999 relative to the exposure Limitation of the public to the elecromagnetic fields(from 0 Hz to 300 GHz)," 1999/519/CE, 1999.
- [27] Greek legislation, "Common Ministerial Decision - Protection measures for the exposure of the general public to all land based antenna stations," vol. B, no. Act. No.1105, 6 9 2000.

- [28] Greek legislation, "Common Ministerial Decision - Protection measures for exposure of the general public to all low frequency electric and magnetic fields emitting devices," vol. B, no. Act. No.512, 25 4 2002.
- [29] Greek legislation, "Law 3431, About Electronic Communications and other orders," vol. No. A, no. Act. No. 13, 3 2 2006.
- [30] Narda, "Basic insights: Safety in electric, magnetic and electromagnetic fields," Narda Safety Test Solutions, USA.
- [31] O. R. Fornells, "Automation Platform for Radio Spectrum Measuresw," Barcelona, 2014.
- [32] A. Technologies, "Spectrum Analysis Basics," USA, 2006.
- [33] J. Gorin, "Detector Selection for Spectrum analyzer Measurements," *Defence Electronics*, pp. 32-38, February 2003.
- [34] D. Stratakis, A. Miaoudakis, T. Xenos and V. Zacharopoulos, "Electromagnetic Exposure Compliance Estimation Using Narrowband Directional Measurements," *Radiation Protection Dosimetry*, vol. 130, no. 3, pp. 331-336, February 2008.
- [35] D. Stratakis, A. Mioudakis, T. Xenos and V. Zacharopoulos, "Overall Uncertainty Estimation in Multiple Narrowband in Situ Electromagnetic Field Measurements," *IEEE Transactions on Instrumentation and Measurement*, vol. 58, no. 8, pp. 2767-2779, August 2009.
- [36] D. Stratakis, A. Miououdakis, T. Xenos and V. Zacharopoulos, "On the Spatial Averaging of Multiple Narrowband Electromagnetic Field Measurements. Methods and Uncertainty Estimation," *IEEE Transactions on Instrumentation and Measurements*, vol. 58, no. 8, pp. 1520-1536, June 2010.
- [37] W. Mullner, G. Neubauer and H. Haider, "Add3D, a new technique for precise power flux density measurements at mobile communications base stations," *ARC Serbersdorfresearch GmbH*, February 2000.
- [38] I. C95.3, "IEEE Recommended practice for the measurement of potentially hazardous electromagnetic fields, RF and microwave," 1991.
- [39] CENELEC EN 50166-2, "Human exposure to electromagnetic fields. High frequency (10 KHz to 300 GHz)," 1995.

- [40] Hellenic Organization for Standardization, "EN - 61566 - Measurement of exposure to radio frequency electromagnetic fields - Field strength in the frequency range 100 KHz to 1 GHz," Athens, 1998.
- [41] Revised ECC Recommendation (02)04, "Measuring Non-Ionizing Electromagnetic Radiation (9 KHz - 300 GHz)," October 2003.
- [42] D. Stratrakis, T. Xenos, B. Zacharopoulos, N. Farsaris, I. Zacharopoulou and C. Katsidis, "Automation in Electromagnetic Field Measurements," in *TEMU 2006*, Heraklion, Crete, Greece, 2006.
- [43] A. Technologies, "Agilent Spectrum and Signal Analyzer Measurements and Noise 5966 4008," Agilent Technologies, USA, 2012.
- [44] K. Pantelaki, "Study of Electromagnetic Field Measurement Methodology of pulsed rotating high-power signals," Heraklion, 2016.
- [45] R. & Schwarz, "Tackling the Challenges of Pulsed Signal Measurements," Rohde & Schwarz, Germany, 2008.
- [46] R. FSP, "Power Measurement on Pulsed Signals with Spectrum Analyzers," Rohde&Schwarz FSP, Germany, 2003.
- [47] Greek legislation, "How to perform measurements for compliance with the safety exposure limits public to electromagnetic radiation from each antenna," 2008.
- [48] ISO/BIPM, "Evaluation of measurement data - Guide to the Expression of Uncertainty in Measurement," JCGM, 2008.
- [49] UKAS, "The Expression of Uncertainty in EMC Testing," 2002.
- [50] G. O. Standards, "Hellenic Standard," Athens, 2006.
- [51] E. C. C. (ECC), "Measuring Non-Ionizing Electromagnetic Radiation (9 kHz – 300 GHz)," 2003.
- [52] K. Fogel, *Producing Open Source Software*, 2nd edition ed., 2017.
- [53] 2017. [Online]. Available: <http://www.fsf.org/>.
- [54] B. Smith, Free Software Foundation, Inc., 2007. [Online]. Available: <http://www.gnu.org/licenses/quick-guide/gplv3..>

- [55] ELLAK, "https://mathe.ellak.gr/?p=15," March 2017. [Online]. Available: <https://mathe.ellak.gr/?p=15>.
- [56] B. Smith, "A Quick Guide to GPLv3," Free Software Foundation, 2007.
- [57] F. S. Foundation, "GPLv3 Final Rationale," Free Software Foundation, Inc., USA, 2007.
- [58] C. Ltd, 2017. [Online]. Available: www.ubuntu.com.
- [59] U. w. community, 2017. [Online]. Available: <https://wiki.ubuntu.com/>.
- [60] P. S. Foundation, 2017. [Online]. Available: <https://www.python.org/>.
- [61] N. Aggelidakis, Introduction to computer programming with Python, 1st Edition ed., Heraklion, 2015, p. 5.
- [62] Wikipedia, "Python Software Foundation License," [Online]. Available: https://en.wikipedia.org/wiki/Python_Software_Foundation_License. [Accessed 21 March 2017].
- [63] P. S. Foundation, "History and License," [Online]. Available: <https://docs.python.org/3/license.html>. [Accessed 21 March 2-17].
- [64] R. Stalman, "Various Licences and Comments about Them, new Python licence," Free Software Foundation, 2017.
- [65] P. Authors, "PyVISA: Control your instruments with Python," 2016. [Online]. Available: <http://pyvisa.readthedocs.io>.
- [66] P. Authors, "PyVISA-py: Pure Python backend for PyVISA," 2016. [Online]. Available: <https://pyvisa-py.readthedocs.io>.
- [67] SCPI Consortium, "Standard Commands for Programmable Instruments (SCPI)," vol. 1, May 1999.
- [68] "PyQT4 Reference Guide," [Online]. Available: <http://pyqt.sourceforge.net/Docs/PyQt4/>.
- [69] M. Summerfield, in *Rapid GUI Programming*, P. Hall, Ed., Upper Saddle River, NJ, 2008.
- [70] T. Shejbal, M. Petkov, T. Zalabsky, J. Pidanic and Z. Nemeč, "Remote Control Software for Rohde & Schwarz Instruments," *International Journal of Electrical, Electronic Science and Engineering*, vol. 7, no. 10, 2013.
- [71] E. Lunca, Member, APCBEES, A. Salcenau and S. Ursache, "AutoMated measurement and

Monitoring of the Electromagnetic Fields from GSM Systems," *Journal of Clean Energy Technologies*, vol. 1, no. 3, pp. 174-177, July 2013.

[72] Arduino, "Arduino examples and Tutorials," [Online]. Available:
<https://www.arduino.cc/en/Tutorial/HomePage>.